

Connex500/350 3D Printer System



Copyright

Copyright © 2014 Stratasys Ltd. All rights reserved.

This documentation contains proprietary information of Stratasys Ltd. This information is supplied solely to assist authorized users of Connex500/350 3D printing systems. No part of this document may be used for other purposes, and it may not be disclosed to other parties.

The specifications on which this document is based are subject to change without notice.

No part of this book may be reproduced in any form or by any means, nor stored in a database or retrieval system, without prior permission in writing from Stratasys Ltd.

If this document is distributed as a PDF file, you may print it for internal use.

Trademarks

The following are registered trademarks of Stratasys Ltd.: Stratasys[®], Objet[®], FullCure[®].

The following are trademarks of Stratasys Ltd.: Connex, Connex500, Connex350, Objet260 Connex, PolyJet, Objet Studio, Job Manager.

Microsoft and Microsoft XP are trademarks of Microsoft Corporation.

All names of products and services cited in this book are trademarks or registered trademarks of their respective companies.

FCC Compliance

The equipment referred to in this guide has been tested and found to comply with the limits for a Class A device pursuant to part 15 of the FCC rules. These limits provide reasonable protection against harmful interference when the equipment is operated in a commercial environment. Objet 3D printing systems generate, use and can radiate radio-frequency energy and, if not installed and used in accordance with the instruction manual, may cause harmful interference to radio communications. Operation of this equipment in a residential area is likely to cause harmful interference, in which case the user will be required to correct the interference at his own expense.

The 3D printer referred to in this guide contains a transmitter module, FCC ID YH6-RFID.

NOTE: Stratasys is not responsible for radio or TV interference caused by unauthorized modification to this equipment. Such modification could void the user's authority to operate the equipment.

Equipment Recycling



In the European Union, this symbol indicates that when the last user wishes to discard a product, it must be sent to appropriate facilities for recovery and recycling. For information about proper disposal, check your purchase contract, or contact the supplier of the equipment.

Limitation of Liability

The product, software or services are being provided on an "as is" and "as available" basis. Except as may be stated specifically in your contract, Stratasys Ltd. expressly disclaims all warranties of any kind, whether express or implied, including, but not limited to, any implied warranties of merchantability, fitness for a particular purpose and non-infringement.

You understand and agree that Stratasys Ltd. shall not be liable for any direct, indirect, incidental, special, consequential or exemplary damages, including but not limited to, damages for loss of profits, goodwill, use, data or other intangible losses (even if Stratasys has been advised of the possibility of such damages), resulting from: (i) the use or the inability to use the product or software; (ii) the cost of procurement of substitute goods and services resulting from any products, goods, data, software, information or services purchased; (iii) unauthorized access to or alteration of your products, software or data; (iv) statements or conduct of any third party; (v) any other matter relating to the product, software, or services.

The text and drawings herein are for illustration and reference only. The specifications on which they are based are subject to change. Stratasys Ltd. may, at any time and without notice, make changes to this document. Stratasys Ltd., for itself and on behalf of its subsidiaries, assumes no liability for technical or editorial errors or omissions made herein, and shall not be liable for incidental, consequential, indirect, or special damages, including, without limitation, loss of use, loss or alteration of data, delays, or lost profits or savings arising from the use of this document.

Patents

This product is covered by one or more of the following U.S. patents:

5,386,500
5,519,816
5,695,708
6,259,962
6,569,373
6,644,763
6,658,314
6,850,334
7,183,335
7,209,797
7,225,045
7,300,619
7,364,686
7,369,915
7,479,510
7,500,846
7,604,768
7,628,857
7,658,976
7,685,694
7,725,209
7,896,639

Stratasys Ltd.

<http://www.stratasys.com>

DOC-13025

Revision Rev. A

March 2015



Contents

1	About This Guide	
	Using This Guide	1-2
	For More Information.....	1-2
	Terms Used in This Guide.....	1-3
2	Safety	
	Safety Features	2-2
	Symbols and Warning Labels	2-3
	Safety Guidelines	2-4
	Printer Installation	2-4
	Printer Operation	2-4
	UV Radiation	2-4
	Printer Maintenance	2-4
	Model and Support Materials	2-5
	UV Lamps	2-5
	First Aid for Working with Printing Materials.....	2-6
	Contact with Skin.....	2-6
	Contact with Eyes	2-6
	Ingestion.....	2-6
	Inhalation	2-6
	Waste Disposal	2-7
3	Introducing the Connex500/350 3D Printing System	
	Welcome to Connex.....	3-2
	Work Configurations.....	3-3
	Source Files	3-4
	STL Files	3-4
	SLC Files.....	3-4
	Connex Workflows.....	3-5
	Printing Materials	3-6
	Storage	3-6
	Shelf Life.....	3-6
	Exposure to Light.....	3-6
	Safety Considerations.....	3-7
	Disposal.....	3-7
	Work Environment.....	3-7
	Workstation Requirements.....	3-8
	Preparing Files for Use with Objet 3D Printing Systems	3-9
	Converting CAD Files to STL Format.....	3-9
	Converting CAD Files to SLC Format	3-9
	Objet Studio Software	3-10
4	Installing Objet Software	
	How to Install Software for the Connex 3D Printing System.....	4-2
	How to Uninstall Objet Studio.....	4-6

5 Using Objet Studio

Launching Objet Studio	5-3
Windows® 7 Security Warning.....	5-3
Objet Studio Interface	5-4
Ribbon Commands.....	5-6
Objet Studio Commands Menu.....	5-8
Model Tree Pane	5-8
Preparing Models for Production.....	5-9
OBJDF Files: Overview.....	5-9
Model Files	5-9
Placing Objects on the Build Tray	5-10
Opening Objet Tray Files.....	5-14
Quick-Access Model Commands.....	5-16
Copying and Pasting Objects.....	5-17
Selecting Objects	5-18
Splitting Objects into Components	5-19
Model-Material Settings	5-20
Changing the Model Material.....	5-21
Digital Materials	5-22
Assigning a Model Material to Objects	5-23
Surface Finish	5-24
Coating Objects.....	5-24
Assigning Properties to Hidden Objects.....	5-25
Positioning Objects on the Build Tray	5-26
Automatic Orientation.....	5-26
Automatic Placement.....	5-27
Manual Positioning	5-27
Model Orientation.....	5-28
Manipulating Objects on the Build Tray	5-29
Positioning Objects on the Z-Axis.....	5-29
Valid Object Placement.....	5-30
Using a Grid to Position Objects	5-31
Measurement Units	5-32
Setting Model Dimensions	5-33
Repositioning Objects	5-33
Changing an Object’s Orientation.....	5-35
Grouping and Ungrouping Objects.....	5-36
Freezing Model Orientation.....	5-38
Display Options.....	5-39
Viewing Objects.....	5-39
Screen Layout.....	5-41
Tray Perspective	5-42
Setting Object Colors.....	5-43
Loading Large Files.....	5-44
Large File Manipulation	5-44
Zoom Options	5-46
Handling Completed Trays.....	5-47
Tray Validation	5-47
Production Estimates	5-48
Printing Modes	5-49
E-mailing Objet Digital Files.....	5-50
Printing the Tray File	5-50

Applying Additional Objet Studio Features.....	5-53
Dividing Objects.....	5-53
Choosing the Support Strength	5-54
“Hollow” – Filling Models with Support Material.....	5-55
Displaying the Cross Section of Objects	5-56
Saving the Screen Display as an Image File.....	5-57
Exporting and Importing Objet Build Trays.....	5-58
Customizing Objet Studio	5-59
Creating a Quick Access Toolbar.....	5-59
Hiding the Ribbon	5-60
Display Colors	5-61
Keyboard Shortcuts	5-62
Setting User Preferences	5-63
Professional Mode Features	5-64
Default Settings	5-65
OpenGL Driver Configuration	5-66
Getting Additional Objet Studio Assistance.....	5-68
Objet Studio Version, Material Module and Licensed Features	5-68
Monitoring and Managing Print Jobs.....	5-70
Job Manager Screen	5-70
Setting the Printer Connection.....	5-72
Off-line Mode	5-73
Setting the Remote Printer Connection (Client Mode).....	5-75
Job Manager Commands	5-75
Configuring User Alerts.....	5-78
Printing the Tray	5-79
Additional Server Features.....	5-79
6 Operating & Maintaining the Connex500/350 3D Printer	
Starting the Connex Printer.....	6-2
Loading Model and Support Cartridges	6-4
Producing Models.....	6-5
Preparing the Printer	6-5
Printer Interface Color Key.....	6-7
Printing Indicators	6-8
Resuming Production After Printing has Stopped	6-9
Changing the Printing Material.....	6-11
Keeping the Printer in Idle Mode.....	6-16
Shutting Down the Printer	6-17

Maintaining the Printer	6-19
Routine Maintenance Schedule	6-19
Maintenance Counters	6-20
UV Lamp Check.....	6-22
Cleaning the Print Heads and the Roller	6-22
Cleaning and Replacing the Wiper	6-25
Pattern Test.....	6-27
Improving Print Quality	6-28
Cleaning the Roller Waste Collector and Inspecting the Roller Scraper	6-29
Replacing the Roller Scraper.....	6-32
Aligning the Print Heads.....	6-34
Calibrating (Optimizing) Print Heads.....	6-38
Replacing Print Heads	6-40
.....	6-49
Testing and Calibrating the UV Lamps.....	6-50
Calibrating the Load Cells.....	6-56
Replacing the Odor Filter	6-58
Replacing the UV Lamps.....	6-58
Built-in Tests.....	6-63
Replacing the Waste Container	6-68
Cleaning the Exterior Panels.....	6-70

7 Handling Printed Models

Removing Models After Printing	7-2
Removing the Support Material	7-2
Post-Printing Treatment for Models Printed with Objet VeroClear.....	7-4
Photo-Bleaching Instructions.....	7-4
Storing Models	7-5

1

About This Guide

Using This Guide.....	2
For More Information	2
Terms Used in This Guide.....	3

Using This Guide

This user guide provides instructions for installing, operating and maintaining Connex 3D printing systems. It explains how to use features, and provides practical examples to guide you as you use the system.

The text and figures in this guide are based on the Connex500 3D printer, printer software version 57.2 and Objet Studio software version 9.2.

This guide assumes that—

- all the hardware, software, and network components of your Connex system are installed, configured, and operating correctly.
- the operator has a working knowledge of the Windows[®] PC platform.

For More Information

Visit <http://www.stratasys.com/> for more details about Objet printer technology, products and consumables, and for service and support contacts.

For other documents that relate to Connex500/350 3D printing systems, and for this document in other languages, contact your regional Stratasys Customer Support office.

If you have any questions about the information presented in this document, or if you have any comments or suggestions for future editions, please send a message to c-support@stratasys.com.

Terms Used in This Guide

build tray	<p><i>In Objet Studio:</i> The surface displayed on the screen that represents the actual build tray in the printer.</p> <p><i>In the printer:</i> The surface upon which models are produced.</p>
cleaning fluid	Cleanser for flushing material feed tubes and the printing block, used to completely remove Model and Support material from the system before loading another type of material in the printer and before long-term shutdown. The cleaning fluid is supplied in standard material cartridges.
client/user workstation	The workstation on which Objet software is installed, used for preparing build trays for production on Objet printers. (There is no limit to the number of client workstations in the local network.)
Connex™	The technology of printing models by jetting multiple materials simultaneously from the print heads. This technology enables Connex500/350 printers to print in Digital Material mode.
Digital Material™	Combinations of model materials fabricated in the printer from the two basic model materials installed.
Digital Material Mode	The printer mode used to print a job using two different model materials. (This mode can also be used to eliminate the need for performing the Material Replacement procedure when printing with a single model material.)
host/server workstation	The workstation that interfaces directly with the Connex printer and is typically positioned next to it.
Job Manager™	The part of Objet Studio software that manages production jobs before they are sent to the Connex printer.
mixed part	Models whose parts are printed using more than one model material.
mixed tray	A build tray containing objects, each of which is designed to be printed using a different model material.
Model material	Material used for building models.
Objet Studio™	The software with which users prepare jobs for producing models.
OBJDF (Objet Digital Format)	The extension of a file that contains information about the geometry of an object <i>and</i> the materials required to print it. <i>objdf</i> files are created in Objet Studio.
OBJTF (Objet Tray Format)	The extension of a file that contains all of the information needed for a model-printing job on Objet 3D printers. An <i>objtf</i> file is used to send a print job to an Objet 3D printer.

OBJZF (Objet Z Format)	The extension of a compressed “wrapper” file containing all of the files used in an Objet Studio build tray. Using <i>objzf</i> files, a printing job can be saved as a single file, for convenient storage and transfer.
Objet™ printer	The Objet 3D printer referred to in this guide.
Printer computer	The computer inside the Connex printer that operates it. (This is sometimes referred to as the “embedded” computer.)
Printer interface	The GUI (graphical user interface) used for controlling the Connex printer.
Printer software	Software running on the computer inside the Connex printer, that controls all printer operations.
resin	The base substance from which photopolymer printing materials are made for use in Connex printers. In Objet Studio and printer-application screens, “resin” refers to cartridges of model and support materials.
SLC	A file type used with Objet software. (These files are bitmaps of individual slices of the object. For more information, see page 3-4.)
STL	A file type used with Objet software. (For more information, see page 3-4.)
Support material	Material used for supporting the structure of models during production.

Safety

Safety Features	2
Symbols and Warning Labels	3
Safety Guidelines.....	4
Printer Installation	4
Printer Operation	4
UV Radiation	4
Printer Maintenance	4
Model and Support Materials	5
UV Lamps.....	5
First Aid for Working with Printing Materials	6
Waste Disposal.....	7

Safety Features

Connex 3D printers are designed to comply with CE and FCC standards. They are equipped with the following safety features:

Cover Interlock Switch The power supplied to the UV lamp and the motion motors is turned off when the cover is opened.



WARNING: Do not defeat (override) the interlock switch. Doing so could result in serious personal injury. If the interlock switch does not function correctly, do not use the printer, and contact your service provider.

Safety Lock The cover is locked while the printer is working. The lock is released when the printer reverts to *pause* or *stop* mode.



WARNING: Do not defeat (override) the safety lock. Doing so could result in serious personal injury. If the safety lock does not function correctly, do not use the printer, and contact your service provider.

UV Screening The transparent section of the cover blocks harmful UV radiation, allowing the operator to view the model as it is being made.

Circuit Breaker The power to the printer is turned off in case of electrical overcurrent.

Note: The circuit breaker is only accessible to service personnel.

UV-Lamp Overheating Protection The power supplied to the UV lamp and the motion motors is turned off if the temperature around the lamp reaches 90 °C (194 °F). A label on the UV-lamp cover indicates if the temperature has exceeded 65 °C (150 °F).

Grounded Chassis The chassis of the printer is grounded, to prevent electrical shock.
Note: The power outlet must be properly grounded, in accordance with the local electric code, to provide this protection.

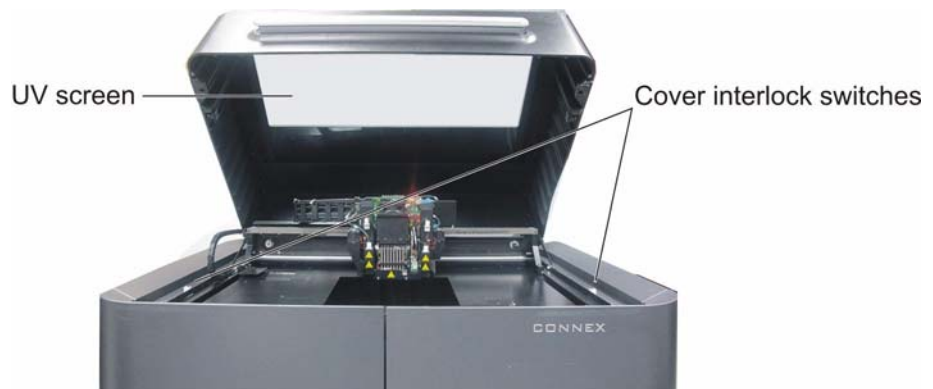







Figure 2-1: Front view of the Connex500/350 printer



If the Connex 3D printing system is not used as specified in this guide, the safety features may not provide adequate protection.

Symbols and Warning Labels

This following table lists the warning labels located on or in Connex printers.

Warning Symbol	Meaning	Location	Comments
	Hazard (general)	On the name plate on the back of the printer.	Read the instructions in this document before operating the printer.
	Hot surface	On the print-head block.	Risk of burns. Do not touch this surface after printing.
	High voltage	Near the UV lamp connectors. Near the power-supply enclosures.	Risk of electric shock.
	Ultraviolet radiation	Near the UV lamps.	Risk of injury from ultraviolet radiation.
	Moving parts	On the panel visible when you open the doors of the printing-materials compartment.	Risk of injury from moving parts.

Safety Guidelines

The following general guidelines, together with the instructions provided throughout this user guide, ensure user safety while operating and maintaining the system. **If the system is not operated as specified, the user's safety may be compromised.**

Printer Installation

- Installation and removal of the printer should only be done by qualified service personnel.
- Connect the printer (and the UPS unit) to the electric outlet using a power cord that is safety-certified.
- The electric outlet should be easily accessible, near the printer.
- Never connect the power plug to an outlet that does not have a ground (earth) wire, and never disconnect the ground. Doing so might expose the operator to serious danger from electric shock.
 - ❑ FI: Laite on liitettävä suojakoskettimilla varustettuun pistorasiaan.
 - ❑ NO: Apparaten må tilkoples jordet stikkontakt.
 - ❑ SE: Apparaten skall anslutas till jordat uttag.
- Leave a minimum of 15 centimeters between ventilation openings and walls or other objects.

Printer Operation

- The printer should only be operated by persons trained by a Stratasys customer-support representative.
- All personnel operating or maintaining the printer should know the location of first aid and emergency equipment and how to use it. **Never block access to this equipment.**
- Keep fingers and other body parts clear of the printer cover when closing it.
- Never attempt to open the printer cover while it is working.
- Never override the interlock safety switch.
- If the interlock safety switch ever fails, **do not use the printer.**
- Several parts of the printer remain extremely hot even after it has stopped operating. Avoid touching the UV lamps and the print block.

UV Radiation

- The UV lamps used in the printer emit dangerous radiation.
- If the UV lamps remain on when the printer is open, do not stare directly at the UV light. Shut down the printer and call your Stratasys service provider.

Printer Maintenance

- Service operations should be performed only by qualified personnel who have been instructed in relevant safety precautions.
- Notify co-workers and those who have access to the Connex system before beginning non-routine and hazardous work.



Report any potential dangers and safety-related accidents to your safety officer or to other appropriate authorities.

Model and Support Materials

Model and support materials are made of chemical substances. Although precautions must be taken when handling these materials directly, all model and support materials used by the Connex system are handled in sealed cartridges. Normally, operators of the printer should never be directly exposed to hazardous materials. In the unlikely event of a leak or spill, follow the instructions that are included with the printing-material cartridge used.

- Store model and support materials indoors, in a dry area with adequate ventilation, between 16-27 degrees Celsius (60-81 degrees Fahrenheit). Never expose them to flames, heat, sparks, or direct sunlight.
- Keep model and support materials away from areas where food and drink are stored, prepared and consumed.
- Uncured printing material is considered a hazardous substance, requiring certain precautions when directly handling it. To prevent skin irritation, wear **neoprene** or **nitrile gloves**. If there is any chance that model and support materials might splash into the eyes, wear safety goggles. Prolonged direct contact with printing materials can cause an allergic reaction.
- When handling UV-cured models that may not be completely cured on the surface, common latex gloves are adequate.
- To prevent respiratory irritation, ventilate areas where model and support materials are used. If the printer is not equipped with an exhaust duct, the room ventilation system should replace the air at least 20 times per hour.
- Clean up model-material and support-material spills with disposable towels or other absorbent, non-reusable material, such as sawdust or activated charcoal. Rinse the spill area with denatured or isopropyl alcohol (IPA), followed by soap and water. Dispose of the absorbent material in accordance with local regulations.
- Do not wash contaminated clothing at home; clothing should be professionally laundered.
- Dispose of contaminated shoes, belts and other leather items in accordance with any applicable regulations. Absorbed printing material may re-expose the user when these items are worn.

UV Lamps

UV lamps used by the printer to cure printing materials contain a small amount of mercury. In the unlikely event of lamp breakage, avoid inhaling mercury vapor, and ventilate the room. If the lamp ruptures (breaks) during operation, leave the room and ventilate it thoroughly (for about 30 minutes).

Use protective gloves to prevent contact with mercury and other lamp components. Carefully remove spilled mercury with a method that prevents the generation of mercury vapor, such as a syringe, packing tape or paper.

Place the broken lamp, mercury and contaminated materials in an air-tight, non-metallic container. Dispose of the container in accordance with applicable regulations.

First Aid for Working with Printing Materials

In general, try to avoid direct contact with uncured printing material. If skin or eyes come into contact with it, wash the area immediately and thoroughly with water, and follow these first-aid instructions.



The Material Safety Data Sheet (MSDS) that accompanies printing materials contains important safety information. Keep this in an accessible place where these materials are used and stored.

Contact with Skin

If uncured printing material comes in contact with skin, wash the affected area immediately and thoroughly with soap and cool water, then remove contaminated clothing. Pay particular attention to flushing the hair, ears, nose and other parts of the body that are not easily cleaned.

- Use cool water to prevent skin pores from opening, so that the liquid material does not easily penetrate the skin.
- Do not use solvents to clean skin.
- If large areas of skin have been exposed, or if prolonged contact results in blisters, seek medical attention. In any case, if irritation persists, seek medical attention.
- Avoid the accidental transfer of printing material from the hands to other areas of the body, especially to the eyes.
- If protective cream was used, do not reapply it until the skin has been completely cleansed.

Contact with Eyes

If uncured printing material comes in contact with the eyes, flush immediately with large amounts of water for 15 minutes and seek medical attention.

- Avoid sunlight, fluorescent light, and other sources of ultraviolet radiation.

Wearing contact lenses when handling liquid printing materials is not recommended. If the liquid splashes into the eyes when contact lenses are worn, immediately remove the lenses and flush the eyes with water.

- Clean and disinfect the contaminated lenses.
- Do not wear contact lenses until eye irritation disappears.

Ingestion

If printing material is swallowed, refer to the instructions included with the cartridge. **Seek medical attention immediately.**

Inhalation

Vapors from printing materials can be irritating to the respiratory system. If respiratory irritation occurs, expose the victim to fresh air immediately.

- If the victim has stopped breathing, perform artificial respiration or cardiopulmonary resuscitation.
- Seek medical attention immediately.
- Keep the victim warm but not hot.
- Never feed anything by mouth to an unconscious person.
- Oxygen should be administered by authorized personnel only.

Waste Disposal

Fully cured printed models can be disposed of as ordinary office trash. However, special care is required when handling printer waste (uncured printing material).

- Printing Materials
- When removing the waste container from the Connex printer, wear neoprene or nitrile gloves.
 - To prevent liquid waste from splashing into the eyes, wear safety goggles.
 - Liquid waste from the Connex printer is classified as hazardous industrial waste. Therefore, printing-material waste must be packaged and disposed of in a manner that prevents human contact with it and contamination of water sources.
 - Empty model-material and support-material cartridges contain residue of their contents. Some leakage of this residue may occur through the broken cartridge seal. Therefore, handle and store empty cartridges with care.
 - Do not attempt to reuse empty cartridges, and do not puncture them.
 - Dispose of used cartridges and waste containers in accordance with local regulations.
 - Discard contaminated clothing, shoes, empty containers, etc., in accordance with any applicable regulations.

- UV Lamps
- UV lamps used by the printer to cure printing materials contain a small amount of mercury, and are considered "Universal Waste." Recycle or discard used lamps in accordance with applicable regulations.

Broken lamps:

After ventilating the area, use protective gloves and carefully remove spilled mercury with a method that prevents the generation of mercury vapor, such as a syringe, packing tape or paper. Place the broken lamp, mercury and contaminated materials in an air-tight, non-metallic container. Dispose of the container in accordance with applicable regulations.

Introducing the Connex500/350 3D Printing System

Welcome to Connex	2
Work Configurations	3
Source Files.....	4
STL Files	4
SLC Files	4
Connex Workflows.....	5
Printing Materials.....	6
Storage	6
Shelf Life.....	6
Exposure to Light.....	6
Safety Considerations.....	7
Disposal	7
Work Environment.....	7
Workstation Requirements	8
Preparing Files for Use with Objet 3D Printing Systems	9
Converting CAD Files to STL Format.....	9
Converting CAD Files to SLC Format.....	9
Objet Studio Software	10

Welcome to Connex

The advanced capabilities of Connex™ 3D printing systems are made possible by technology specially developed by Stratasys for printing models simultaneously with different model materials.

With Connex printers, you can achieve the following results when printing 3D models:

- You can prepare objects for printing with two designated model materials and then print them at the same time. This enables you to assign specific mechanical and color properties to objects.
- You can print objects with combinations of basic materials (*digital materials*), enabling you to choose from a wide range of possible mechanical properties—from flexible to rigid.
- You can print parts of the same model—simultaneously—with different materials (or material combinations).
- You can print objects that have a “coating” made from a different material than the main part of the object.

Because Connex printers can be loaded with different materials, you can streamline and economize the process of producing models:

- Printing models made from different materials on the same build tray (“mixed tray”), in the same print job, eliminates the time-consuming need and expense of loading another material, flushing the system, and sending a separate job to be printed.
- You can quickly alternate printing jobs using either of the model materials loaded, or material combinations—again, without the need and expense of replacing materials.

Objet Studio enables you to split models into component parts (“shells”) so you can isolate, manipulate and print parts of a model. Then, you can assign model materials and other characteristics to the shells. However, you have ultimate control when separating models into shells by preparing *stl* files with your CAD software.



Figure 3-1: The Connex500/350 3D Printer

Work Configurations

The Connex 3D printing system can be set up as a single-station system or as a multi-station system. When connected to a local computer network, the system can serve multiple users. In such configurations, each user workstation (client) prepares files with Objet Studio software for production. A server (host), typically next to the 3D printer, acts as a job manager that sends production jobs to the printer for production.

Figure 3-2 shows the Connex printer set up in a multi-client configuration.

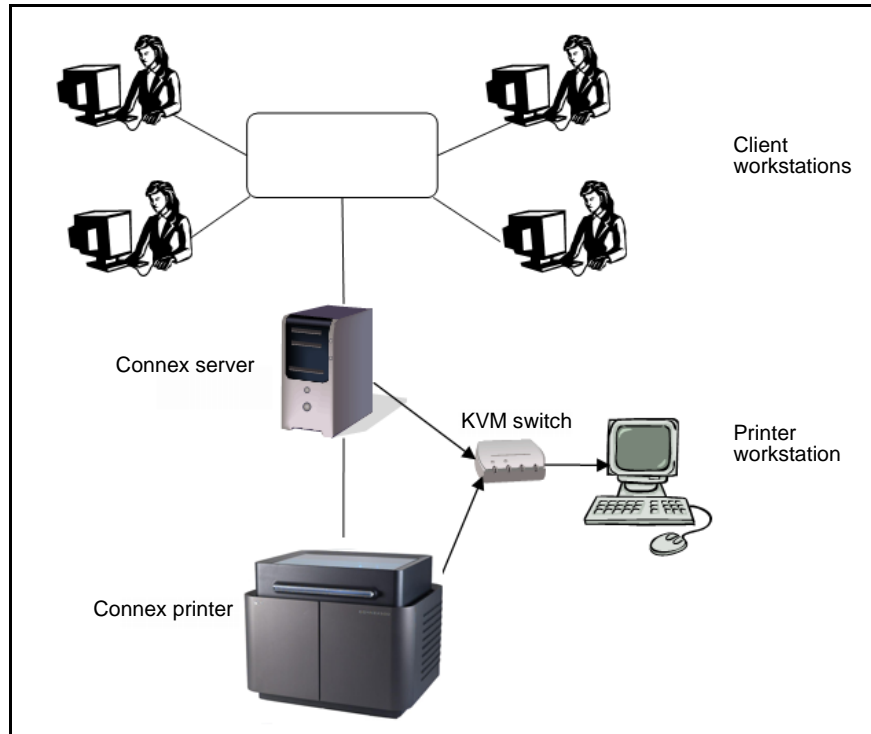

Figure 3-2: Multi-client network configuration

When installing Objet Studio, you choose whether to install it as a client station or as a master station (server or standalone station).

Objet Studio arranges the jobs it receives according to their priorities, model-material type, and other factors. In multi-workstation configurations, the operator of the server—typically the production administrator—has total control over the jobs sent to the 3D printer, and can prioritize and delete jobs, review job history and reprint a job, and so on.

Source Files

Objet 3D printing systems produce three-dimensional models designed with most 3D CAD tools and with other job-specific 3D applications.

Connex systems accept:

- STL Files
- SLC Files

Connex systems feature the capability of producing different types of model files simultaneously.

STL Files

STL is short for *Standard Triangulation Language*. This language views any object as a collection of surfaces, and describes each surface of the object as a collection of triangles.

For example, a square can be described as two triangles; a cube (six squares) as 12 triangles. Curved surfaces need more triangles to describe them. The higher the tolerance (for smooth surfaces), the more triangles are needed. The result is that high-quality object descriptions mean very heavy files.

Most CAD software can export STL files. The Connex system utilizes these files for building models (rapid prototyping), and also for directly making molds for mass-producing items.

STL files can be ASCII (text) files or binary files. The content of the ASCII file begins with “solid” and ends with “end-solid” (both lower case). Between these keywords is a list of the triangles that describes the faces of the solid model. Each triangle defines a single normal vector directed away from the solid’s surface, followed by its X-Y-Z coordinates. These are expressed as Cartesian coordinates and are floating-point values. The coordinates of all triangles should be positive and should fall within the volume of the model.



SLC Files

SLC is short for *Stereo-Lithography Contour*. SLC files describe two-dimensional contours of the three-dimensional models. These contour lines are polylines.

SLC files are ASCII (text) files that save models as a series of slices. This means that models based on SLC files cannot be orientated; only their scale (size) and position on the build tray can be controlled. For this reason, the model’s orientation must be suitable for production before it is saved as an SLC file. Because of the nature of SLC files, the appearance of models in Objet Studio may be different than the solid-object images displayed from STL files.

Connex Workflows

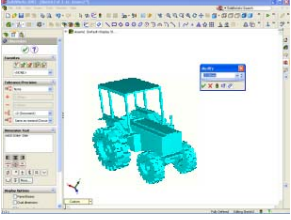
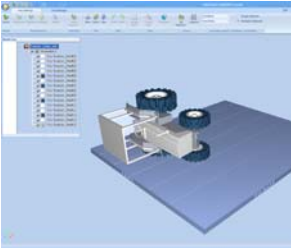
With Connex 3D printing systems, you have great flexibility in preparing model files and printing them. Below are the major workflows you can use. Detailed instructions for implementing the listed tasks are in chapter 5 (“Using Objet Studio”).

Stage	Workflow A	Workflow B	Workflow C
<p>CAD program</p> 	<ul style="list-style-type: none"> • Design a 3D object. • Save it as a single <i>stl</i> file. 	<ul style="list-style-type: none"> • Design a 3D object. • Save it as an assembly of <i>stl</i> files. 	<ul style="list-style-type: none"> • Design a 3D object.
<p>Objet Studio</p> 	<ul style="list-style-type: none"> • Open (<i>Insert</i>) the <i>stl</i> file. • Separate the object into its components (“shells”). • Assign materials to the components. 	<ul style="list-style-type: none"> • Open (<i>Insert</i>) the <i>stl</i> files as an <i>assembly</i>. • Assign materials to the assembly’s components. 	<ul style="list-style-type: none"> • Open (<i>Insert</i>) an <i>objdf</i> file. (<i>objdf</i> files contain model-material information.)
	<ul style="list-style-type: none"> • Save the object as an <i>objdf</i> file (optional). 		
<p>Connex Printer</p> 	<p style="text-align: center;"><i>Models are produced in the printer.</i></p>		
	<ul style="list-style-type: none"> • Remove the support material from the models. 		
<p>Finished model</p> 	<p style="text-align: center;"><i>Finished model.</i></p>		

Connex workflows, from design to finished models

Printing Materials

Connex printers produce models by jetting thin layers of printing materials on the build tray, until the complete model is formed. Two types of material are used in this process:

- *Model* material— which makes up the finished model
- *Support* material— which fills gaps and spaces in the model during printing, and is removed after printing



For up-to-date information about PolyJet printing materials and their properties, go to <http://www.stratasys.com/materials/polyjet>.

Storage

Materials used for printing models with Connex printers are made of resins, which are composed of reactive monomers and oligomers. Although printing materials are supplied in sealed, UV-proof cartridges, care must be taken when storing and handling them. Follow these guidelines to protect operators and the environment, and to ensure optimum results.

- To ensure product stability, do not allow these materials to come into contact with metal. Plastics made from monomer-soluble substances (such as polystyrene or polyvinyl chloride) are not suitable for storing PolyJet printing materials.
- When not in use, keep material cartridges tightly sealed to prevent contamination, the effects of exposure to UV radiation, and accidental spillage.
- Store material cartridges indoors, in a dry area with adequate ventilation, between 16–27 degrees Celsius (60–81 degrees Fahrenheit). If exposed to heat or flames, cartridges might burst or ignite.
- Signs of premature polymerization in material cartridges include bulging, leaking, the emission of heat, and unusual odor. Exposure to heat can cause resin to gel in the cartridge.
- Make sure that material cartridges are stored in accordance with all local regulations and other applicable requirements.

Shelf Life

Materials used for producing models have a limited shelf life. The expiry date on the label is valid when properly stored in an undamaged, unopened cartridge. Always rotate your stock, so that the cartridge with the earliest date is used first.

Exposure to Light

If printing materials are not in their sealed cartridges, make sure to shield them from sunlight and other sources of UV radiation, such as fluorescent and mercury-vapor lights. Exposure to UV radiation causes an increase in viscosity and, eventually, solidification.

Safety Considerations

Before being cured, resins are hazardous materials. To prevent possible health hazards, follow these precautions regarding printing materials:

- Do not expose to flames, heat or sparks.
- Prevent contact with skin and eyes.
- Ventilate areas where they are handled.
- Keep them separate from food and drink.

Cured plastic parts, however, are safe. They can be handled and stored without precautions.



You can find more safety information about resins in “Safety Guidelines” on page 2-4, and “First Aid for Working with Printing Materials” on page 2-6.

Disposal

Dispose of cartridges of model and support material in accordance with all applicable laws and regulations. If necessary, the cartridges can be disassembled for recycling.

Work Environment

Extreme heat and humidity conditions can adversely affect the operation of the Connex 3D printer. Use ventilation or air-conditioning systems, if necessary, to keep the work area within the following ranges:

- 18°–25° C (64°–77° F)
- 30%–70% relative humidity

Workstation Requirements

The table below lists the requirements for computer components on workstations running Objet Studio.

Important: Make sure that the server workstation is set up with Administrator privileges.

	Requirement
Computer Type	Server workstation: Standard desktop PC ¹
Processor	Intel® Core™ i3 or better
Operating System	Windows® 7 or Windows® 8, 64-bit ²
RAM	8 GB or more ²
Graphics Card ³	Open GL® Memory: 1 GB; 2 GB recommended for dental applications
	For server workstation: VGA connector ⁴
Optical Drive	CD/DVD ROM
Hard-Disk Drive	80 GB or larger (minimum free space: 40 GB)
Network Card	LAN TCP/IP (2 for server workstation; 1 for client workstation)
Mouse/Keyboard Connection	Server workstation: USB ¹
Monitor Cable	VGA connector ¹

1. For systems using a KVM switchbox to control both the built-in printer computer and the server workstation with same keyboard-monitor-mouse set: All-in-one computer, wireless mouse and wireless keyboard cannot be used.
2. A 64-bit operating system is recommended, to utilize 8 GB of memory. Objet Studio running on a 32-bit application can utilize only 4 GB of memory.
3. The following graphics cards were tested in Stratasys labs:
 - NVIDIA® Quadro® Family—FX570, FX1700
 - NVIDIA® GeForce® Family—6200 TurboCache™, 7300 GT, GTX 285
 - Intel® Express Chipset—82915G/GV, 82910GL, Q965, Q963, Q35, Q45, Q43, 82852, 82855
 - ATI Radeon™ HD 5670, HD 5970
 - AMD Radeon™ E6760
4. For systems using a KVM switchbox. If the server workstation has a DVI video connector, a VGA adapter is needed.

Preparing Files for Use with Objet 3D Printing Systems

Before using files with Connex 3D printing systems, you need to convert them in your CAD program to a file format supported by Objet Studio. (For an explanation of these file formats, see “Source Files” on page 4.)

Converting CAD Files to STL Format

This procedure may vary slightly, depending on the CAD software used, but the following instructions generally apply.

To convert a file to STL format (in a CAD program):

1. From the File menu, select Save As.
2. In the *Save As* dialog box, open the *Save As Type* drop-down list and select *.STL.
3. Click Options and set the following parameters:
 - Total Quality—approximately 0.01 mm (deviation tolerance / linear-dimension tolerance)
 - Detail Quality—approximately 5° (angle tolerance)

Note: Lowering these values produces more accurate models, but results in larger files and longer loading and processing times. For this reason, it is generally not recommended that you use lower values.
4. In the file format option, choose *binary* or *ASCII*. (Both binary and ASCII formats can be used in Objet Studio. However, binary files are smaller, so this option is recommended.)
5. Click OK or Save.

After converting the model files, it is recommended that you check them for defects in an STL-repair application (such as Magics™, by Materialise®) before opening them in Objet Studio and producing the model.



For more information, search for “CAD to STL” on www.stratasys.com.

Converting CAD Files to SLC Format

When converting files to SLC format, it is recommended that you set a layer thickness of 15 microns (0.015 mm). Since SLC files cannot be orientated in Objet Studio, it is important that models are properly orientated before being saved as SLC files. Considerations for suitable model orientation are explained in “Model Orientation” on page 5-28.

Objet Studio Software

Objet Studio software for the Connex 3D printing system consists of two main screens:

- Tray Settings / Model Settings
- Job Manager

Tray Settings / Model Settings

In the *Tray Settings* and *Model Settings* screens, you prepare source files for production in Connex 3D printers. Objet Studio offers you a wide variety of file-preparation options, but always consists of the following basic procedure:

1. Inserting one or more objects on the *build tray*
2. Positioning the object(s) on the tray
3. Configuring object and tray parameters
4. Saving the tray configuration as an *objtf* (Objet Tray Format) file
5. Sending the *objtf* file to the Connex 3D printer for production

Using Objet Studio to perform these tasks is described in detail in chapter 5, “Using Objet Studio.”

Job Manager

The *Job Manager* screen is different for client workstations and for the computer connected directly to the Connex 3D printer.

- In Objet Studio installed on the directly-connected computer (server), the *Job Manager* screen displays the queue and status for all jobs sent to the 3D printer by the server itself and by all client computers on the network. All jobs displayed can be edited and manipulated.
- In Objet Studio installed on client computers, the Job Manager screen displays the queue and status only for jobs sent to a 3D printer server from that computer. Only these jobs can be edited and manipulated from the client computer.



Client computers can be connected, via the local network, to different Objet 3D printers, but only to one at a time. The *Job Manager* screen displays the status of the 3D printer to which the client is currently connected.

4

Installing Objet Software

How to Install Software for the Connex 3D Printing System 2

How to Install Software for the Connex 3D Printing System

The Objet Studio setup wizard guides you when installing this software. Objet Studio is installed on the printer-server (“host”) computer, but it can also be installed on remote, “client” computers and on computers used to prepare files for printing models, or for training and demonstration purposes. During installation, you choose to install either the printer-server (“host”) application or the client application.

To install Objet software:

1. Insert the Objet Studio CD into the disk drive.
2. Right-click the Start button and select Explore (or use any other method for displaying files on the computer).
3. Open the CD-drive folder and select Setup.
4. If you are installing an Objet Studio upgrade, make sure that your printer is compatible with it by checking the list displayed.

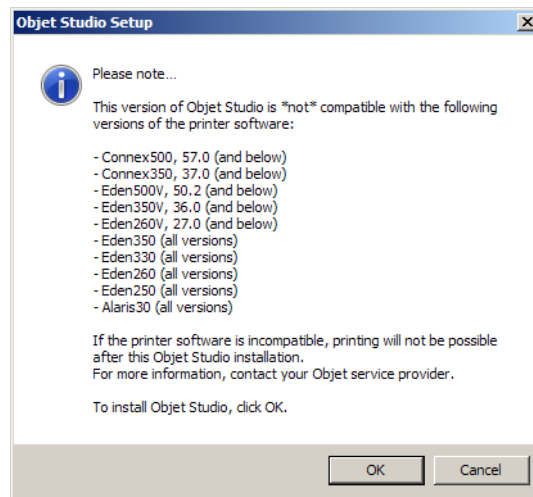

Figure 4-1:Objet Studio compatibility check

5. To install Objet Studio, you must agree to the license agreement. After reading its terms, click Yes to continue, or No to close the wizard.

If you click **Yes**, the following screen should appear.

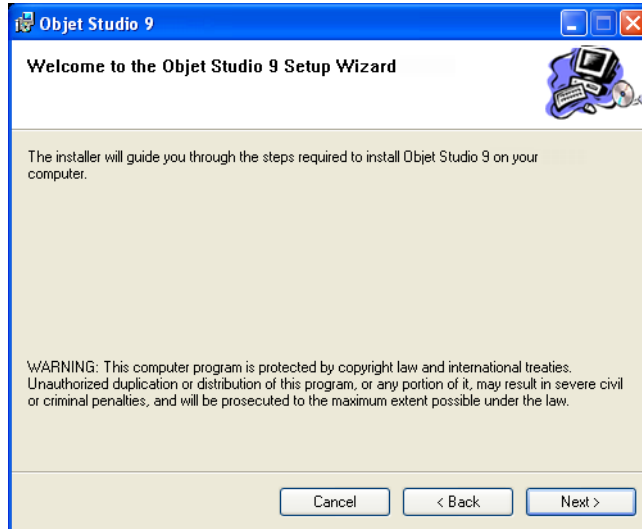

Figure 4-2: Objet Studio installation wizard—*Welcome* screen

6. Click **Next** to begin installation.
7. In the *Select Features* screen, select the required installation option.
Select **Objet Studio for a server computer...**
 - if you are installing Objet Studio on the server (“host”) computer—the computer directly connected to an Connex printer.
 - if you are installing Objet Studio on a standalone (off-line) computer.

Select **Objet Studio for client workstations** if you are installing Objet Studio on a “client” workstation—a remote computer that prepares print jobs and then sends them to a server computer.

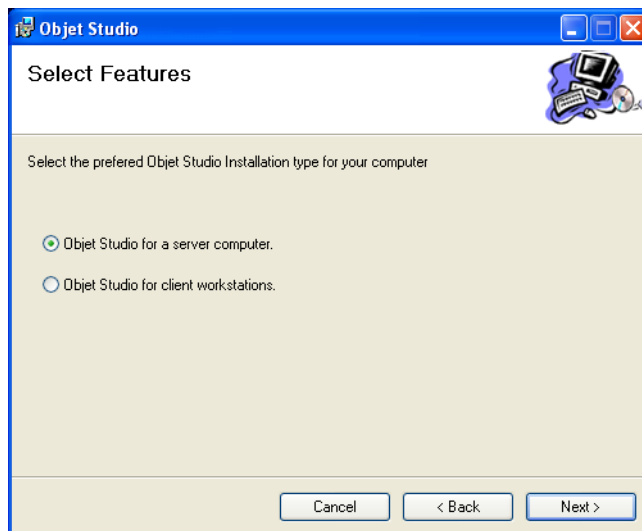

Figure 4-3: Objet Studio configuration selection

8. In the *Select Installation Folder* screen, verify the destination folder and click Next.



It is recommended that you do not change the default destination folder. Click **Disk Space** to check the space in the destination folder.

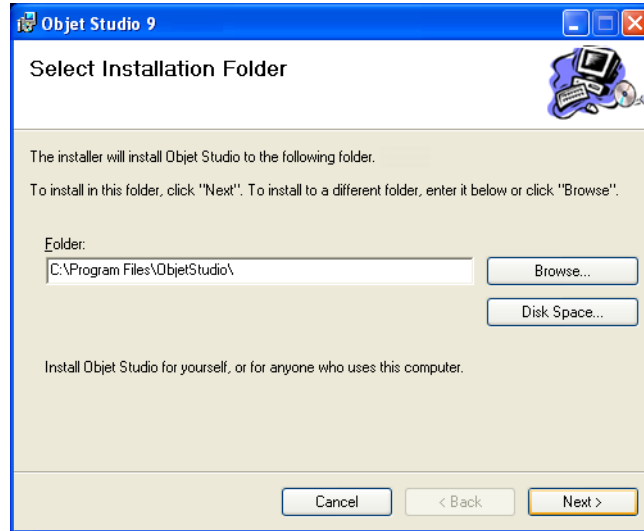

Figure 4-4: Objet Studio installation-folder selection

9. In the *Confirm Installation* screen, click Next to begin installation.
10. In the *Select Printer Type* screen, select the Objet 3D printer used for producing models and click Next.

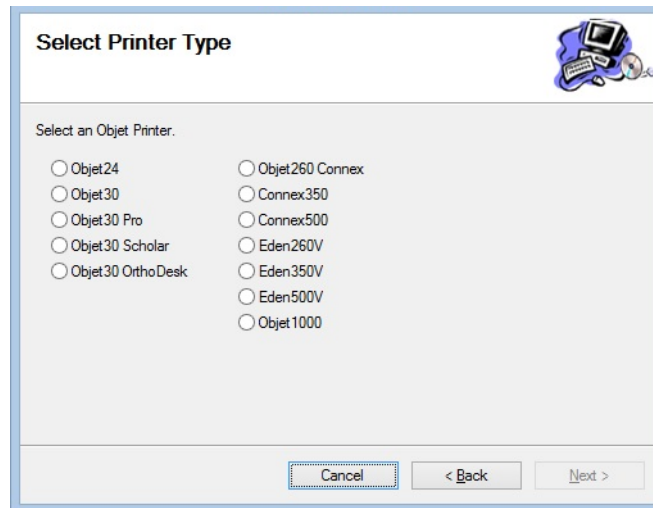

Figure 4-5: Printer selection

Installation begins and a progress bar appears, showing the progress of the installation process.

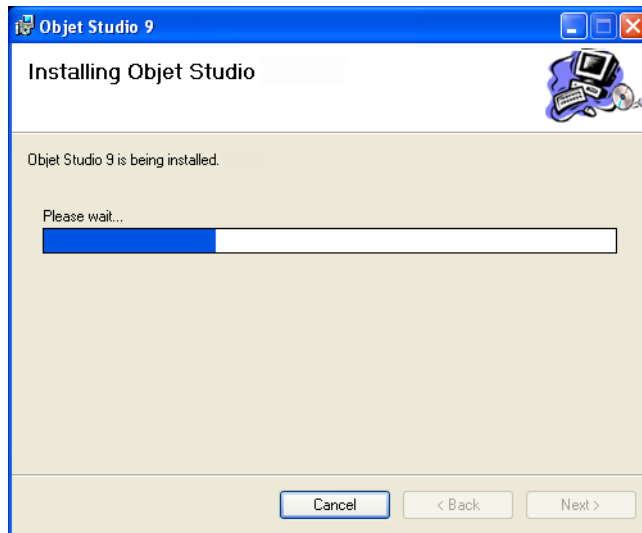

Figure 4-6: Installation progress bar

When the Objet program installation is complete, the final InstallShield wizard screen appears.

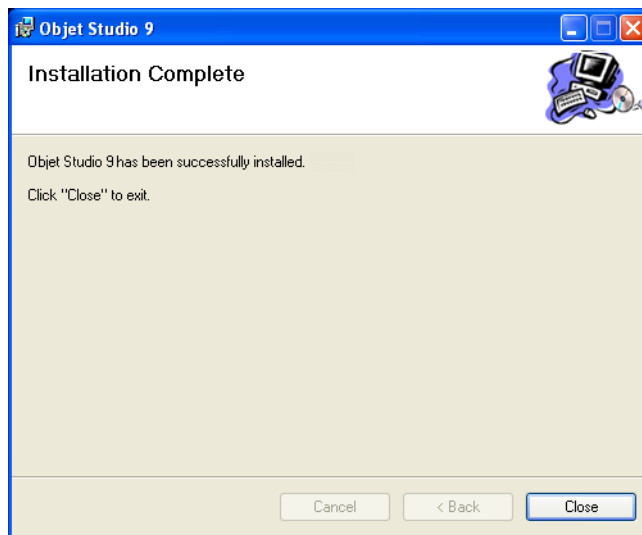

Figure 4-7: Final installation screen

11. Restart the computer to complete the software installation.

Note: If you installed the software from a CD or DVD, make sure to remove it from the disk drive before restarting the computer.

The installation process ends when the appropriate icon(s) appear on the computer desktop:

- Objet Studio
- Stop Job Manager (for servers and standalone stations)

How to Uninstall Objet Studio

If there is ever a need to uninstall the Objet Studio software, do **not** attempt to do so from the Windows Control Panel. (This does not completely remove all software components.) Instead—

- From the *Start* menu, select All Programs > Objet Studio > Uninstall Objet Studio.

Using Objet Studio

Launching Objet Studio.....	3
Windows® 7 Security Warning.....	3
Objet Studio Interface.....	4
Ribbon Commands.....	6
Objet Studio Commands Menu.....	8
Model Tree Pane.....	8
Preparing Models for Production.....	9
OBJDF Files: Overview.....	9
Model Files.....	9
Placing Objects on the Build Tray.....	10
Opening Objet Tray Files.....	14
Quick-Access Model Commands.....	16
Copying and Pasting Objects.....	17
Selecting Objects.....	18
Splitting Objects into Components.....	19
Model-Material Settings.....	20
Changing the Model Material.....	21
Digital Materials.....	22
Assigning a Model Material to Objects.....	23
Surface Finish.....	24
Coating Objects.....	24
Assigning Properties to Hidden Objects.....	25
Positioning Objects on the Build Tray.....	26
Automatic Orientation.....	26
Automatic Placement.....	27
Manual Positioning.....	27
Model Orientation.....	28
Manipulating Objects on the Build Tray.....	29
Positioning Objects on the Z-Axis.....	29
Valid Object Placement.....	30
Using a Grid to Position Objects.....	31
Measurement Units.....	32
Setting Model Dimensions.....	33
Repositioning Objects.....	33
Changing an Object's Orientation.....	35
Grouping and Ungrouping Objects.....	36
Freezing Model Orientation.....	38

Display Options.....	39
Viewing Objects.....	39
Screen Layout	41
Tray Perspective	42
Setting Object Colors	43
Loading Large Files	44
Large File Manipulation.....	44
Zoom Options.....	46
Handling Completed Trays	47
Tray Validation	47
Production Estimates.....	48
Printing Modes.....	49
E-mailing Objet Digital Files	50
Printing the Tray File	50
Applying Additional Objet Studio Features	53
Dividing Objects.....	53
Choosing the Support Strength.....	54
“Hollow” – Filling Models with Support Material	55
Displaying the Cross Section of Objects	56
Saving the Screen Display as an Image File	57
Exporting and Importing Objet Build Trays	58
Customizing Objet Studio.....	59
Creating a Quick Access Toolbar	59
Hiding the Ribbon.....	60
Display Colors	61
Keyboard Shortcuts	62
Setting User Preferences.....	63
Professional Mode Features.....	64
Default Settings	65
OpenGL Driver Configuration.....	66
Getting Additional Objet Studio Assistance	68
Objet Studio Version, Material Module and Licensed Features.	68
Monitoring and Managing Print Jobs	70
Job Manager Screen	70
Setting the Printer Connection	72
Off-line Mode.....	73
Setting the Remote Printer Connection (Client Mode).....	75
Job Manager Commands	75
Configuring User Alerts.....	78
Printing the Tray.....	79
Additional Server Features.....	79

Launching Objet Studio

After you install Objet Studio, a launch icon  appears on the Windows desktop. Open the application by double-clicking this icon, or by selecting Objet Studio from the Start menu.

Windows[®] 7 Security Warning

Depending on the User Account Control settings in Windows[®] 7, you might see the following warning when opening Objet Studio.

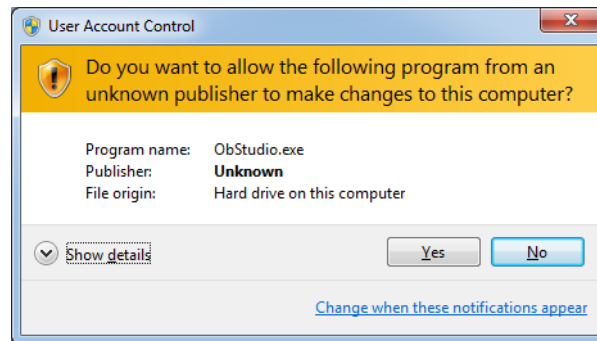

Figure 5-1: Security Warning

If you click Yes, Objet Studio opens. However, this warning message will appear each time you open the program, unless you change the User Account Control settings.

To prevent the warning message from appearing again:

1. Click the link at the bottom of the security warning dialog box (Change when these notifications appear).
2. In the User Account Control Settings screen, move the slider to “Never notify.”

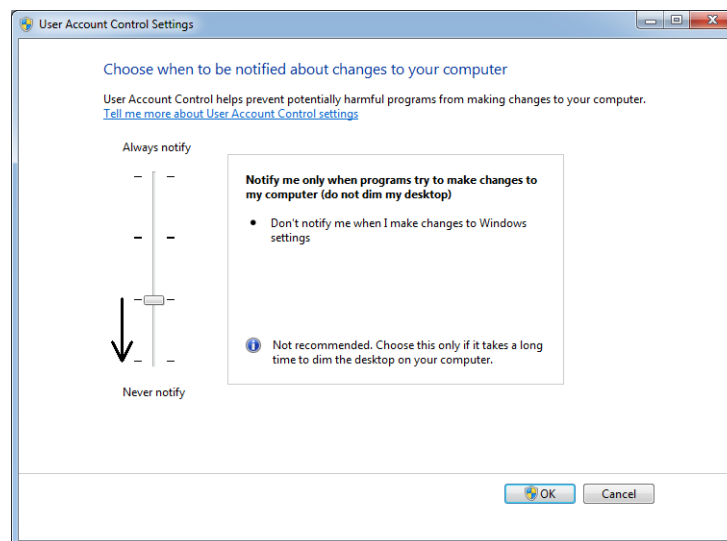

Figure 5-2: Changing the User Account Control settings

3. Click OK.

4. In the following dialog box, click Yes.

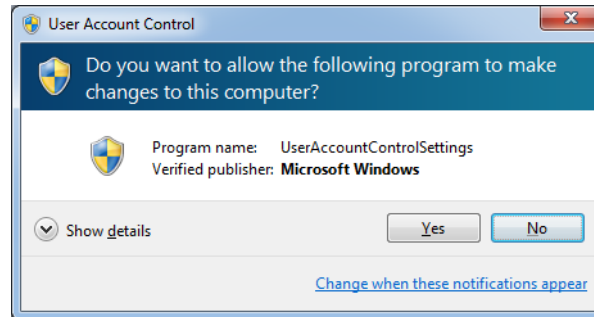

Figure 5-3: Confirming the change in the User Account Control settings

Objet Studio Interface

When Objet Studio opens, the *Tray Settings* screen appears, showing an empty build tray.

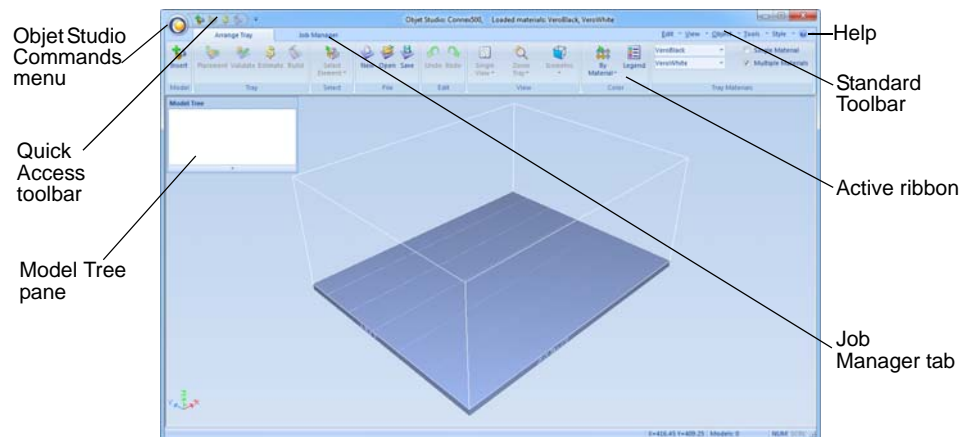

Figure 5-4: Objet Studio opening screen

The Objet Studio interface consists of two main screens:

- **Tray Settings**—for arranging models and preparing them for printing.
- **Job Manager**—for monitoring and managing print jobs.

This screen is described in “Monitoring and Managing Print Jobs” on page 70.

Each screen is controlled by menus and icons on its own ribbon. An additional ribbon, *Model Settings*, displays controls for configuring and manipulating selected models.

Objet Studio anticipates your workflow by displaying and enabling the options relevant to your current task. For example, when you first open Objet Studio, the *Model Settings* ribbon is disabled until you place a model on the build tray. Similarly, options available from the standard toolbar menus are enabled or disabled to match the current workflow.

The ribbon, colors used, and several other interface features can be customized. How to change the appearance of the interface is explained in “Customizing Objet Studio” on page 59.



Instructions for using the commands for preparing models for production and sending jobs to the printer, appear later in this chapter.

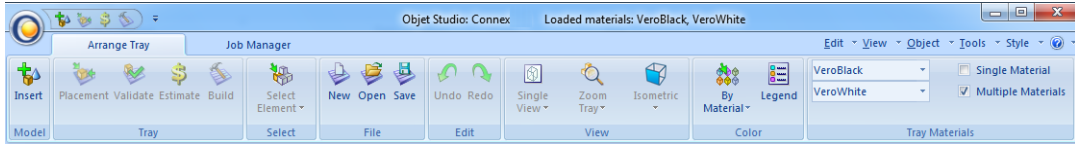

Figure 5-5: Tray Settings ribbon

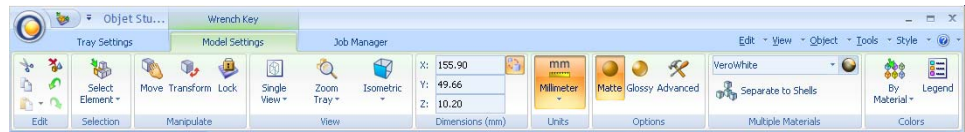
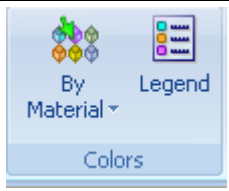



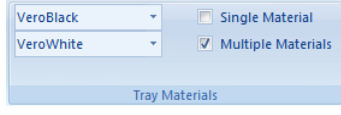

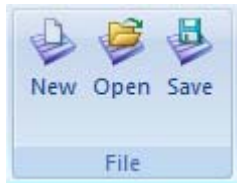

Figure 5-6: Model Settings ribbon

Ribbon
Commands

The following table lists the *Tray Settings* and *Model Settings* ribbon command groups, and shows when they are enabled, and where they appear.

Group	Purpose	When enabled	Tray Settings Ribbon	Model Settings Ribbon
 The image shows the 'Colors' ribbon group in the software interface. It includes a 'By Material' dropdown menu, a 'Legend' icon, and a 'Colors' button at the bottom.	Setting display colors.	Always.	<input checked="" type="checkbox"/>	<input checked="" type="checkbox"/>
 The image shows the 'View' ribbon group. It contains 'Single View' and 'Zoom Tray' dropdown menus, and a 'View' button at the bottom.	Selecting perspective and zoom level.	Models are on the build tray.	<input checked="" type="checkbox"/>	<input checked="" type="checkbox"/>
 The image shows the 'Select Element' ribbon group. It features a 'Select Element' dropdown menu and a 'Action' button below it.	Choose to select a plane, elements, or element groups (assemblies).	Models are on the build tray.	<input checked="" type="checkbox"/>	<input checked="" type="checkbox"/>
 The image shows the 'Isometric' ribbon group. It has an 'Isometric' dropdown menu and a grid of icons representing different perspective views.	Change the perspective of the active pane.	Models are on the build tray.	<input checked="" type="checkbox"/>	<input checked="" type="checkbox"/>
 The image shows the 'Tray Materials' ribbon group. It includes two dropdown menus labeled 'VeroBlack' and 'VeroWhite', and two checkboxes for 'Single Material' and 'Multiple Materials'. A 'Tray Materials' button is at the bottom.	Assigning printing material(s).	<ul style="list-style-type: none"> • Build tray is empty. • Models are not selected. 	<input checked="" type="checkbox"/>	
 The image shows the 'Edit' ribbon group. It contains 'Undo' and 'Redo' buttons with circular arrows, and an 'Edit' button at the bottom.	Undoing or redoing actions.	After an action or object selection.	<input checked="" type="checkbox"/>	<input checked="" type="checkbox"/>
 The image shows the 'File' ribbon group. It features 'New', 'Open', and 'Save' buttons, and a 'File' button at the bottom.	Opening and saving files.	Models are not selected.	<input checked="" type="checkbox"/>	

Group	Purpose	When enabled	Tray Settings Ribbon	Model Settings Ribbon
	Placing model files on the build tray.	Always.	<input checked="" type="checkbox"/>	
	Pre-build/build commands.	Models are on the build tray.	<input checked="" type="checkbox"/>	
	Setting model dimensions.	A model is selected.		<input checked="" type="checkbox"/>
	Cutting, copying, pasting and deleting models.	A model is selected.		<input checked="" type="checkbox"/>
	Moving, rotating and resizing models.	A model is selected.		<input checked="" type="checkbox"/>
	<ul style="list-style-type: none"> Assigning a material to a model or shell. Separating a model into shells. 	A model is selected.		<input checked="" type="checkbox"/>
	Assigning model finish and setting support strength/“hollow.”	A model is selected.		<input checked="" type="checkbox"/>
	Setting a model’s unit of measure (millimeters or inches).	A model is selected.		<input checked="" type="checkbox"/>



To quickly identify an icon, move the cursor over it to display a tooltip. The “Undo” and “Redo” tooltips change to reflect your last Objet Studio action.



After activating some of the ribbon commands (by clicking them), they remain active until you click another button or until you press the Escape key.

Objet Studio Commands Menu

Clicking the  icon in the upper-left corner opens the Objet Studio Commands menu. This menu displays basic application commands and options.

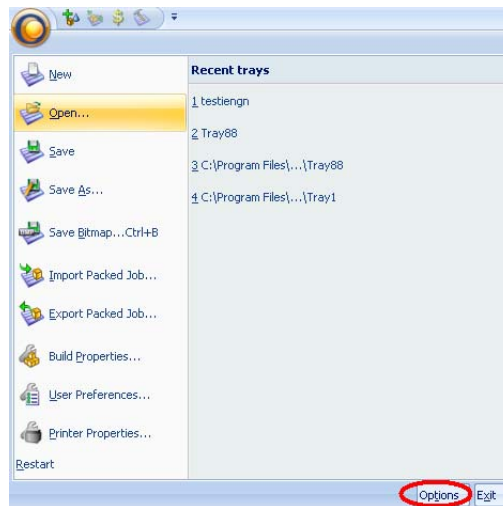

Figure 5-7: Objet Studio Commands menu

The *Options* button opens a dialog box for customizing Objet Studio.

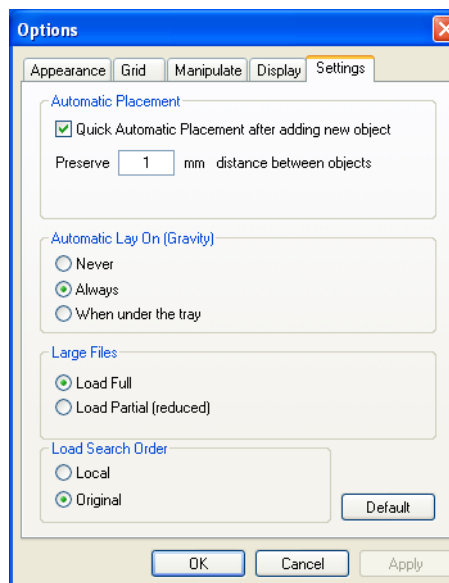

Figure 5-8: *Options* dialog box

Model Tree Pane

The *Model Tree* pane lists the objects placed on the build tray in a parent-child hierarchy. By default, the pane “floats” — that is, you can move it to another position on the screen and resize it. Alternatively, you can fix its position at the left of the application window, and even hide it.

Preparing Models for Production

Model preparation involves the following basic steps:

1. Place objects or assemblies on the build tray.
2. If necessary, manipulate the object's orientation and position.
3. Select the materials and model finish.

Just as Connex printers can produce different models on the build tray using different materials, you can produce components of a model with different materials. To do this, each part of the model must be a separate *stl* file. If the model's component parts were not saved in the CAD software as separate *stl* files, you can use Objet Studio to separate the model into component parts. (This is described in "Splitting Objects into Components" on page 19 and in "Dividing Objects" on page 53.)

OBJDF Files: Overview

An *objdf* file describes both the geometry of a single object and the materials, and finish required to print it. The *objdf* file can represent an object that is a single *stl* file, or an object assembled from component *stl* files.

Objet Studio enables you to split an *stl* file representing a complex object into an assembly of component *stl* files, and save the assembly as an *objdf* file. Each part (*stl* file) described by the *objdf* file can have its own model-material characteristic, so that the Connex printer produces the component parts from specific materials.

Another use for *objdf* files is for saving a group of separate objects on the build tray as one unit, together with their relative positions and materials. This is especially useful for producing models in the future with the same materials. In fact, when you save *objdf* files, you specify materials for printing models without regard to the material cartridges loaded in the printer. The same object can later be placed on build trays for printing. Each time you send a build tray to the printer, you decide whether to allow printing with substitute materials or only with the materials specified.

The Connex version of Objet Studio enables you to display, manipulate and print component parts of a model assembly that was saved as an *objdf* file, since each component is a separate *stl* file. This can be useful for printing only specific parts of a model.

Further explanations of *objdf* files and assemblies, and their features, appear throughout this chapter.

Model Files

To produce models, you open one or more model files in Objet Studio and position objects on the build tray. You can place objects on the build tray in several ways:

- by inserting individual *stl* or *slc* files (or an assembly of *stl* files).
- by inserting an *objdf* file (an assembly).
- by pasting objects that you copied to the Windows clipboard.

Placing Objects on the Build Tray

To place an object on the build tray:

1. Open the *Insert* dialog box—
 - From the *Object* menu, select *Insert*.
 or—
 - On the *Tray Settings* ribbon, click  *Insert*.
 or—
 - Right-click on the build tray, and select *Insert* from the context menu.

The *Insert* dialog box appears.

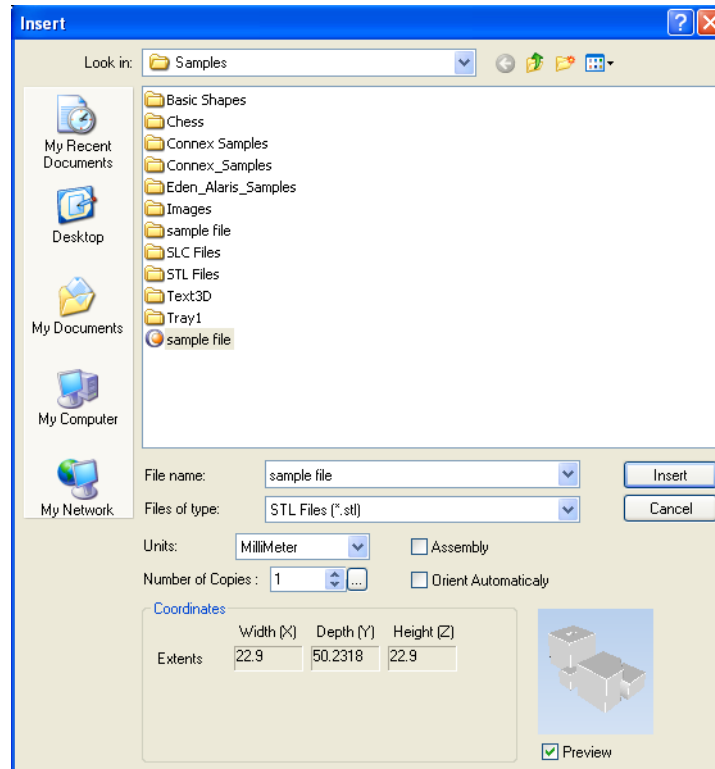

Figure 5-9: *Insert* dialog box

2. In the *Look in* field, display the appropriate folder.
3. In the *Files of type* field, select the file type to display.
4. Select the desired file, and make sure that it appears in the *File name* field.

If the *Preview* check box is selected, the object is displayed in the dialog box, as shown in figure 5-9.

You can open several *stl* files to place several models on the build tray. If you select multiple *stl* files that make up an assembly, you can select all or some of the parts. To print the entire model, select all of an assembly's component *stl* files, and select the *Assembly* check box. This positions the parts as a complete, integrated model instead of as independent parts. The effects of selecting the *Assembly* check box—in both the model tree and the build tray display—are shown in the following figures.

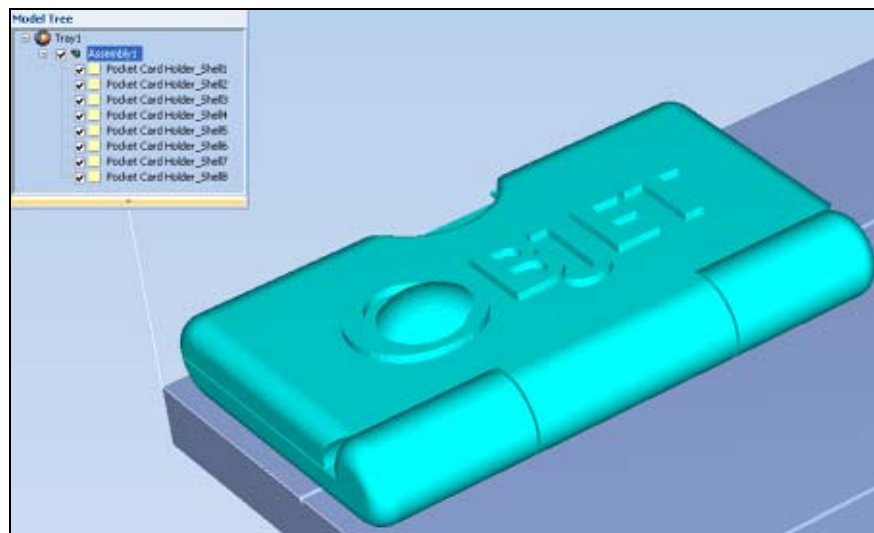

Figure 5-10: *Assembly* check box selected—*stl* files are placed as an *assembly*

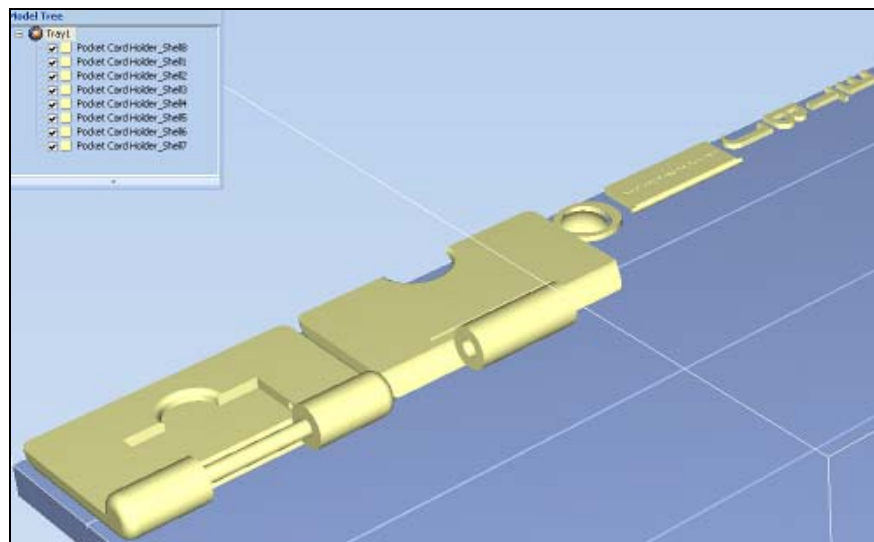

Figure 5-11: *Assembly* check box not selected—*stl* files are placed as *parts*

The *Model Settings* ribbon is displayed when objects are placed on the build tray.

5. Select any of the following options, as required:
 - **Units**—*Millimeters* or *inches* for the object's units of measure.
The 3D file contains the object's proportions, but not its units of measure. Therefore, make sure to correctly select either millimeters or inches when inserting an object. Otherwise, the size of the object on the build tray will be either much too large or much too small. To change the measurement units of objects already placed on the tray, see "Measurement Units" on page 32.
 - **Number of copies**—How many copies of this object to place on the build tray.
 - **Orient Automatically**—Automatically orient objects on the build tray for efficient model building.
 - **Assembly**—Mark this check box if you selected multiple *stl* files that are part of an assembly.

Note: The Extents values displayed in the *Coordinates* section of the *Insert* dialog box, represent the maximum dimensions of the object on each axis. These dimensions correspond to the virtual “bounding box” surrounding the object (see figure 5-52 on page 40).

6. Click Insert.

Objet Studio places the object on the build tray, and in the model tree.

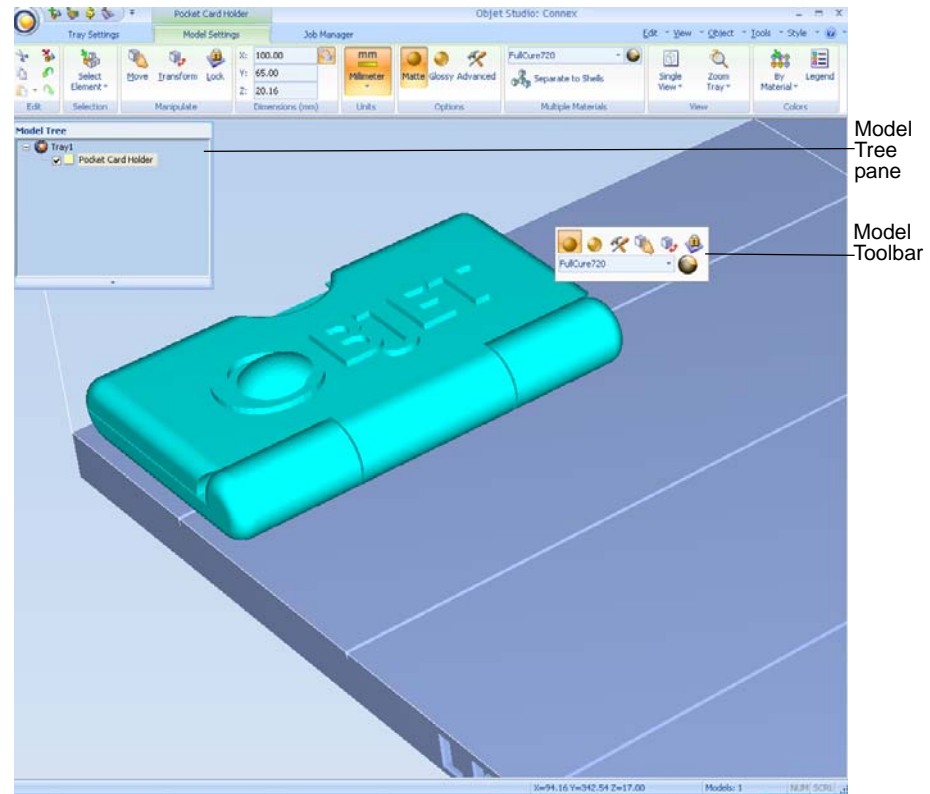

Figure 5-12: Default screen layout

The *Model Settings* ribbon is displayed when objects are placed on the build tray.

If the object is over a certain size, the *Loading Placed Elements* dialog box appears.

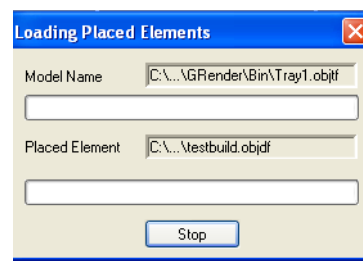

Figure 5-13: *Loading Placed Elements* dialog box



You can speed up the opening of large files by changing the *Large Files* settings—see “Loading Large Files” on page 44).

Opening *objdf* Files

Before placing *objdf* files on the build tray, Objet Studio must extract the component *stl* files together with information about their relative position and model materials. To do this, Objet Studio creates a folder with the same name as the *objdf* file, in the same location.



If you are opening an *objdf* file, the *Insert* dialog box also includes a *Materials* field that shows the object's printing material assignment (see below).

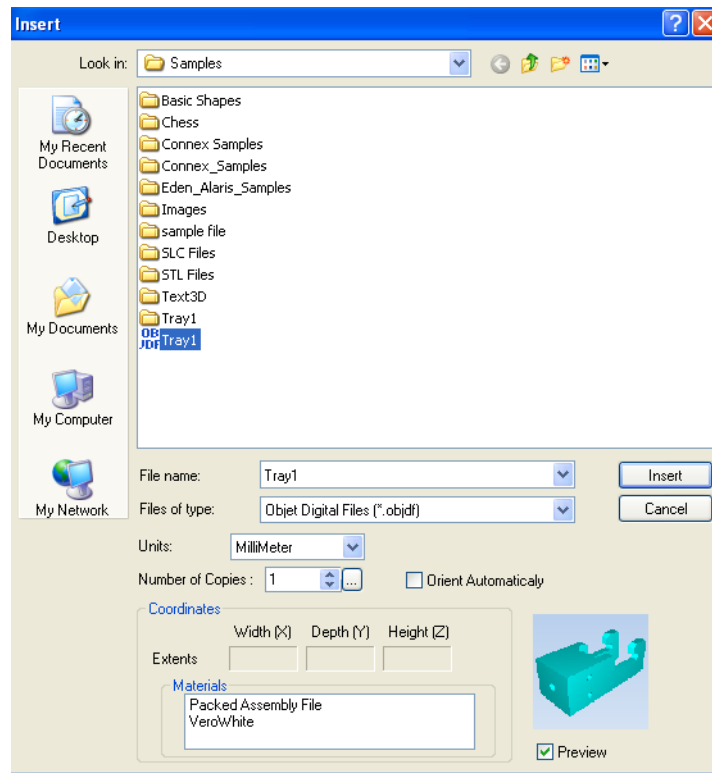

Figure 5-14: *Insert* dialog box (*objdf* file)



A warning message appears if a part is defined with materials not supported by your system, or if an object already on the build tray uses different materials. (If this happens, see “Model-Material Settings” on page 20 for printing options.)

Opening Objet Tray Files

You can open trays that were saved as *objtf* files. This is useful, for example, if you saved a tray after preparing it for printing, and now you want to make changes before printing it.

To place an object saved as an Objet Tray File (*objtf*) file on the build tray:

1. From the *File* group, click  **Open**.

OR —

From the Objet Studio Commands menu , select **Open**.

The *Open* dialog box is displayed.

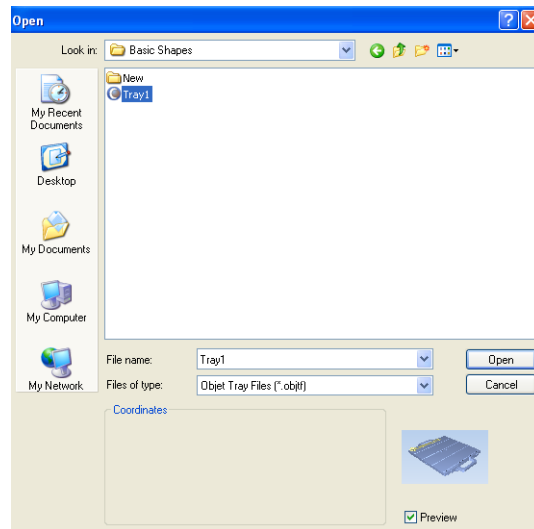

Figure 5-15: Objet Tray File *Open* dialog box

2. Select the desired file, and make sure that it appears in the *File name* field.

If the *Preview* check box is selected, the object is displayed.

3. Click **Open**.

Objet Studio opens the tray file.



The *objtf* file is actually a file containing instructions for printing—which *stl* files to print and their position on the build tray. Because the *objtf* file references the *stl* files used, they must remain in the same file location as when the *objtf* file was saved.

STL file loading preference If there are identically named *stl* files in more than one location, you need to ensure that the correct component *stl* files are linked to the *objtf* file. For example, if there are identically named *stl* files on one drive and on a flash drive (this can occur if you copy the original files to a working folder), you can set the default location from which files are loaded.

To set the Load Order:

1. From the *Tools* menu, select *Options*.
or—
In the *Objet Studio Commands* menu , click *Options*.
2. In the *Options* dialog box, display the *Settings* tab.

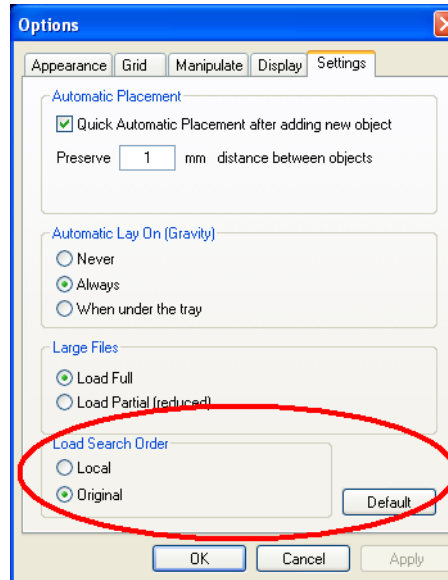

Figure 5-16: *Options* dialog box, *Settings* tab

3. Under *Load Search Order*, select an option:
 - **Local**—to load files from the location where they were last saved.
 - **Original**—to load files in their original location.
4. Click **OK**.

Quick-Access Model Commands

You can access common commands for working with objects on the build tray with the convenient Model Toolbar and context menus.

Model Toolbar Select an object in the tray to display the Model Toolbar that contains icons to perform common tasks.

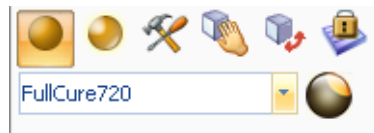









Figure 5-17: Model Toolbar

The table below describes the Model Toolbar icons.

Icon	Description
	Applies a matte finish to the model.
	Applies a glossy finish to the model.
	Opens the <i>Advanced Properties</i> dialog box for setting the Grid Style and the Hollow option.
	Enables dragging an object (see page 5-33).
	Opens the <i>Transform</i> dialog box for changing the object's position and scale.
	Toggles the Lock Model Orientation setting.
	Allows you to choose the printing materials.
	Enables you to apply a coating to the model, or change the coating previously applied.

Right-click model menu If you right-click on an object, a pop-up context menu is displayed from which you can also select the model finish, change its position and scale, and set the *Grid Style* and *Hollow* options.



You can also create a Quick Access toolbar with your most commonly used icons grouped together. See “Creating a Quick Access Toolbar” on page 59.

Copying and Pasting Objects

If you need to duplicate objects on the build tray, you can insert the same object from its file more than once. An easier way, however, is to copy and paste the object. You can copy objects from the build tray or the model tree—individual or multiple parts or assemblies. The objects copied remain in the Windows clipboard until you paste them onto the build tray.

You can also copy objects from one tray and paste them onto another, in the same way as you copy text from one document and paste it into another one. However, Objet Studio allows only one tray to be open at a time. For each build tray you need to work with (at the same time), you must open a separate Objet Studio window, by running the application again (from the Windows *Start* menu).



Having multiple Objet Studio windows open can be convenient when you need to manipulate or configure objects before inserting them in your production build tray. For example, if you need to change the model material of an object (saved as an *objdf* file) to match the model material already used in the production build tray, you must do so *before* inserting the object—on another tray. Copying and pasting also allows you to use objects already configured on previously-used build trays for newer projects.

You perform the *Copy* and *Paste* commands as in other Windows applications:

- from the right-click context menu.
- by using keyboard shortcuts (Ctrl+C and Ctrl+V, respectively).

The *Paste Special* command (from the object's right-click context menu) enables you to place duplicate objects even more efficiently:

- You can specify the number of duplicates to place on the build tray at once.
- You can set the distance, on each axis, between the duplicate objects.
- You can manipulate mirror images of the original object, and flip them on selected axes.

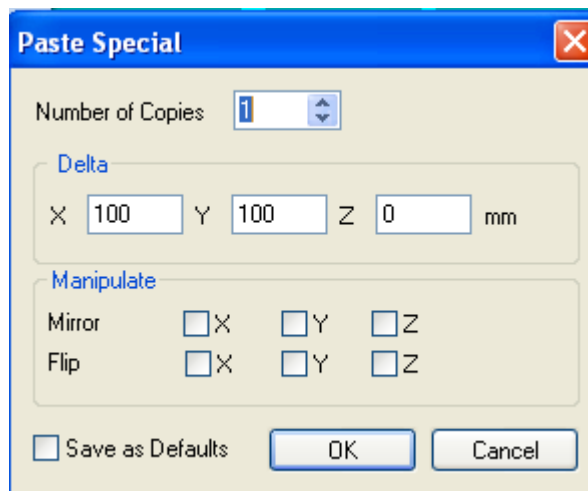

Figure 5-18: *Paste Special* dialog box

Selecting Objects

To manipulate an object on the build tray or assign characteristics to it (model material, building style etc.), you must first select the object. You select an object by clicking it, either on the tray or in the model tree. Its image on the build tray changes color (to light blue, by default) and its name is highlighted in the model tree. You can select multiple objects by drawing a box around them with the mouse cursor, or by pressing the Ctrl or Shift keys while clicking additional objects.

Alternatively, select or de-select objects using the following *Edit* menu commands:

- Select All
- Invert Selection
- Undo Select object

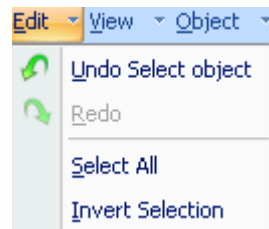



Figure 5-19: *Edit* menu

Sometimes, you need to select individual elements of an assembly. Other times, you need to select the entire assembly. The *Selection* icon displayed on the ribbon determines what will be selected when you click on the model:



To change the selection action:

1. On the *Tray Settings* or *Model Settings* ribbon—

- a. Click the *Selection* icon:  or .
- b. On the flyout toolbar, click the appropriate icon:

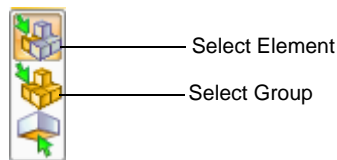

Figure 5-20: *Selection* flyout toolbar

Splitting Objects into Components

You can convert a complex object to an assembly of component parts. To do so, you split the *stl* file that represents the object into a group of separate *stl* files, each one representing a component. (This is referred to in the Objet Studio interface as separating the object into *shells*.) You can then assign a model material to each *stl* file, and you can save the newly-created assembly as an *objdf* file.

To split an object into an assembly of component parts:

1. If the object is not displayed, place it on the build tray by inserting its *stl* file (see “Placing Objects on the Build Tray” on page 10).

The object appears—on the build tray and in the model tree pane—as a single part. It is assigned, by default, the “primary” model material. (If Objet Studio is configured with a secondary material, you can assign it—or a *digital material*—to the entire object. This is explained in “Model-Material Settings” on page 20.)

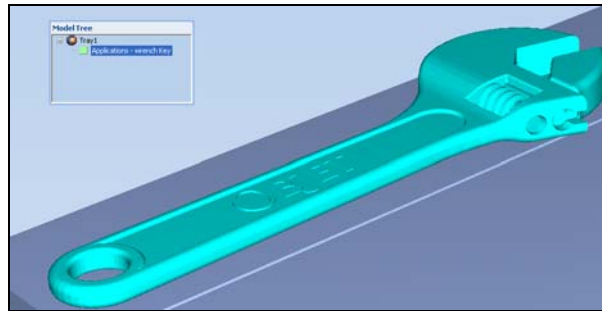



Figure 5-21: Object placed on the build tray from a single *stl* file

Note: There is no need to resize or arrange the object on the build tray at this time.

2. With the object selected:
 - From the *Object* menu, select *Separate into Shells*.
 - or—
 - On the ribbon, click  *Separate to Shells*.

A dialog box opens in which you can specify where to save the component *stl* files. (By default, Objet Studio offers to save the new files in a folder in the same location as the original *stl* file.)

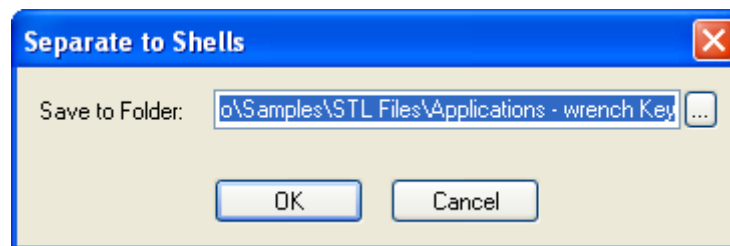

Figure 5-22: Folder selection for saving *stl* files after splitting into shells

3. Click OK.
Objet Studio splits the object into an assembly of component parts, each a separate *stl* file (“shell”).

The object appears—on the build tray and in the model tree—as an assembly of parts (“shells”). You can assign each part a different model material (This is explained in “Model-Material Settings” on page 20).

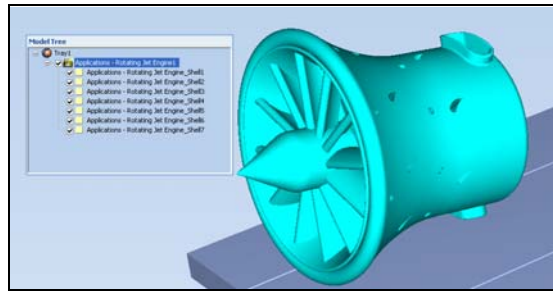

Figure 5-23: Object after being converted to an assembly of component parts

Model-Material Settings

Before placing objects on the build tray in Objet Studio, you should pay attention to the material selection settings on the *Tray Settings* ribbon.

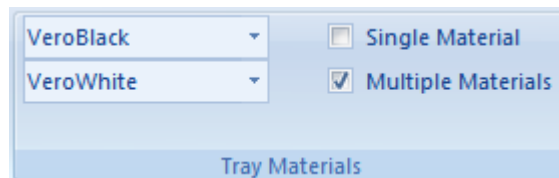

Figure 5-24: Material selection settings

- By default, the material selection settings on the ribbon correspond to the two model cartridges loaded in the printer.
- The materials displayed are basic model materials. These materials can later be combined to create digital materials (see “Digital Materials” on page 22).
- The material displayed on the top (VeroBlack, in the figure above) is considered the *primary* model material (“Model-1”). It is assigned to objects that do not have a material assignment when you place them on the build tray. For example, since *stl* files do not contain information about the model material, Objet Studio assigns the primary model material to them. Also, if you try to insert *objdf* files whose assigned materials are not recognized by your version of Objet Studio, you can insert the file by substituting the primary model material for the missing materials.
- Select Single Material if you want to print using only one material—both of the material drop-down menus contain the same material. If you decide to print with multiple materials, the material in the top drop-down menu remains assigned to the object until you select another material.
- If you insert an *objdf* file into an empty build tray, and the model-material assignment does not match the settings on the *Tray Settings* ribbon, these settings are changed automatically. However, if there is an

object already on the build tray whose materials do not match the material assignment in the *objdf* file, you cannot place the new object on the tray. To print this object, you have the following options:

- Instead of printing it on the same build tray, print the new object as a separate job.
- Change the materials assigned to objects on the build tray to match those assigned to the new object (see “Changing the Model Material” and “Assigning a Model Material to Objects,” below).
- Change the materials assigned to the new object before inserting it, so there is no conflict with the settings on the *Tray Settings* ribbon.

To change the materials assigned to an object before inserting it:

1. Open another Objet Studio window, by running the application from the Windows *Start* menu.
2. Insert the new object (*objdf* file) into the empty build tray.
3. Change the material selection settings on the *Tray Settings* ribbon to those used on the other build tray.
4. Assign materials to the object (see “Assigning a Model Material to Objects” on page 23).
5. Select the object and copy it.
6. Display the other Objet Studio window, and paste the object onto the build tray.

Note: You can save the object with the new materials either as a new *objdf* file, or by saving the original file with the changes.

Changing the Model Material

When you design a build tray in Objet Studio, you can use model materials that might not be currently installed in the printer. Because the installed materials are displayed by default, change the material selection settings on the *Tray Settings* ribbon, if necessary.

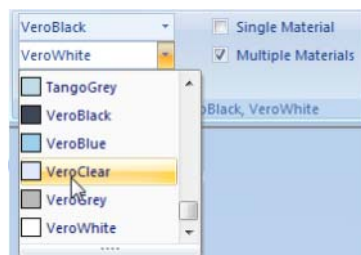

Figure 5-25: Selecting a new model material



When you send the job to the print queue, you indicate whether or not you allow substitute materials to be used—see “Model Material Substitution” on page 51.

Digital Materials

When two different model materials appear on the ribbon, you can produce objects from either material or from a combination of them—*digital materials*. Different pairs of model materials enable you to print objects using unique digital materials. Certain digital materials can produce objects with different shades of color. Combinations of model materials that have different mechanical properties result in digital materials with unique characteristics.

To view the digital materials available for printing objects (using two basic model materials):

1. Make sure that you have selected the appropriate model materials, and that Multiple Materials is selected.

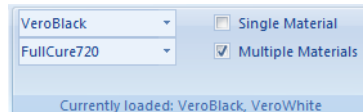

Figure 5-26: Material selection with two basic model materials

2. Click  .

The Material Selection Guide appears, showing the basic model materials (at the top of the list) and the digital materials available (combinations of them).

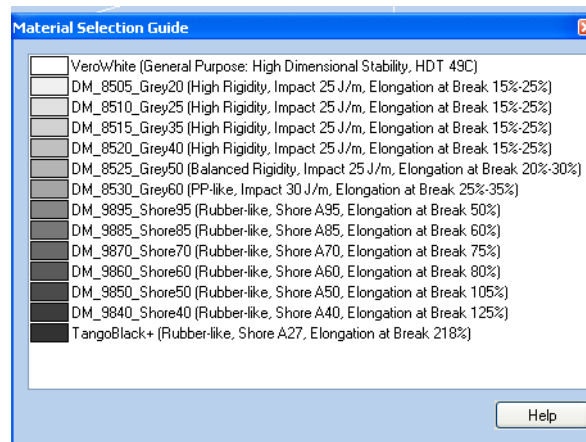

Figure 5-27: Material Selection Guide, showing the digital materials available with the basic model materials

Assigning a Model Material to Objects

You can assign any of the available digital materials to objects on the build tray.

To assign a model material to objects:

1. Select an object on the build tray (see “Selecting Objects” on page 18).
When an object is selected, its properties—including model materials—are displayed on the Model Toolbar and on the ribbon.

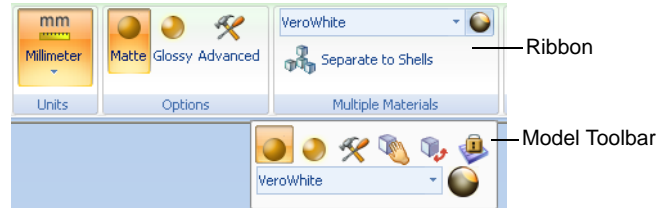

Figure 5-28: Object properties, on ribbon and Model Toolbar

2. Display the material drop-down list and select the desired material.

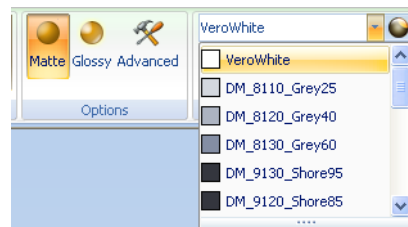

Figure 5-29: Menu for assigning materials to objects



When you de-select the object on the build tray, it is displayed, by default, with the color of the material you selected. In the same way, you can assign model materials to each of the independent objects on the build tray.



To separate an object into independent, component parts (each an *stl* file), see “Splitting Objects into Components” on page 19.

Surface Finish Models can be printed with a matte or glossy surface finish. To create a matte finish, the printer surrounds models with a thin layer of support material.

To set the model finish:

1. Select the model.
2. Select Matte  or Glossy  in one of the following places:
 - *Model Settings* ribbon, *Options* group
 - Model Toolbar
 - right-click context menu (when selecting the model)

You can configure Objet Studio to distinguish between objects' surface finish on the build tray by color. To configure how Objet Studio displays objects, see "Setting Object Colors" on page 43.

Coating Objects

You can print composite models where the surface layer is a different material than the inside. This can be useful to achieve unique mechanical and textural characteristics. This technique is called "coating."

To coat an object with a different model material:

1. Select an object on the build tray.
2. On the Model Toolbar or the *Model Settings* ribbon, click . The *Coat with* dialog box opens.
3. Select Coat With and, from the drop-down list, select the coating material.

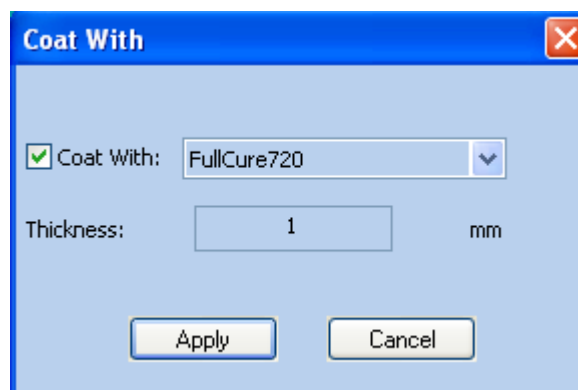

Figure 5-30: Coating material selected

4. In the *Thickness* field, enter a coating thickness between 0.3 and 3 millimeters.

Note: The coating thickness does not affect the external dimensions of the object, which remain unchanged. The coating layer replaces part of the main model material.

5. Click Apply.

Note: When you de-select objects, they are displayed, by default, with colors representing the model-material. Even after adding a coating to an object, its color remains that of the main material, not the color of the coating material.

Assigning Properties to Hidden Objects

To inspect, modify or remove the coating applied to an object:

1. On the Model Toolbar or the *Model Settings* ribbon, click . The *Coat with* dialog box opens.
2. Perform one of the following actions—
 - Change the coating settings, and click Apply.
 - To remove the coating, clear the *Coat With* check box and click Apply.
 - To keep the current coating settings, click Apply or Cancel.

To enable you to assign materials and other properties to parts of objects that are hidden from view on the build tray display, you can temporarily turn off the display of some objects.

To prevent the display of objects:

1. Right-click an object, either on the build tray or in the model tree.
2. From the menu that opens, select one of the following options—
 - **Hide**, to cause the selected object to disappear.
 - **Hide Others**, to cause all other objects on the build tray to disappear, so that only the selected object is displayed.

Alternately, you can clear the check box next to the name of the object in the model tree to cause that object to disappear.

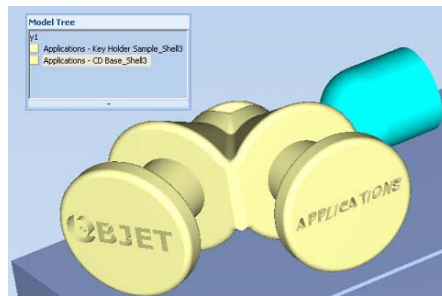

Figure 5-31: All objects displayed

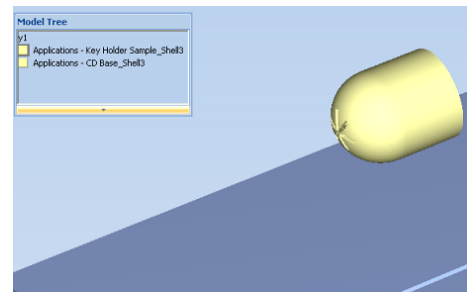

Figure 5-32: Outer object hidden

Positioning Objects on the Build Tray

To produce models efficiently and with the required finish, it is important to carefully position objects on the build tray. Objet Studio supports the automatic positioning of objects. However, you should check to make sure that the objects are orientated optimally for your needs, according to the considerations explained in “Model Orientation” on page 28.

Two things that affect the positioning of objects on the build tray are *orientation* and *placement*. You can let Objet Studio determine the optimum orientation and position, or you can control them.

Automatic Orientation

By default, Objet Studio automatically orients objects, when placed on the build tray, for the shortest printing time. (You can later change the orientation manually.) However, you can cancel automatic orientation when placing an object on the build tray.

To place an object on the build tray without automatic orientation:

- In the *Insert* dialog box, make sure *Orient Automatically* is **not** selected.

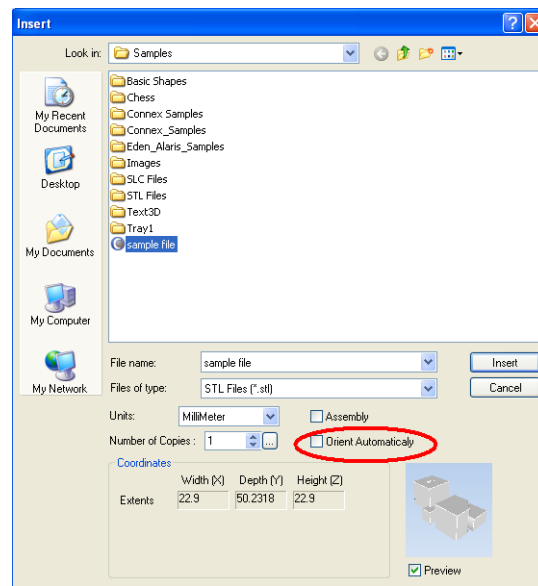

Figure 5-33: *Orient Automatically* option disabled



You can change the default setting, so that automatic orientation is *not* applied unless you select the *Orient Automatically* check box each time you place an object on the build tray. To do this, see “Default Settings” on page 65.

Automatic Placement

After placing several objects on the build tray, you can let Objet Studio arrange them before printing. This ensures that the objects are positioned properly, and that they will be printed in the shortest time and with a minimum of material.

To automatically arrange objects on the build tray:

- On the *Tray Settings* ribbon, click  *Placement*.
- or—
- From the *Tools* menu, select *Automatic Placement*.

The effects of automatic positioning are shown in the figures below.

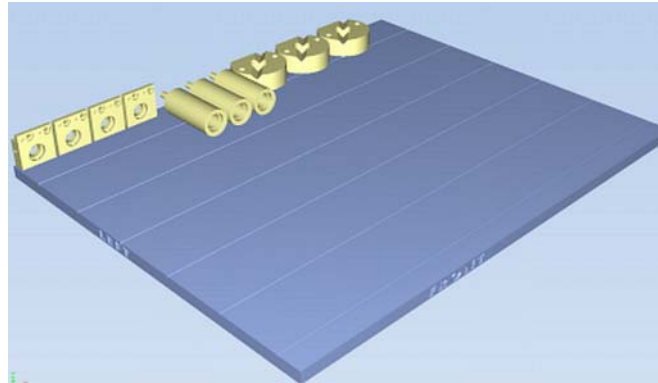

Figure 5-34: Tray before objects are properly arranged

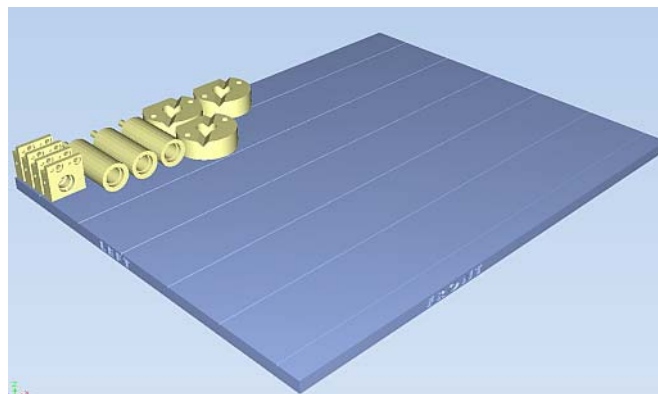

Figure 5-35: Tray arrangement after applying Automatic Placement



- For best results, arrange the tray with *Automatic Placement*, on the *Tray Settings* ribbon, even if you inserted the objects with the *Orient Automatically* option.
- The physical characteristics of each type of Model material you use can affect the positioning of objects on the tray. Therefore, select materials **before** running *Automatic Placement*.

Manual Positioning

You can change the position of objects on the build tray—even if they were inserted with the *Orient Automatically* option. Considerations for positioning objects are presented in “Model Orientation,” below. Tools for changing the position of objects are presented in “Manipulating Objects on the Build Tray” on page 29.

Model Orientation

The orientation of models on the build tray affects how quickly and efficiently they will be produced by the 3D printer, where and how much support material is used, and whether or not model parts will have a glossy finish. Therefore, you should consider a variety of factors when deciding how to place models on the tray, using the following positioning rules.

X-Y-Z Rule

This rule considers a model's outer dimensions.

- Since the print heads move back and forth along the X-axis, the printing time along this axis is relatively short, compared to printing time along the Y-axis and Z-axis. From this point of view, it is advisable to place the object's *largest* dimension along the X-axis.
- Any surfaces that come into contact with support materials become matte.
- Since models are built up, on the Z-axis, in 16- or 30-micron layers (according to the printing mode), it is very time-consuming to print a tall object. From this point of view, it is advisable to place the object's *smallest* dimension along the Z-axis.
- Since the print heads measure about 2 inches (5 centimeters) on the Y-axis, models measuring less than this (on the Y-axis) are printed in one pass. From this point of view, it is advisable to place the object's *intermediate* dimension along the Y-axis.

Tall-Left Rule

This rule considers models where, after being orientated on the build tray according to other considerations, one side is taller than the other.

- Since the print heads move along the X-axis from left to right, taller sections on the right require the print heads to scan unnecessarily from the left until reaching them. If, on the other hand, the taller sections are positioned on the left of the tray, the print heads only have to scan the model until printing these sections—once the lower parts have been completed. Therefore, you should position the taller side of the model, when possible, *on the left*.



The following rules are based on the fact that support material is not required on the top of the printed model.

Recess-Up Rule

This rule considers models containing surface recesses.

- Recesses in the surface (like hollows, drill holes, etc.) should, when possible, be positioned *face-up*.

Fine-Surface Rule

This rule considers models that have one side on which there are fine details (like the keypad side of a telephone).

- The side of the model containing fine details should, when possible, be positioned *face-up*. This results in a smooth finish.

Avoid Support-Material Rule

This rule considers models that have large holes or hollows, open on at least one side (like a pipe or a container).

- It may be advantageous to print a model *standing up*, so support material does not fill the hollow, even though printing the model lying down would be much faster.

Manipulating Objects on the Build Tray

Positioning Objects on the Z-Axis

When you use the automatic positioning option to arrange objects on the build tray (see “Automatic Orientation” on page 26), the objects are positioned directly on the tray. If you do not insert objects with automatic positioning, they often appear either above or below the tray.



In practice, the Connex system prints all models on the build tray on a one-millimeter bed of support material. The importance of positioning objects directly on the build tray with Objet Studio is to correctly display the objects on the screen.

To position objects directly on the tray:

1. Select the object.
2. From the *Object* menu, select Lay On.

To ensure that objects are always positioned directly on the tray:

1. From the *Tools* menu, select Options, and display the *Settings* tab.

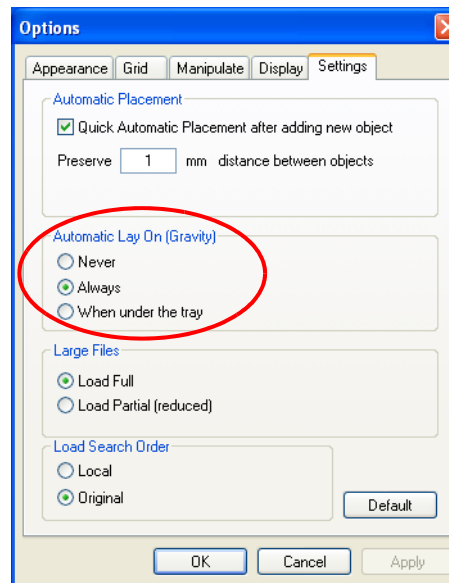

Figure 5-36: Options dialog box, Settings tab

2. In the *Automatic Lay On (Gravity)* section, select Always.

Other Z-axis options (in the *Automatic Lay On* section):

- When under the tray—The display of objects that are below the build tray is automatically changed so that the object is at tray level.
- Never—The display of objects that are above or below the build tray is not changed.

Valid Object Placement

You can ensure that models do not overlap when you position them on the build tray, and that they do not extend beyond the tray.

To ensure valid object placement:

1. From the *Tools* menu, select *Constraints Settings*.

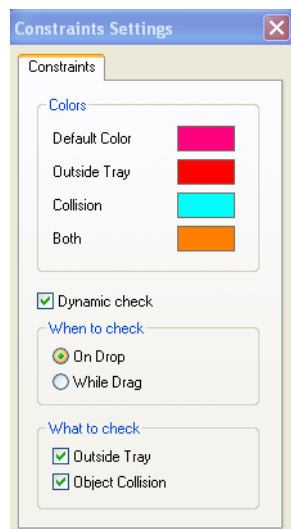

Figure 5-37: *Constraints Settings* dialog box

2. Select *Dynamic check* to identify—
 - invalid object placement while placing objects—*On Drop* selected.
 - invalid object placement after moving objects—*While Drag* selected.
 - objects placed beyond the tray’s boundaries—*Outside Tray* selected.
 - objects that overlap—*Object Collision* selected.



Even if you do not use *Dynamic Check* when placing objects on the build tray, Objet Studio automatically checks if there is a problem with the positioning of objects on the tray before sending it to the printer. You can also manually check for problems after positioning objects (see “Tray Validation” on page 47).

Note: Because of the unique characteristics of each type of model material and finish, always check valid placement after changing the material/finish. Remember that Objet Studio calculates the space occupied by an object including the “bounding box” surrounding it (see figure 5-52 on page 40).

Using a Grid to Position Objects

Displaying a grid on the image of the build tray can be useful when positioning objects. To use the grid features, select the following menu options.

Menu Option	Result
Tools > Grid	Displays a grid on the build tray.
Tools > Snap to grid	When moving the object, it aligns with the nearest grid line.
Tools > Options > Grid	Enables you to change the grid origin (X- and Y-axis meeting point) and appearance.

You can review and configure grid settings—and apply them—from the *Options* dialog box.

To view and change grid settings:

1. From the *Tools* menu, select *Options*, and display the *Grid* tab.

The current grid settings are displayed.

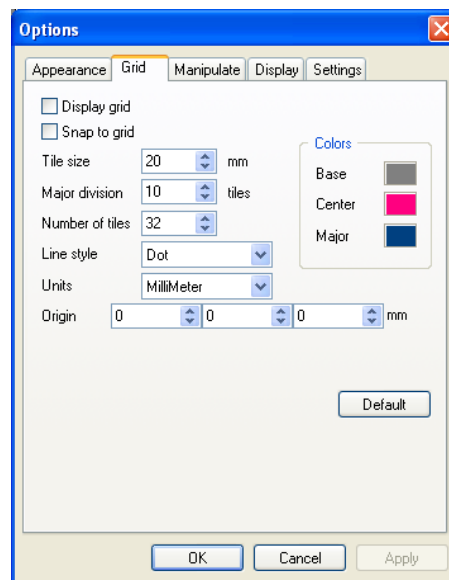

Figure 5-38: *Options* dialog box, *Grid* tab

2. As required, change the settings, and select or clear the check boxes.
3. Click *Apply* or *OK*.

Measurement Units

3D files contain an object's proportions, but not its units of measure. Therefore, make sure to correctly select either millimeters or inches when inserting an object. Otherwise, the size of the object on the build tray will be either much too large or much too small.

To set the measurement units when inserting an object:

- In the *Insert* dialog box, *Units* field, select Millimeter or Inch:

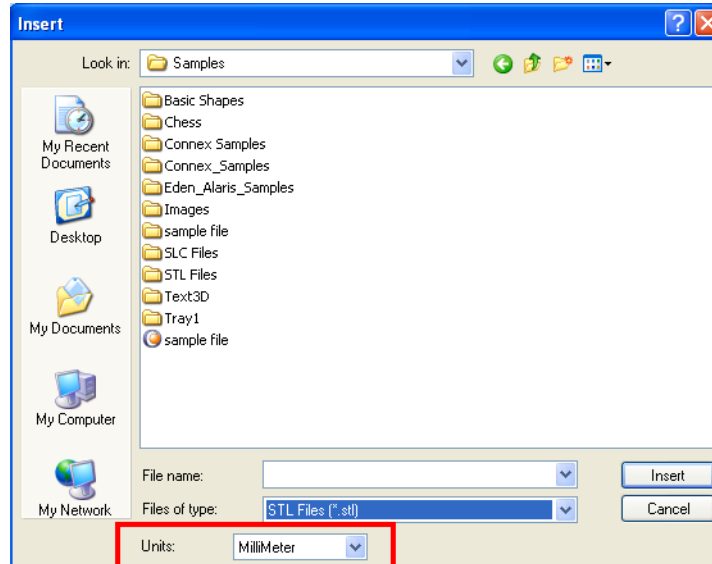

Figure 5-39: *Units* field in the *Insert* dialog box

To change measurement units for a selected object from the *Model Settings* ribbon:

1. Open the *Units* flyout toolbar.



Figure 5-40: *Units* flyout toolbar

2. Select the measurement units desired.

To change measurement units for a selected object from the standard toolbar:

1. From the *Object* menu, select Change Units.

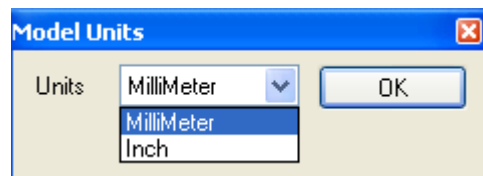

Figure 5-41: *Model Units* dialog box

2. In the *Model Units* dialog box, change the setting and click OK.

Setting Model Dimensions

You can change an object's dimensions by changing its size on the X-, Y-, and Z-axes, from the *Dimensions* group on the *Model Settings* ribbon.



Figure 5-42: *Dimensions* on the *Model Settings* ribbon

- If *Uniform Scale* is enabled, changing the object's dimension on one axis affects the other dimensions, proportionately.
- After changing a measurement, press Enter or click in another field in the *Dimensions* group.

Note: You can change the height of the objects on the build tray only if this is allowed by the Objet Studio settings (see “Positioning Objects on the Z-Axis” on page 29).

Repositioning Objects

You can manually move and rotate an object on the build tray with the arrow keys, or by dragging it with the mouse.

To manually manipulate an object:

1. Select an object by clicking it on the build tray, or in the model tree pane.
2. Click  on the Model Toolbar, or on the *Model Settings* ribbon.

A frame appears around the object, and the cursor changes to indicate that the object can be moved.

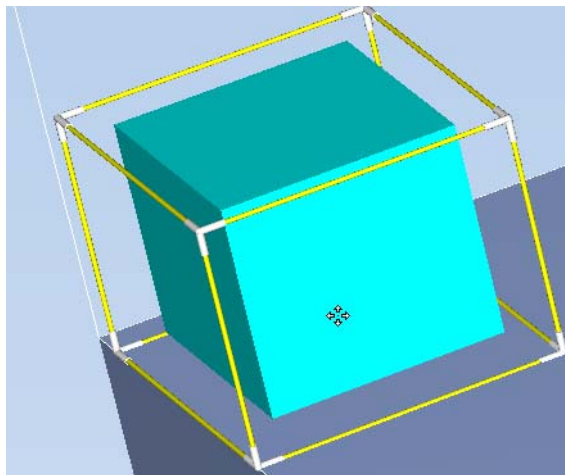

Figure 5-43: Manually moving an object

- If you click on a corner of the frame, the cursor changes to indicate that the object can be rotated.

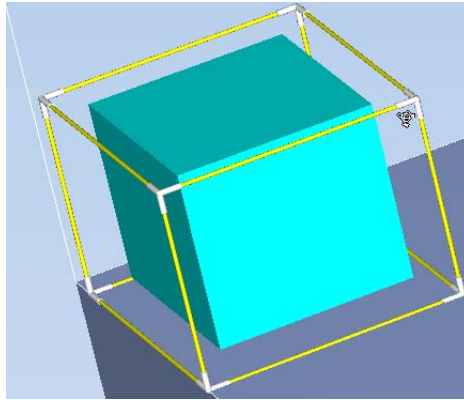

Figure 5-44: Manually rotating an object

- Manipulate the object with the arrow keys or with the mouse.

Using the *Transform* Dialog Box

You can make precise changes to an object by changing the properties in the *Transform* dialog box.

To access the *Transform* dialog box (when an object is selected):

- Click  on the Model Toolbar or on the *Model Settings* ribbon.
- From the right-click context menu, select *Transform*.
- From the *Object* menu, select *Transform*.



Figure 5-45: *Transform* dialog box

To change an object with the *Transform* dialog box:

- Change any of the values, then click *Apply* to see how the object changes on the build tray.

Note: The changed values remain in the dialog box after clicking *Apply*. Therefore, you can make small changes to values in the dialog box to see how the object changes on screen each time you click *Apply*.

To reset all of the values in the dialog box:

- Click *Reset*.

Note: The object does not change. Any changes previously applied remain.

To undo **all** changes made with the *Transform* dialog box:

- Click *Cancel Actions*.



After closing the *Transform* dialog box, clicking *Undo* (on the *Model Settings* ribbon or from the *Edit* menu) cancels **all** changes made with the dialog box.

Changing an Object's Orientation



There are several methods for changing the orientation of objects on the build tray.

To rotate an object:

- Select the object and use the *Object* menu options (see also “Repositioning Objects” on page 33).

To re-align an object's plane:

1. On the *Tray Settings* or *Model Settings* ribbon—

- a. Click the icon in the *Selection* group:  or .
- b. On the flyout toolbar, click the *Select Plane* icon:



or—

From the *Tools* menu, select *Plane Alignment > Select Plane*.

2. Click on part of an object on the build tray.
The selected plane is displayed.

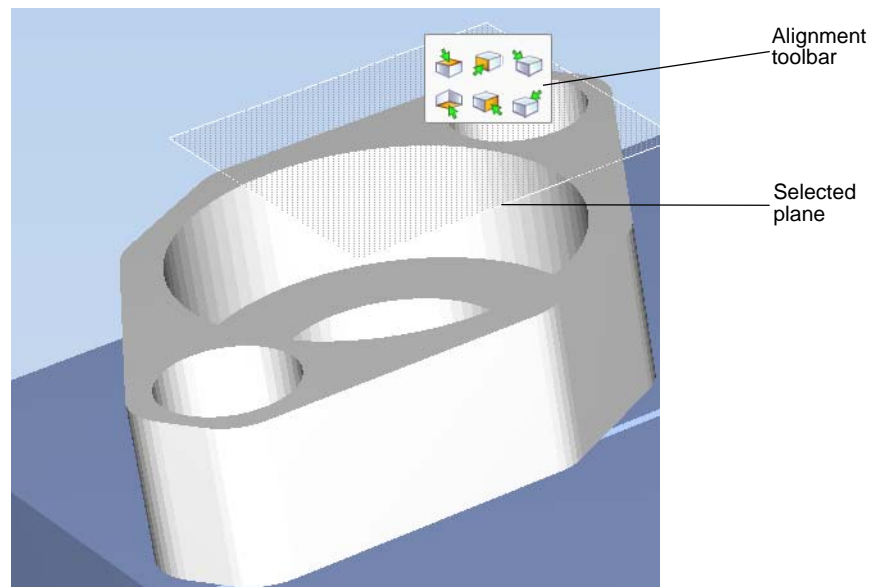

Figure 5-46: Aligning by plane

3. On the *Alignment toolbar*, click an appropriate icon to change the alignment.

or—

From the *Tools* menu, select *Plane Alignment*, and select an alignment option.

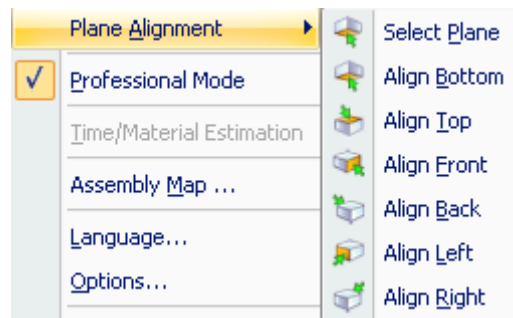

Figure 5-47: Tools menu, Plane Alignment options

To cancel plane selection after re-aligning objects on the build tray:

➤ On the *Tray Settings* or *Model Settings* ribbon—

a. Click the icon in the *Selection* group:



OR

b. On the flyout toolbar, click the *Select Element* or *Select Group* icon:



OR—

➤ From the *Tools* menu, select *Plane Alignment* > *Select Plane*.

To flip an object 180 degrees on any axis:

1. Select the object.
2. From the *Object* menu, select *Flip* > *Flip X* / *Flip Y* / *Flip Z*.

To make precise changes to the object's orientation on any axis:

1. Select the object.
2. Display the *Transform* dialog box (see figure 5-45 on page 34).
3. Change the *Rotate* parameters for each axis.

Grouping and Ungrouping Objects

You can manipulate two or more objects on the build tray, at the same time.

- Selecting multiple objects

Manipulating done to one object affects all selected objects. For example, turning one object on its axis causes all selected objects to turn on their respective axes.

- Converting the objects to an assembly

Separate objects become parts of one unit. For example, turning the assembly on its axis causes all its component parts to turn as one unit.

To convert objects to an assembly:

1. Select the objects (see “Selecting Objects” on page 18)
2. From the *Object* menu, select *Group to Assembly*.

In the model tree, the objects now appear as children of a parent (assembly).

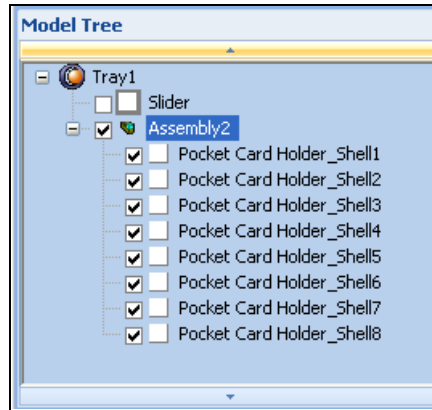



Figure 5-48: Assembly in the model tree



The model tree does not display the assembly file name unless you open (insert) it as an *objdf* file.

After creating an assembly, you can save it as an *objdf* file, for re-use. (Saving the assembly is not necessary for manipulating and printing it.)

To save an assembly:

1. Select the assembly (either on the build tray or in the model tree).
2. From the Objet Studio Commands menu , select Save As.
3. In the *Save As* dialog box, select the *objdf* format, choose a location, name the file, and click Save.

To separate assemblies into individual objects (*stl* files):

1. Select the assembly (either on the build tray or in the model tree).
2. From the *Object* menu, select Ungroup.

In the model tree, the elements are not parts of an assembly.

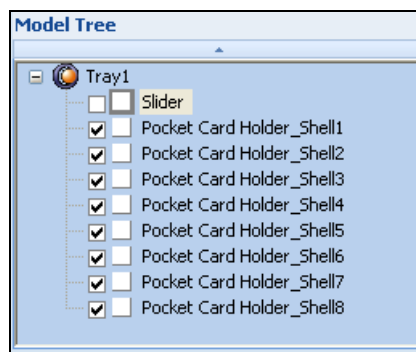



Figure 5-49: Separate objects in the model tree

Freezing Model Orientation

If you manipulate an object on the build tray, you can freeze its orientation so that it does not change when you position it automatically (see “Automatic Placement” on page 27).

To freeze an object:

1. Select an object on the build tray.
2. On the *Model Settings* ribbon, in the *Manipulate* group, or on the Model Toolbar, click .

To unfreeze an object:

- Select the object and click  (to de-select it).

Display Options

Viewing Objects

From the *View* menu, you can change the way objects are displayed. The default method for displaying models on the build tray is as solid (“shaded”) objects.

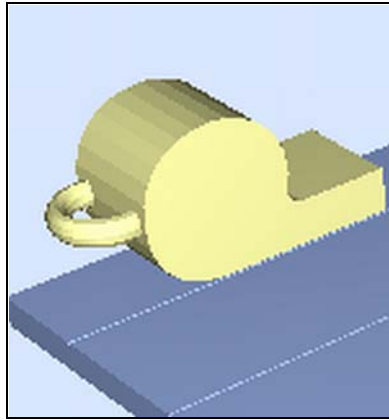

Figure 5-50: Tray and model displayed in *Shaded* view

The other display options are *WireFrame* and *Points*.

To display the build tray in *WireFrame* view:

- From the *View* menu, select *WireFrame*.

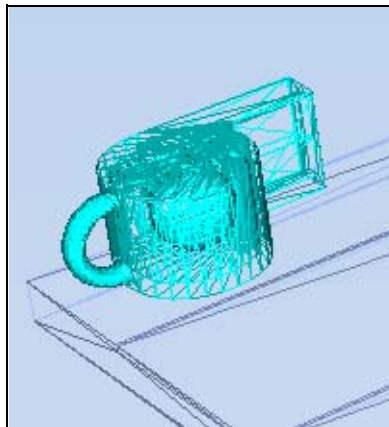

Figure 5-51: Tray and model displayed in *WireFrame* view

To revert to the *shaded* view:

- From the *View* menu, select *Shaded*.

To display objects as boxes, showing their maximum dimensions instead of their shape:

- From the *View* menu, select *Display Bounding Box*.

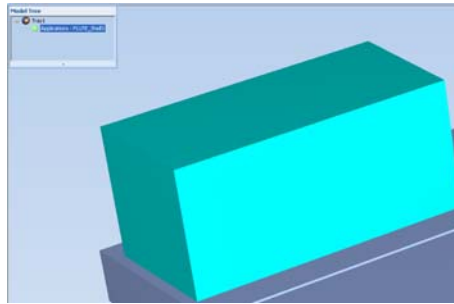

Figure 5-52: Model displayed with bounding box

To display the area around objects needed for support material (to produce a matte finish):

- From the *View* menu, select *Display Thickening Box*.

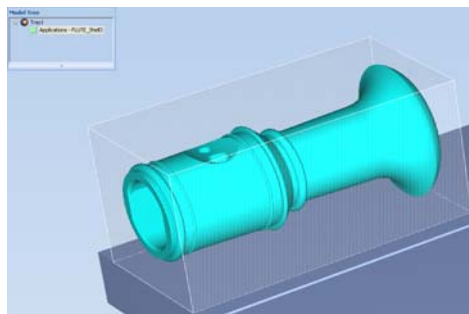

Figure 5-53: Model displayed with thickening box

To display the maximum build height:

- From the *View* menu, select *Display Tray 3D Box*.

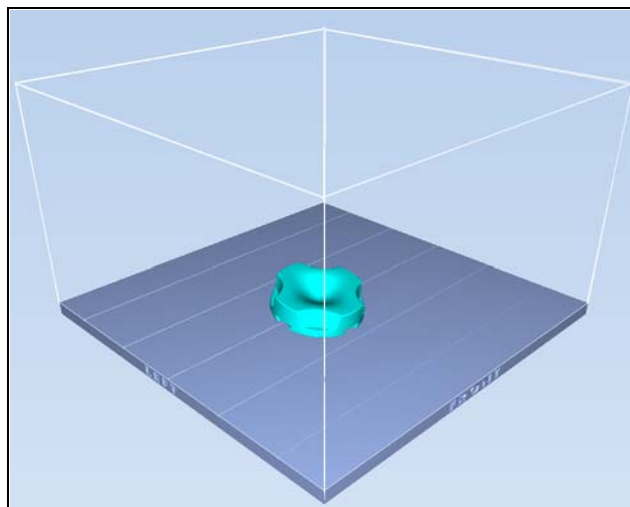

Figure 5-54: Tray 3D Box

To display objects without the build tray:

- From the *View* menu, clear (de-select) the *Display Tray* option.

Screen Layout Objet Studio automatically adjusts the default screen layout to display the optimum views of the build tray and the model tree. You can view models from different perspectives by changing the screen layout.

To change the screen layout:

- On the *View* flyout toolbar, select *Single View*, or *4 Views*.

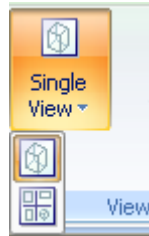



Figure 5-55: Screen layout icons

- Single View*  is the default screen layout.
- 4 Views*  displays *perspective, top, front* and *right* views.

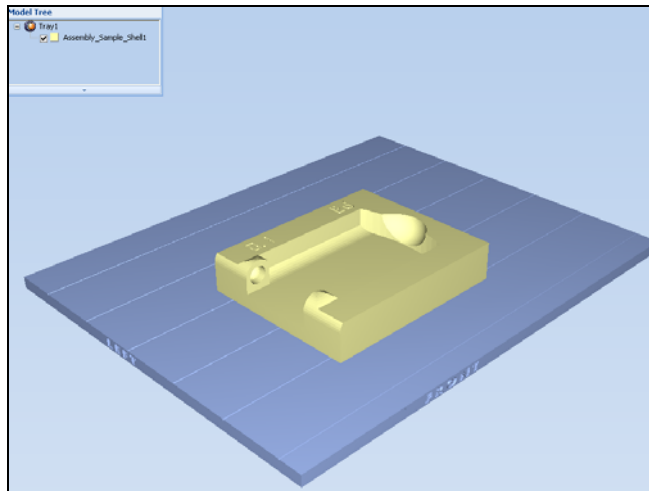

Figure 5-56: Single-view screen layout

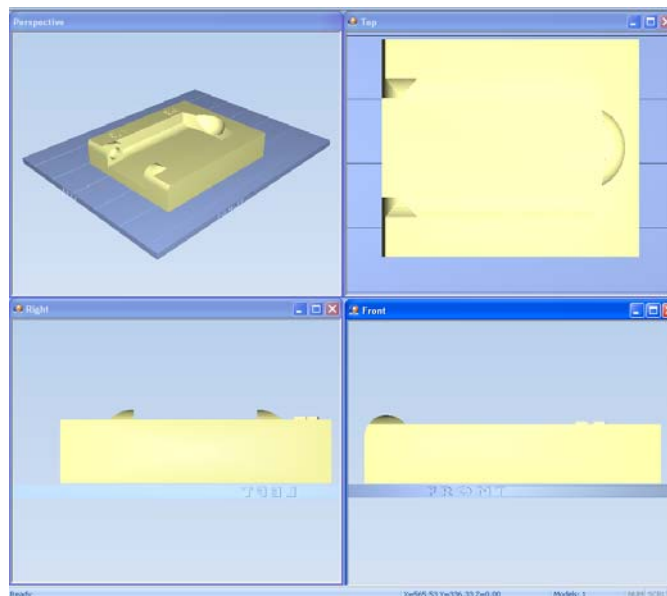

Figure 5-57: 4-view screen layout

Tray Perspective

The default perspective of the build tray is “isometric.” You can change the perspective of the active window with one of ten options.

To change the perspective of the build tray in the active window:

1. On the *Tray Settings* ribbon, open the *Perspective* flyout toolbar.



Figure 5-58: *Perspective* flyout toolbar

2. Click the icon that represents the desired perspective.

Tray Positioning

To view the tray and models from different directions, you can move the tray around the screen and change its display angle.

To move the tray in the Objet Studio screen:

- Press the mouse wheel while moving the mouse.

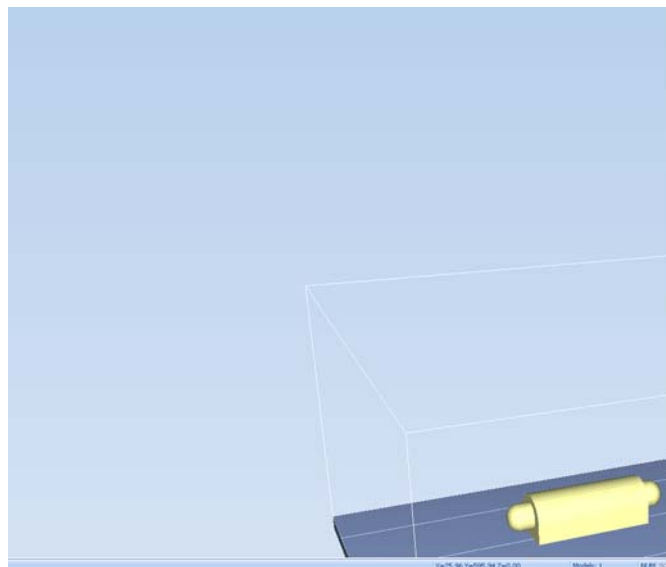

Figure 5-59: Tray after moving it in the Objet Studio display

To manually rotate the tray:

- Press Alt and press the mouse wheel while moving the mouse.

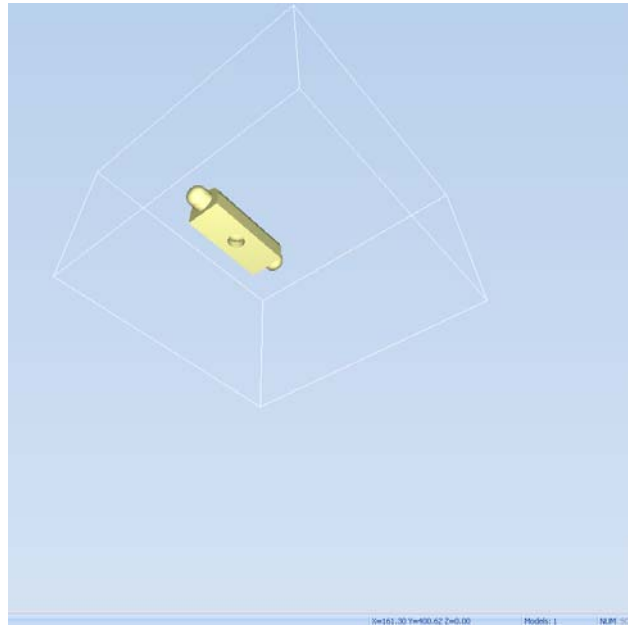

Figure 5-60: Tray after rotating it upside-down

Setting Object Colors

The color of objects on the build tray can indicate how they are printed. Objet Studio enables you to choose the color display so that you can easily see the material, surface and coating of objects.

To choose how colors are applied on the display:

- On the *Model Settings* ribbon, in the *Colors* group, select one of the options from the flyout toolbar.

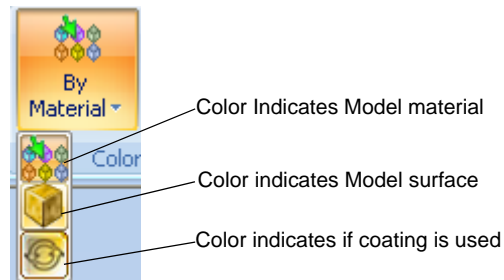

Figure 5-61: *Colors* display options



Before sending a build tray to the printer, or when you perform *tray validation*, Objet Studio checks if there is a problem with the *stl* files or the positioning of objects on the tray. If so, the affected objects are displayed with special colors (see “Tray Validation” on page 47).

Loading Large Files

Very large *stl* files can be slow to load and may be difficult to manipulate easily on the build tray. If this is the case, you can display just an image of the object on the build tray without loading the entire file. The *stl* file itself is not changed, and the complete file is sent to the printer.

To display an image of *stl* files when you place objects on the build tray:

1. From the *Tools* menu, select *Options*, and display the *Settings* tab.

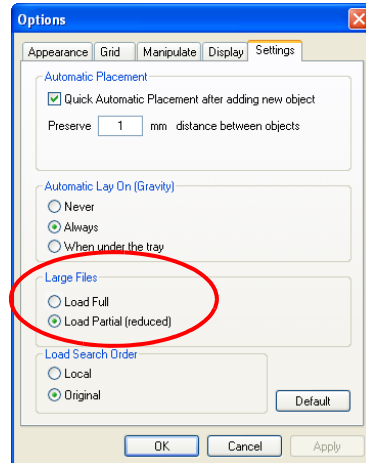

Figure 5-62: *Options* dialog box, *Settings* tab

2. In the *Large Files* section, select *Load Partial (reduced)*.

Large File Manipulation

If you need to work with a detailed model that is composed of a large number of polygons, you can speed up its display and manipulation in *Objet Studio* by reducing the number of polygons on the screen. Although this may reduce the resolution on the screen, it has no affect on the printed models.

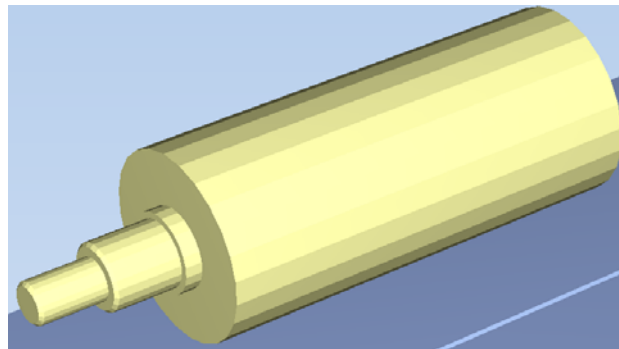

Figure 5-63: Object displayed without polygon reduction

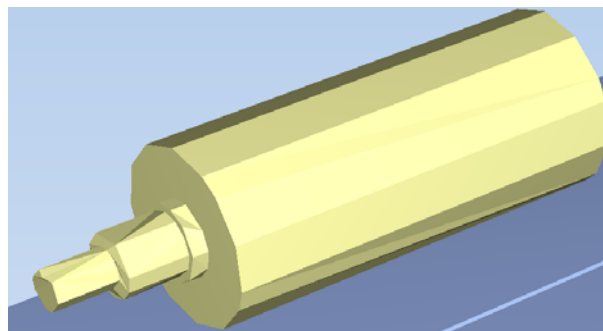



Figure 5-64: Object displayed with only five percent of its polygons showing

To use polygon reduction:

1. From the *Tools* menu, select *Options*.
or—
From the *Objet Studio Commands* menu , click *Options*.
2. In the *Options* dialog box, display the *Display* tab.

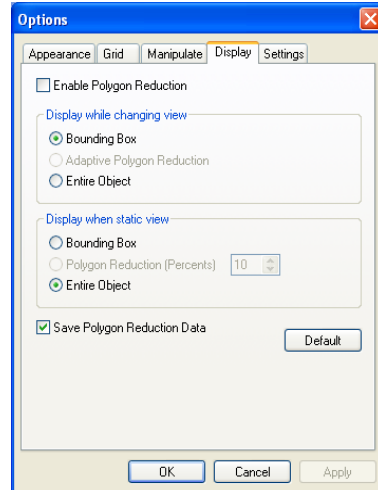

Figure 5-65: *Options* dialog box, *Display* tab

3. Select *Enable Polygon Reduction*.
4. Select *Polygon Reduction (Percent)*.
5. Enter the percentage of total polygons to display.
When you click *Apply*, the display changes.

Note: The setting affects the static display (when the object is not being moved).

6. Set display options when the object is being moved (*Display while changing view*):
 - *Bounding Box*—A box representing the object's maximum dimensions is displayed.
 - *Adaptive Polygon Reduction*—Varying degrees of polygon reduction are applied, as necessary.
 - *Entire Object*—No polygon reduction is applied.
7. To save these settings, so that they will be applied every time you place **this object** on the build tray, click *Save Polygon Reduction Data*.
8. Click *Apply* to see the results of the settings without closing the dialog box.



Selecting the *Entire Object* option cancels polygon reduction.

Object display options The display format affects how quickly objects display. For example, if you select **Bounding Box**, objects display faster than they do when you select **Entire Object**. You can choose display formats for objects when they are stationary (*static view*) and for when you are dragging them (*changing view*).

To select the object display preference while changing view, and in static view:

1. Select to display objects:
 - With a *Bounding Box* (see figure 5-52 on page 40)
 - With *Adaptive Polygon Reduction* (*changing view* only)
 - With *Polygon Reduction* (*static view* only)
 - *Entire Object*
2. Click OK when done.

Zoom Options While manipulating objects, you often need to view them at different zoom levels.

To change the zoom level:

➤ On the ribbon, open the *Zoom* flyout toolbar and select an option:

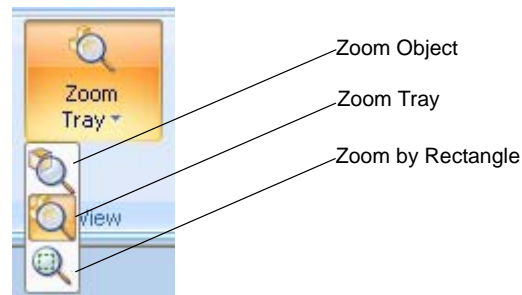

Figure 5-66: *Zoom* flyout toolbar

- Zoom Object* focuses on the selected object.
- Zoom Tray* displays the whole tray.
- Zoom by Rectangle* allows you to display a section of the tray by selecting it with the mouse.

You can also zoom in and zoom out with the mouse wheel.



You can configure Object Studio to automatically zoom in on the objects placed on the build tray. See “*Automatic Zoom*” on page 65.

Handling Completed Trays

After you have properly placed all objects on the build tray, you save the tray as an *objtf* file, which is sent to the 3D printer for production. But before saving the tray, you can check that there would be no problem producing it. You can also calculate how much material would be consumed during production and how much time this would take.

Tray Validation Before sending a job to the printer for production, you should check that the tray is “valid” and can be printed.

Note: Because of the unique characteristics of each type of modeling material, make sure that the correct material is selected *before* performing Tray Validation.

To validate that the tray can be printed:

- On the *Tray Settings* ribbon, in the *Build Process* group, click  **Validate**.

or—

From the *Tools* menu, select **Placement Validation**.

If the tray is not valid, the color of the problematic models on the tray changes according to a pre-set code.

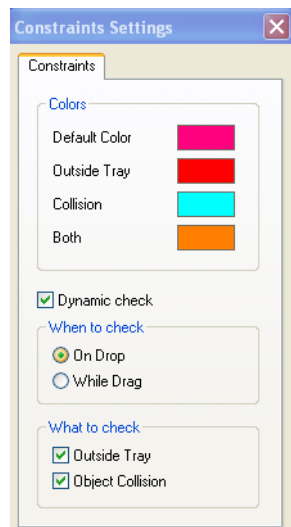

Figure 5-67: Color code

Note: The “Both” color also indicates a problematic *stl* file.

The validation status appears on the bar at the bottom of the screen.

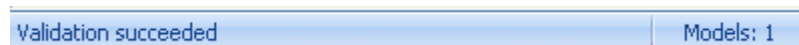



Figure 5-68: Validation details in status bar

Production Estimates

Objet Studio enables you to calculate the time and material resources needed for producing trays before sending them to the printer. The time it takes Objet Studio to perform this calculation depends on the number of objects on the tray and their complexity. Calculating the production estimate for a full tray could take up to 15 minutes, depending on your computer's specifications.

To calculate the time and materials needed for producing the current tray:

- On the *Tray Settings* ribbon, in the *Build Process* group, click  *Estimate*.

While the estimate is being calculated, a progress bar is displayed—on the right side of the status bar (at the bottom of the screen).



Figure 5-69: *Estimate* progress bar

When Objet Studio finishes calculating the production resources, the results are displayed in a dialog box.

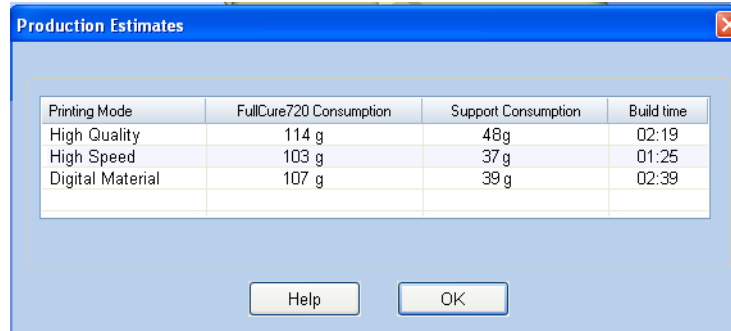

Printing Mode	FullCure720 Consumption	Support Consumption	Build time
High Quality	114 g	48g	02:19
High Speed	103 g	37 g	01:25
Digital Material	107 g	39 g	02:39

Figure 5-70: Production resource calculations for different printing modes

As shown in the *Production Estimates* dialog box, the resources needed for producing the models on the tray depend on the printing mode used by the printer when producing the job. You might want to consider these estimates when deciding on the printing mode (see below), and whether or not to allow using substitute model materials when printing the job.

Note: You select the printing mode and material substitute options after you send the build tray to the printer (see “Printing the Tray File” on page 50).

Printing Modes Connex printers can build models using three possible printing modes.

HQ (High Quality) Mode—

- Models are printed in 16-micron layers, resulting in smooth surfaces, suitable for producing fine-detailed and delicate items.
- Almost twice as much time is required to print most trays, compared to the High Speed setting.
- This setting is only available when model material can be used in four print heads, in *single-material printing*.



Single-material printing: All print heads print models without regard to the source of the model material. This happens in the following situations:

- All print heads are supplied with one model material.
- Each pair of print heads is supplied with a different model material, but models are printed *as if they were the same material*. The result is an arbitrary mixture of materials in the printed model.

HS (High Speed) Mode—

- Models are produced in 30-micron layers, suitable for producing larger models.
- Much less time is required to print most trays, compared to the High Quality setting.
- This setting is only available when model material can be used in four print heads, in *single-material printing*.

Digital Material Mode—

- Used when producing trays designed to be fabricated from two model materials.
- Used when producing a tray containing two or more models, each designed to be made from a different (single) model material.
- Used when producing models from only one of the model materials loaded in the printer by printing with only two of the print heads.
- Models are produced in 30-micron layers, but the printing is near-high quality.
- Printing time is similar to printing time in High Quality mode.

Although printing time is longer than with High Speed mode, Digital Material mode can make material replacement unnecessary—saving both time and the cost of wasted model material.



Digital Material Mode is selected automatically when more than one model material is assigned to objects on the tray.

You can see estimates of time and material resources needed for printing trays using the different printing modes (see “Production Estimates” on page 48). You also see these production estimates when you send the tray to the printer. At that time, you can select the printing mode, including an option that enables Objet Studio to print the tray by the most efficient method (see “Printing-Mode Selection” on page 51).

E-mailing Objet Digital Files

You can easily e-mail *objdf* files using Microsoft® Office Outlook®. Sending *objdf* files is recommended (instead of *stl* files) because the size of a file is typically reduced by more than half. An added benefit is that the *objdf* file contains the model-material information for the object.

To e-mail a file:

1. From the *Tools* menu, select Email Objet Digital File.
Outlook opens with the file attached and *Subject* details added to the e-mail form.
2. Enter the e-mail address and send the file.

Printing the Tray File

When a tray is ready to be printed, it is placed in the Jobs Queue. When the job reaches the head of the queue, Objet Studio pre-processes the tray file to create slices, and feeds them to the 3D printer.

To send the tray to the print queue:

1. On the *Tray Settings* ribbon, *Build Process* group, click  **Build**.
 - If printing the tray requires two model materials (Digital Material mode), the *Job Summary* dialog box opens.

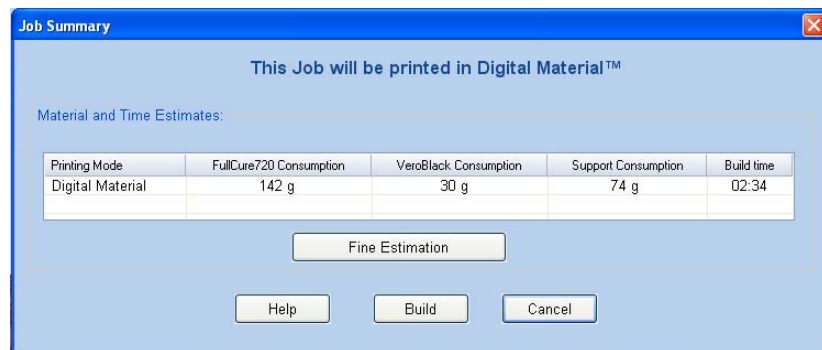

Figure 5-71: Job Summary when printing with multiple model materials

Note:The values displayed are the result of a quick calculation, and represent a rough estimate of the materials and time input required to print the job. For a more accurate calculation, click Fine Estimation.

Continue with step 4 on page 5-52.

- If printing the tray requires only one model material, the *Printing Mode Selection* dialog box opens.

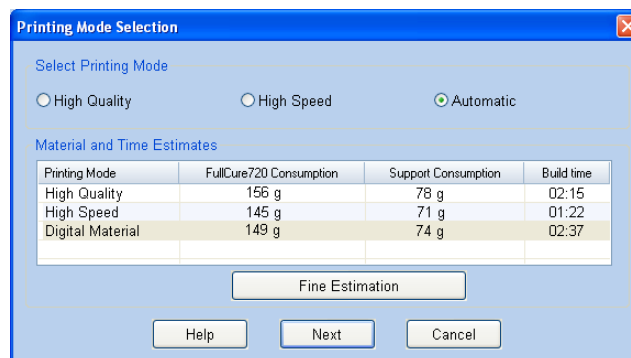

Figure 5-72: *Printing Mode Selection* dialog box

Note:The values displayed are the result of a quick calculation, and represent a rough estimate of the materials and time input required to print the job. For a more accurate calculation, click Fine Estimation.

Printing-Mode Selection

2. Select the appropriate printing mode.
 - If you require the job to be printed in High Quality mode, select this option.

Note:The availability of High Quality mode depends on the material selected.
 - If you require the job to be printed in High Speed mode, select this option.
 - If you do not require the job to be printed either in High Quality or High Speed mode, select Automatic.

This setting enables the Connex software to determine (just before printing) the most efficient way to print the tray. Digital Material mode is used if this removes the need to perform the Material Replacement procedure. Otherwise, High Speed mode is used.

For example, if printing the tray requires only one of the model materials loaded in the printer, only the two print heads using that material are used to print models—Digital Material mode. (High Quality and High Speed modes call for printing model material with four heads, which would require you to perform the Material Replacement procedure.)

On the other hand, if printing the tray can be done using four print heads without running the Material Replacement procedure, High Speed mode is used. This is possible if all print heads are supplied with one model material, or if you allow printing with an arbitrary mixture of similar materials (see below).



Model Quality When Digital Material Mode is Used

- Near-high-quality is achieved for most models.
- If **all** objects on the tray are inserted from **individual stl files**, they are printed with the standard resolution of 600 dpi (dots per inch) along the Y-axis—unless glossy finish is required (see “Surface Finish” on page 24).
- If there is an **assembly** on the tray, all of the models on the tray are printed with a resolution of 300 dpi along the Y-axis.

3. Click Next.

The *Model Material Substitution* dialog box opens—if this is relevant for the tray. (If not, the *Job Summary* dialog box opens—continue with step 4.)

Model Material Substitution

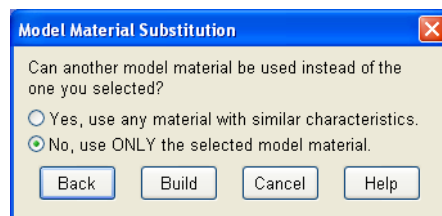

Figure 5-73: *Model Material Substitution* dialog box

If you allow the use of substitute model materials, the printer will use different materials whose characteristics (strength, flexibility, etc.) are similar to those of the material you assigned to the object when designing the build tray—under the following conditions:

- The material you assigned is not installed in the printer at the time of printing.

In this case, the tray is printed with either one or two substitute materials (depending on the materials installed in the printer at the time of printing). If possible, High Speed mode is used.

- In addition to the material you selected, there is another (similar) material installed in the printer at the time of printing.

In this case, High Speed mode is used, by printing with a mixture of the two materials (as if they were the same material).

4. Click **Build**.

If the build tray file has not been saved, the *Save As* dialog box opens for you to save it now.

Objet Studio checks if there is a problem with the positioning of objects on the tray. If so, the affected objects are displayed with special colors (see “Tray Validation” on page 47), and a warning message appears.

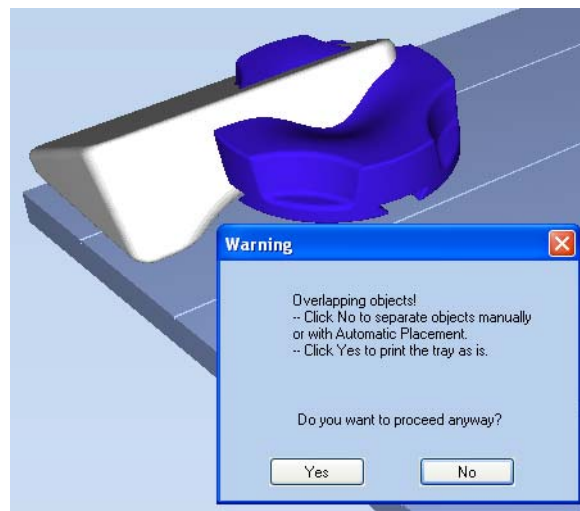

Figure 5-74: Tray validation warning message

- To cancel the *Build* command so you can correct the problem, click **No**.
- To print the models as they are positioned on the tray, click **Yes**.

The *Job Manager* screen opens, so you can monitor the progress of your trays—before, during, and after printing. See “Monitoring and Managing Print Jobs” on page 70.

Applying Additional Objet Studio Features

Dividing Objects

You can use the Split Object feature to produce objects larger than the tray area by dividing the model into separate parts. With this feature, you produce only a specific section of a model.

To split an object:

1. Select the object.
2. From the *Object* menu, select *Split*.
3. In the *Split Object* dialog box, enter the values to determine how Objet Studio will divide the object. You can divide an object along any of its axes, by entering either exact measurements or the number of parts.

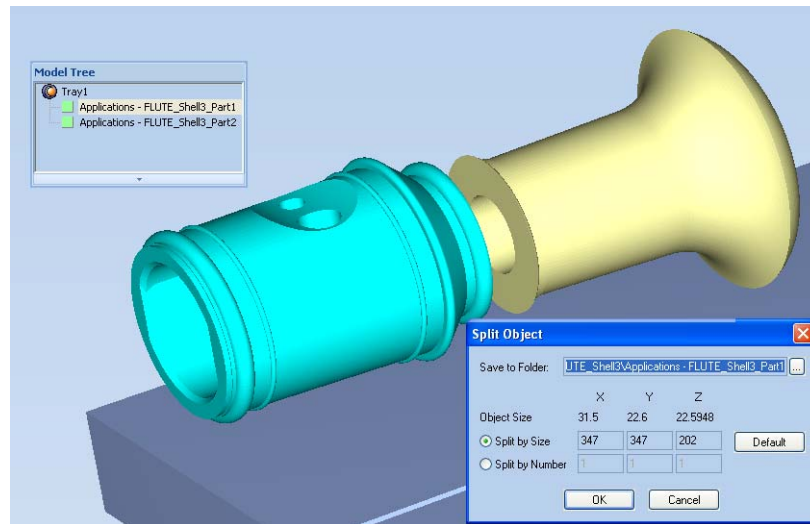

Figure 5-75: *Split Object* dialog box

4. In *Save to Folder*, enter the folder name.
5. Click *OK*.



The composite parts are saved as new *stl* files with “Part 1,” “Part 2,” etc., added to the original file name.

Note: Before printing the newly created *stl* files, it is recommended that you check them for defects in an STL-repair application, such as Magics™, by Materialise®.

Choosing the Support Strength

When producing models, support material fills some hollow and empty sections (see “Model Orientation” on page 28). Objet Studio allows you to adjust the strength of the structure formed with the support material. This adjustment is useful when producing either large/massive models or small/delicate models. For most purposes, the default setting provides adequate support strength.

To change the strength of the support structure used when printing a model:

1. Select a model on the tray.
2. On the *Model Settings* ribbon, in the *Options* group, click .
 - or—
 - On the Model Toolbar, click .
 - or—
 - From the right-click context menu, select Advanced Properties.

The *Advanced Properties* dialog box opens.

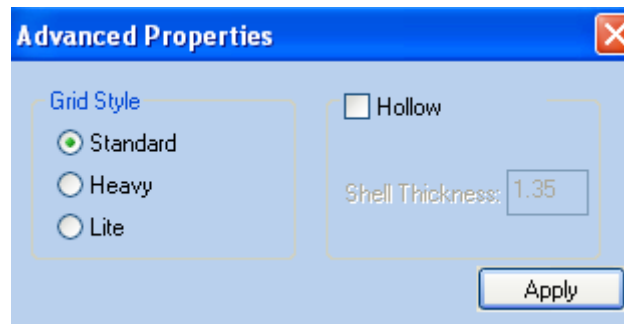

Figure 5-76: *Advanced Properties* dialog box

3. In the *Grid Style* section, choose the support strength suitable for the selected model. You can select a different support strength for each model on the tray.
 - **Standard**—for models needing average support (most models).
 - **Heavy**—for large models needing much support.
 - **Lite**—for delicate models needing little support. (This setting makes it easy to remove the support material.)

Note: If an object is split into shells, the *Advanced Properties* enabled vary with the object selection. If a single element is selected only *Hollow* is enabled. If a group of elements is selected only *Grid Style* is enabled.

4. Click Apply.

“Hollow”— Filling Models with Support Material

Many objects placed on the tray from *stl* files are “solid.” This means that, when printed, the model will be completely filled with model material. Often, especially with large objects, this is unnecessary. Instead, the model can be filled with support material, which is less costly. It is also advisable to fill models with support material when preparing them for investment casting, since this material burns off more quickly during the process of making the cast.

Objet Studio enables you to print objects on the tray with an outer shell of model material and a center filled with support material. When using this feature, called “Hollow,” the thickness of the shell should be no less than 0.5 millimeters.

To use the Hollow feature:

1. Select a model on the tray.
 - or—
 - On the Model Toolbar, click .
 - or—
 - From the right-click context menu, select Advanced Properties.

The *Advanced Properties* dialog box opens.

2. Select Hollow.



Figure 5-77: *Advanced Properties* dialog box

3. Set the shell thickness, in millimeters.
4. Click Apply.

Note: There is no change in the display of objects in Objet Studio when Hollow is selected.

To inspect, change or cancel the Hollow setting:

1. Select a model on the tray.
2. Access the *Advanced Properties* dialog box, as above.
3. If you change or cancel the Hollow setting, click Apply.

Displaying the Cross Section of Objects

The *Section* feature enables you to view the interior of an object by “slicing” it on any axis. You can then manipulate the object to inspect the interior from different angles. This may be important for deciding on the type of support necessary when producing the model (see “Choosing the Support Strength” on page 54). Displaying an object’s cross section only affects how the tray is displayed on the screen; it does not change the object itself.

To display a cross section of the tray:

1. From the *Tools* menu, select *Section*.

The *Section* dialog box opens.

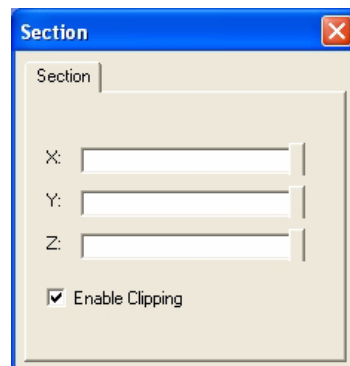

Figure 5-78: *Section* dialog box

2. Select *Enable Clipping*.
3. Use the slider controls for the X-, Y-, and Z-axes to cut the tray so that you see the cross section you want.

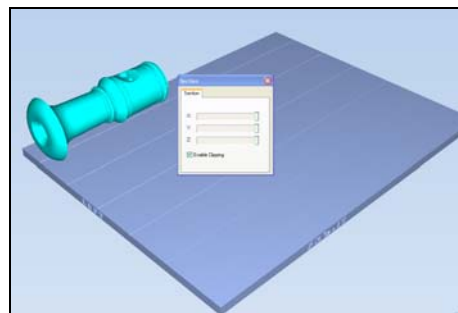

Figure 5-79: Whole view

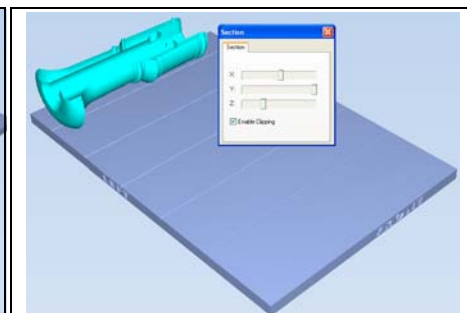

Figure 5-80: Cross-section view, after using the Z-slider

Saving the Screen Display as an Image File

You can save the image displayed in the active viewing screen as a graphic file.

To save the screen display as an image:

1. Press Ctrl+B.

or —

From the Objet Studio Commands menu , select Save Bitmap.

The *Save Bitmap* dialog box opens.

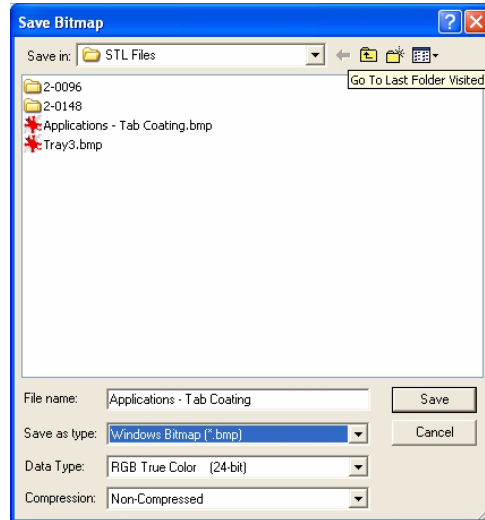

Figure 5-81: *Save Bitmap* dialog box

2. At the top of the dialog box, select the appropriate folder.
3. At the bottom of the dialog box, enter a file name.
4. Open the *Save as type* drop-down list, and select the file format.
5. Click Save.

Exporting and Importing Objet Build Trays

When you save build trays in Objet Studio, they are saved as *objtf* files. These files contain instructions to Objet Studio and to Connex printers for displaying and producing the *stl* files used on the tray. To conveniently save all of the files as they are positioned on the build tray, for storing the job, or for transferring it to another location, Objet Studio compresses them into one *objzf* file. To later use the *objzf* file, the file must first be expanded in Objet Studio and its component files saved.

Note: If you export an *objzf* file containing a *stl* file originally saved as read-only, you cannot open (import) this *objzf* file to the folder where the read-only *stl* file is saved.

To create an *objzf* file:

1. From the Objet Studio Commands menu , select Export Packed Job. The *Save As* dialog box opens.
2. Select the appropriate folder and change the file name (if necessary).
3. Click Save.

To open an *objzf* file:

➤ Double-click on the *objtf* file.

or—

1. From the Objet Studio Commands menu , select Import Packed Job.
2. In the *Open* dialog box, display the appropriate folder and select the file.
3. In the *Browse for Folder* dialog box, display the folder in which you want Objet Studio to expand the compressed file, and click OK.

The *objtf* file and associated *stl* files are expanded and placed in the selected folder, and the tray is displayed in Objet Studio.

Note: You can also export a print job as an *objzf* file from the *Job Manager* screen—see “Exporting Jobs (*objzf*)” on page 82.

Customizing Objet Studio

You can customize Objet Studio to suit your particular working needs and preferences. Features that you can customize include:

- Creating a quick-access toolbar for frequently used commands.
- Changing the position of the Quick Access toolbar.
- Minimizing the ribbon.
- Changing the Objet Studio color theme.
- Configuring default settings for objects placed on the build tray.

Creating a Quick Access Toolbar

As you work with Objet Studio, you may use certain commands frequently. You can create a quick-access toolbar to make your work easier.

To create a quick-access toolbar:

1. Above the ribbon tabs, click .

The *Customize Quick Access Toolbar* menu opens.

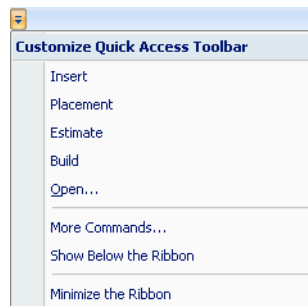

Figure 5-82: *Customize Quick Access Toolbar* menu

2. Select a command you want to add to the toolbar.

An icon for the selected command is added to the toolbar.

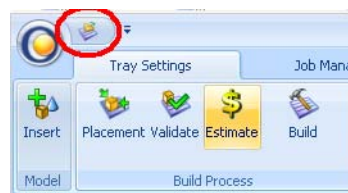



Figure 5-83: Quick Access toolbar

To add another command, repeat the above procedure.

3. To choose from a wider range of commands:
 - From the *Customize Quick Access Toolbar* menu (see figure 5-82 on page 59), select *More Commands*.
- or—
- Right-click on the Objet Studio Commands icon , or elsewhere on the ribbon, and select *Customize Quick Access Toolbar*.

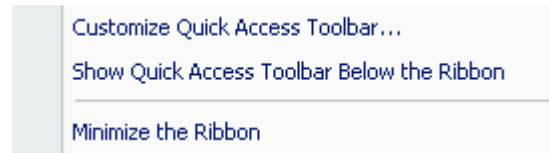
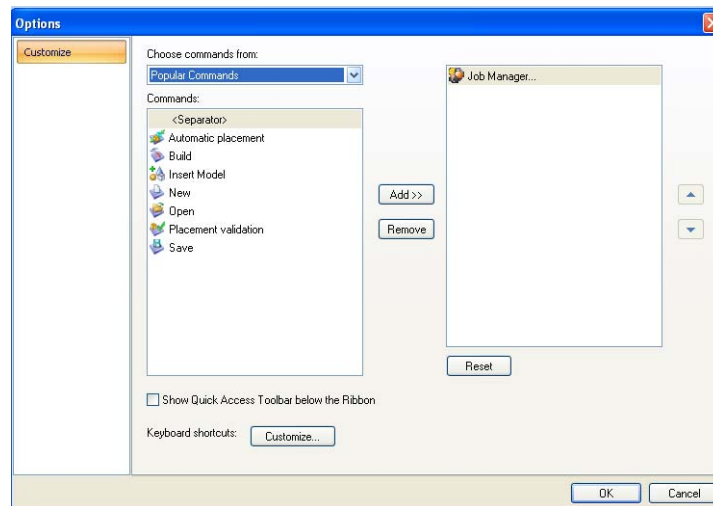

Figure 5-84: Right-click ribbon menu

The *Options* dialog box opens.

Figure 5-85: Quick Access Toolbar *Options* dialog box

4. Open the drop-down list and select either *Popular Commands* or *Commands not on the Ribbon*.
5. Select a command and click *Add*.
6. Click *OK*.

Hiding the Ribbon

To make more room for displaying the build tray, you can hide the Objet Studio ribbons.

To hide the ribbons:

1. Right-click anywhere on the ribbon or on the menu bar, or in the Objet Studio Commands menu .
2. Select *Minimize the Ribbon*.

The ribbons disappear, but you can temporarily display the ribbon icons by clicking *Tray Settings* or *Job Manager* on the menu bar. When you next click outside of the ribbon, it disappears again.

To return the permanent ribbon display:

- Repeat the steps above to cancel *Minimize the Ribbon*.

Display Colors You can customize some of the colors used for displaying Objet Studio screens and for displaying objects on the build tray.

To change the colors used in Objet Studio screens:

1. From the *Tools* menu, select *Options*.

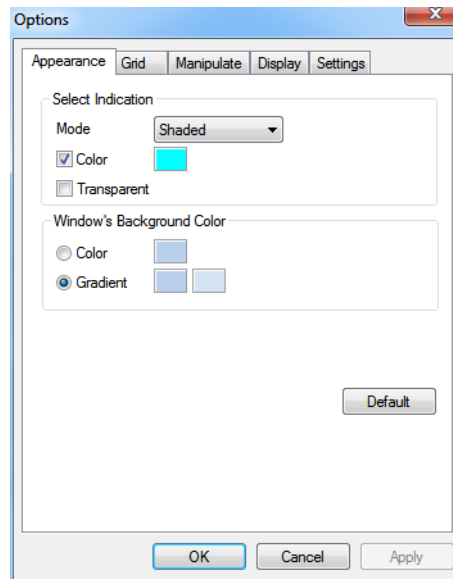

Figure 5-86: Display settings

2. In the *Appearance* tab of the *Options* dialog box, you can configure the display.
 - The *Mode* selection determines how models appear on the build tray. The default method for displaying models on the build tray is as solid (“shaded”) objects. The other options are *WireFrame* and *Points*.
 - If *Shaded* is selected, you can display the model on the tray as a see-through object.

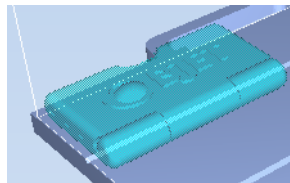

Figure 5-87: Transparent display

- Double-click the color patches to customize colors.
- The *Windows Background Color* settings enable you to change the color behind the build tray — with either a solid or a two-color gradient.
- To return to the default display settings, click *Default*.

Changing Color Themes Objet Studio offers a choice of four background color themes—blue, black, silver and aqua.

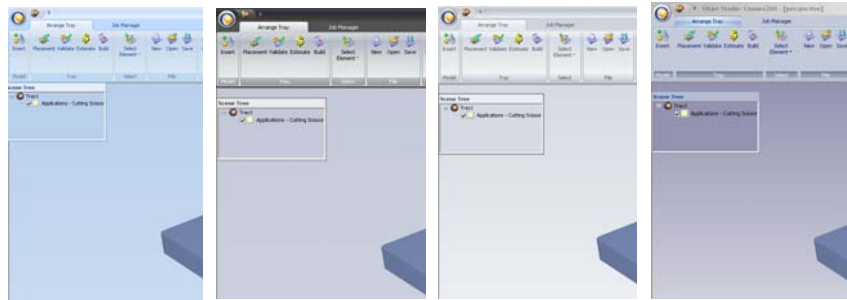

Figure 5-88: Background color themes

To change the color theme:

- From the *Style* menu, select one of the options.

Keyboard Shortcuts

You can define shortcut keys for frequently used commands.

To define shortcut keys:

1. Above the ribbon tabs, click .

The *Customize Quick Access Toolbar* menu opens.

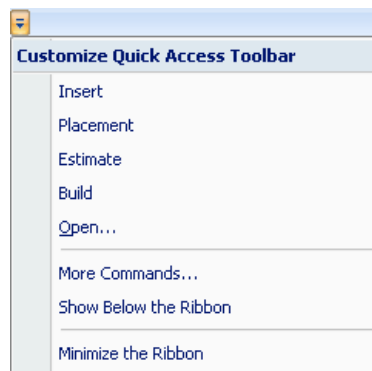

Figure 5-89: *Customize Quick Access Toolbar* menu

2. Select *More Commands*.

The *Options* dialog box opens (see figure 5-85 on page 60).

3. Click **Customize**.

The *Customize Keyboard* dialog box appears.

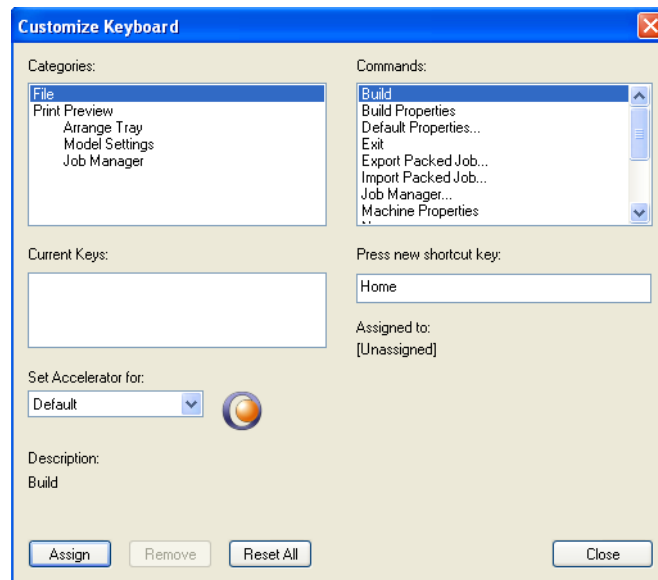

Figure 5-90: *Customize Keyboard* dialog box

4. Select command *Categories* to display all the commands in that category, for example, all the *Model Settings* commands.
Current shortcut keys are displayed.
5. Enter the shortcut key in the *Press new shortcut key* field, and click **Assign**.
6. If you want to redefine all shortcut keys, click **Reset All**.

Setting User Preferences

You can change several Objet Studio settings that affect objects placed on the build tray.

To change default settings:

- From the **Objet Studio Commands** menu , select **User Preferences**.

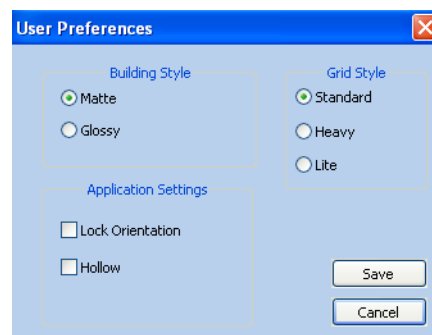

Figure 5-91: Setting work preferences

- **Building Style**—see “Surface Finish” on page 24.
- **Grid Style**—see “Using a Grid to Position Objects” on page 31.
- **Application Settings**—see “Choosing the Support Strength” on page 54, and “Freezing Model Orientation” on page 38.

Professional Mode Features

Some advanced features of Objet Studio are only accessible in *Professional Mode*.

To see the current Objet Studio setting:

- Open the *Tools* menu.

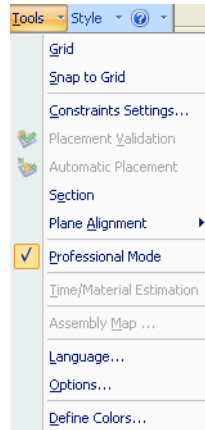

Figure 5-92: *Tools* menu, showing *Professional Mode* selected

If *Professional Mode* is selected, advanced features are displayed.

To change the *Professional Mode* setting:

1. From the *Tools* menu, select *Professional Mode*.

The following message is displayed, reminding you that the change will only take effect the *next time* you open Objet Studio—even though the check mark next to the *Professional Mode* option appears immediately.

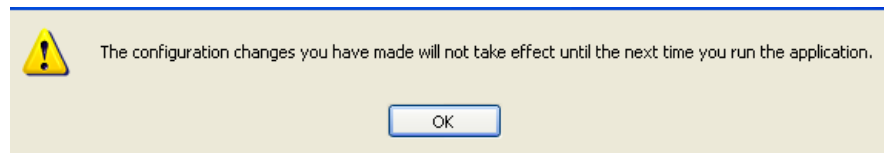

Figure 5-93: Configuration-change message

2. Close and re-open Objet Studio to use the *Professional Mode* features.

Default Settings

You can control the default settings of several Objet Studio features from the *Advanced* tab of the *Options* dialog box.

To display the Options dialog box

- From the *Tools* menu, select *Options*.

or —

In the Objet Studio Commands menu , click *Options*.

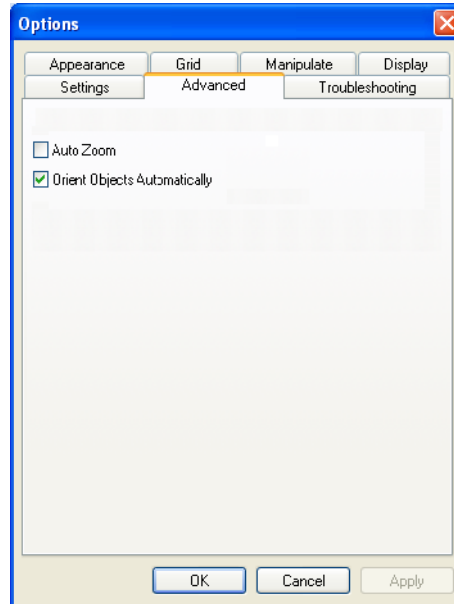

Figure 5-94: *Options* dialog box, *Advanced* tab

Automatic Orientation By default, when Objet Studio places objects on the build tray, it orients them optimally, for the shortest printing time. If necessary, you can choose to cancel automatic orientation each time you place an object on the build tray (see “Automatic Orientation” on page 26). In any case, when objects are on the build tray, you can change their orientation manually (see “Model Orientation” on page 28.)

To change the default setting so that *Automatic Orientation* is disabled:

- In the *Advanced* section of the *Options* dialog box, clear the check box.

Automatic Zoom When *Auto Zoom* is selected in the *Advanced* section of the *Options* dialog box, the display zooms in, to display the objects placed on the build tray. This allows you to carefully inspect and manipulate the objects.

By default, this feature is **not** enabled. In any case, you can change the zoom level, as necessary (see “Zoom Options” on page 46).

OpenGL Driver Configuration

The OpenGL driver displays 3D graphics on your screen. There is normally no reason to adjust its settings. If you suspect a problem with the way Objet Studio displays objects, you can use the OpenGL Driver Configuration tool to check and configure the driver settings.

To access the *OpenGL Driver Configuration* dialog box:

1. From the *Tools* menu, select *Options*.
or—
In the Objet Studio Commands menu , click *Options*.
2. In the *Options* dialog box, display the *Troubleshooting* tab.

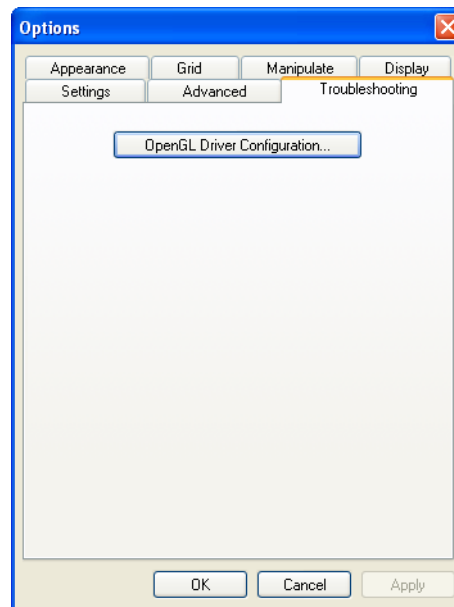

Figure 5-95: Access to OpenGL Driver configuration



The Troubleshooting tab is only accessible when Professional Mode is active (see “Professional Mode Features” on page 64).

3. Click *OpenGL Driver Configuration*.

The dialog box that opens displays details of the pixel format ID (index) for the window and the memory.

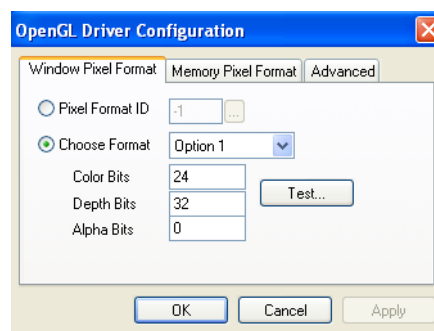



Figure 5-96: *OpenGL Driver Configuration* dialog box

If you want to display the values and change them, click . Alternately, you can select *Choose Format* and change the values in this dialog box.

To perform a test of the driver configuration and enter the suggested pixel format ID:

1. Select Choose Format.
2. Click Test.

Objet Studio returns the recommended pixel format ID.



Figure 5-97: Recommended pixel format ID

3. Click OK.
4. In the *OpenGL Driver Configuration* dialog box (figure 5-96), select Pixel Format ID and enter this number.
5. Click Apply.
6. Display the other pixel format tab, and repeat this procedure.

Getting Additional Objet Studio Assistance

Objet Studio Help provides on-screen instructions and information, as you work.

To view Objet Studio Help:

- On the standard toolbar, click  and then click Objet Studio Help.

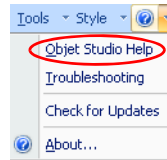

Figure 5-98: Help options

You can also view information on the following subjects:

- *Troubleshooting* opens a list of error messages and their explanations.
- *Check for Updates* checks if you are using the latest Objet Studio version.

Objet Studio Version, Material Module and Licensed Features

You can view details of the Objet Studio version, the material module installed, and the features available with your license.

To view details of your Objet Studio installation:

- On the standard toolbar, click  and then click About....

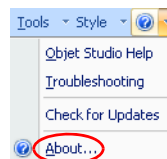

Figure 5-99: Displaying Objet Studio details

About Objet Studio
tab

The *About Objet Studio* tab shows the Objet Studio version number and basic information about your computer.

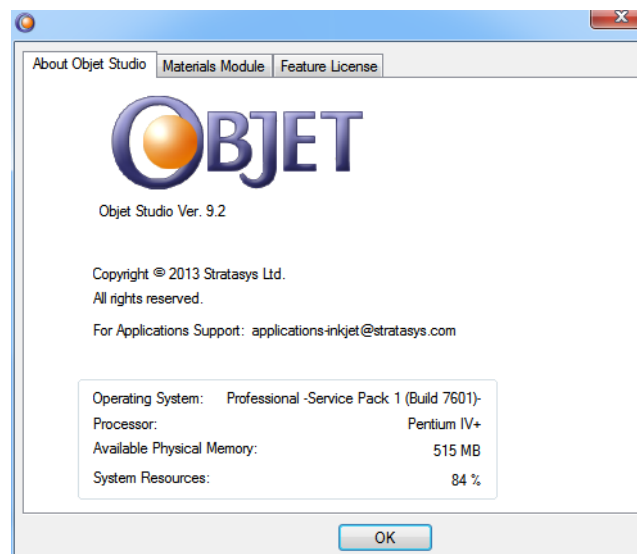

Figure 5-100: About Objet Studio tab

Materials Module tab The *Materials Module* tab shows details of the material module installed.

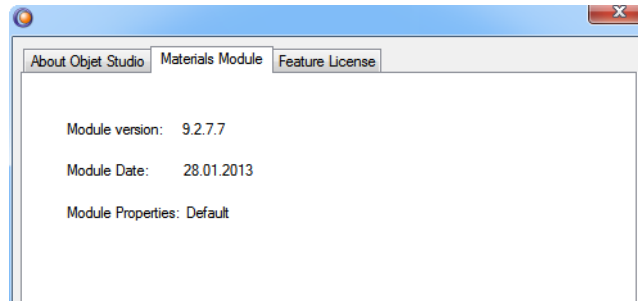

Figure 5-101: Materials Module tab

- *Module version*

If a Materials Module upgrade (patch) was installed, the new Materials Module version is displayed. If no patches were installed, the *Module version* is the same as the Objet Studio version.

- *Module date*

If a Materials Module upgrade (patch) was installed, the date of its creation is displayed. If no patches were installed, the *Module date* is the date of the Objet Studio version.

- *Module properties*

If a Materials Module upgrade (patch) was installed, its description is displayed. If no patches were installed, “Default” is displayed.

Feature License tab The *Feature License* tab shows the Objet Studio features available with your license.

Figure 5-102: Feature License tab

Click  to expand the details for each feature.

- *Modes* shows the printing modes available.

See “Printing Modes” on page 49.

- *Materials* shows basic model materials available.

- *Digital Materials* shows the digital materials available.

- *Mixed Tray* shows if your license enables printing a build tray containing objects, using a different model material for each.

Monitoring and Managing Print Jobs

In the *Job Manager* screen of Objet Studio, you monitor and manage jobs sent to the printer. There are a few differences between Objet Studio on client workstations and on the computer connected directly to the 3D printer—the server workstation.

- Objet Studio installed on a client computer only displays the queue and status for jobs sent to the 3D printer server from that computer, and it allows the user to edit only these jobs.

Note: If there are several Objet printers on the local network, client computers can connect to any of them, but only one at a time.

- Objet Studio installed on the computer directly connected to a specific 3D printer (server), displays the queue and status for all jobs sent to that 3D printer by the server and by all client computers on the network. It also allows editing and manipulation of all jobs, and enables re-sending previously-printed jobs to the printer.



If Objet Studio is not connected to a printer (or printer server), you can prepare tray files for any Objet printer. Later, these files can be used by Objet Studio on the appropriate printer server.

Job Manager Screen

The *Job Manager* screen on the client and server workstations looks identical. The only difference is that options only relevant to the server workstation are disabled for client installations.

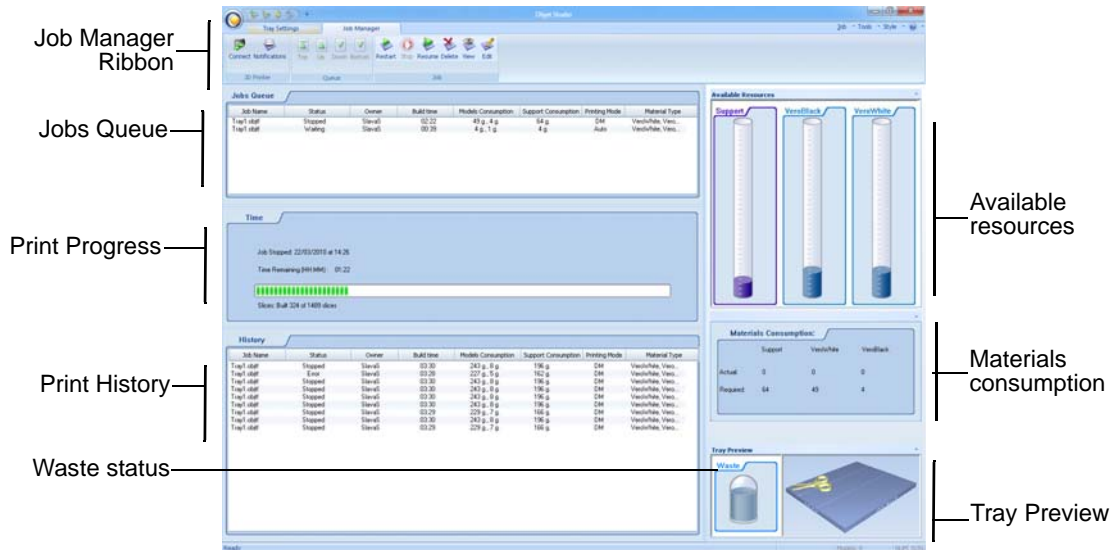

Figure 5-103: *Job Manager* screen

The *Job Manager* screen is divided into panels:

- Jobs Queue
- Printing Progress
- History
- Available Resources
- Material Consumption
- Tray Preview
- Waste

Jobs Queue On the server, the *Jobs Queue* lists the last 15 jobs sent from client computers. On client workstations, the *Jobs Queue* lists jobs sent from that computer to the printer server.

Information for each of the queued jobs is displayed, including the job status.

Status	Meaning
Waiting	Printing of this job has not started.
Building	Printing of this job is in progress.
Stopped	Printing of this job was interrupted. Printing can later be continued (<i>Resume</i>) or begun again (<i>Restart</i>).
Error	Errors occurred during the printing of this job, and it was placed in the Jobs Queue again.
Editing	This job is now being edited in Objet Studio.
Spooling	The job file is being spooled in the printer.
Preprocessing	The 3D printer is readying itself for printing: the cover locks, print heads warm up and are put in starting position, UV lamps are turned on, and the build tray level is adjusted.
On Schedule	The job is scheduled to be printed at a specified time.

In addition, the following information is displayed:

- *Owner*—the computer that sent the job
- *Build Time*—the estimated building time for the job
- *Model Consumption*—the amount of model material required to complete the job, and the amount actually used till now
- *Support Consumption*—the amount of support material required to complete the job, and the amount actually used till now
- *Printing Mode*—HS=High Speed, HQ=High Quality, DM=Digital Material

Printing Progress The *Time* panel shows printing times and the number of slices sent to the printer.

History The *History* panel shows information for the last 50 jobs and their final status. You can drag a job from *History* to *Jobs Queue* to print the tray again.

Available Resources The *Available Resources* panel contains graphic indicators that show the amount of available printing materials remaining in the printer.*

Material Consumption

- *Actual*—the amount of material used till now
- *Required*—the amount of material still needed to finish the job

Tray Preview The *Tray Preview* panel displays the build tray view of the job selected in the *Job Queue* or the *History* list.

On a server, you can open an enlarged preview window by clicking on the *Tray Preview* display (see “Extended Tray Preview” on page 80).

Waste If you move the mouse over the *Waste* display, the amount of waste in the container is displayed.

* Objet Studio displays the weight of the printing materials in both cartridges as long as each cartridge contains more than 100 grams of material. The weight under 100 grams is not calculated and displayed. However, if a cartridge contains less than 100 grams of material, the printer uses it—as long as the material in the other cartridge weighs more than 100 grams. In any case, the weight of each cartridge is displayed in the printer application.

Setting the Printer Connection

When an Objet 3D printer is installed, the server computer is connected to that printer. Normally, there should be no reason to change this connection. Occasionally, however, you may need to reset the connection, to connect the server to another printer, or to use Objet Studio in off-line mode (without a printer connection).

To set (or change) the printer connection:

1. On the *Job Manager* ribbon, in the *3D Printer* group, click .
2. In the *Set Printer* dialog box, click **Connect**.

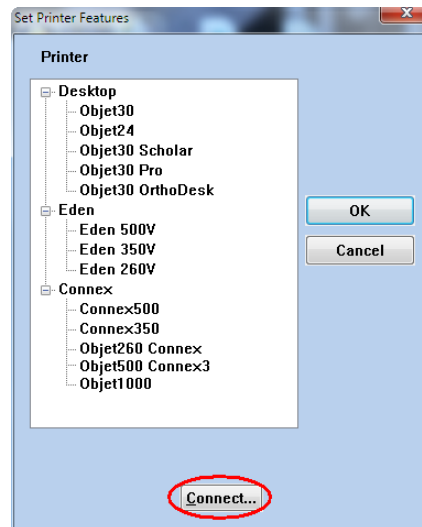

Figure 5-104: Connecting to a printer (A)

3. Enter the computer name or its IP address, or click **Browse** to find and select it.

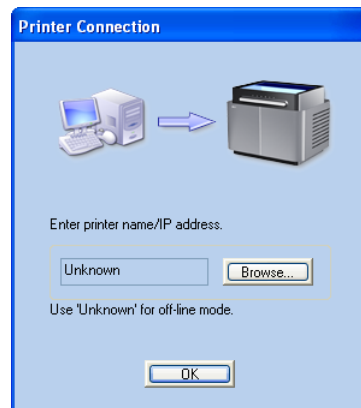

Figure 5-105: Connecting to a printer (B)

4. Click **OK**.

When the connection is established, Objet Studio is configured to prepare print jobs for that printer.



If you can see the material levels in the *Job Manager* screen (see figure 5-103 on page 70), Objet Studio is connected to the printer.

Off-line Mode

You can use Objet Studio to prepare trays for printing in off-line mode, on a remote computer or when the printer connection is not available. You also use off-line mode to prepare trays for printing with other printers. In this case, if Objet Studio is currently connected to a printer, you must change to off-line mode by removing this connection.

To disconnect Objet Studio from the printer:

1. On the *Job Manager* ribbon, in the *3D Printer* group, click .
2. In the *Set Printer* dialog box, click *Connect* (see figure 5-104).

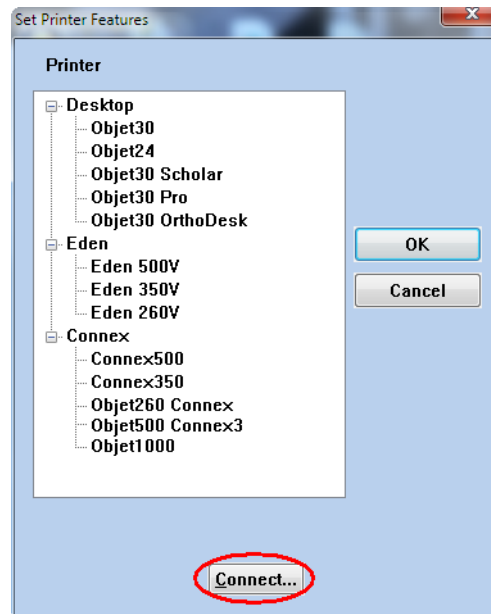

Figure 5-106: Disconnecting Objet Studio from a printer (A)

3. In the *Printer Connection* dialog box, delete the computer name/IP address.

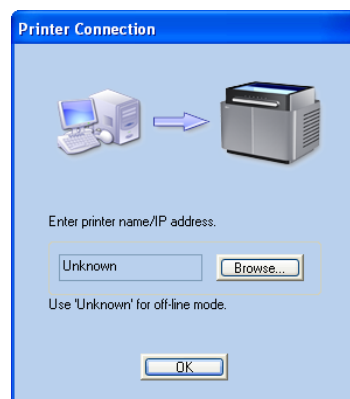

Figure 5-107: Disconnecting Objet Studio from a printer (B)

4. Click *OK*.
 5. Click *OK*.
- “Unknown” appears in the printer-name field.

6. In the pop-up message, confirm that you want to work in off-line mode by clicking No.

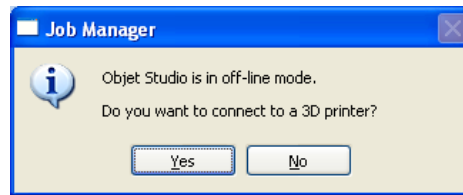

Figure 5-108: Off-line message

When Objet Studio is in off-line mode, you can configure it for preparing print jobs for different printers.

To change the Objet Studio off-line configuration:

1. In the *Set Printer* dialog box, select a printer type.

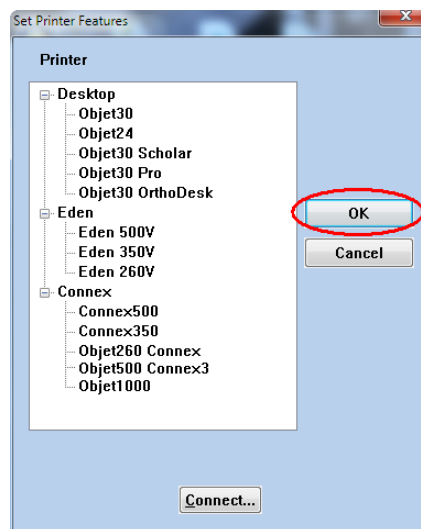



Figure 5-109: Off-line printer selection

2. Click OK (*not* "Connect").

Setting the Remote Printer Connection (Client Mode)

When you open Objet Studio for the first time in a client installation, you are prompted to connect to an Objet server computer that sends jobs to a 3D printer. To do this, the server computer must be operating and connected to the local network.

To set (or change) the connection to the server-computer:

1. On the *Job Manager* ribbon, in the *3D Printer* group, click .
2. Enter the name of the server computer or its IP address, or click **Browse** to find and select it.
3. Click **OK**.

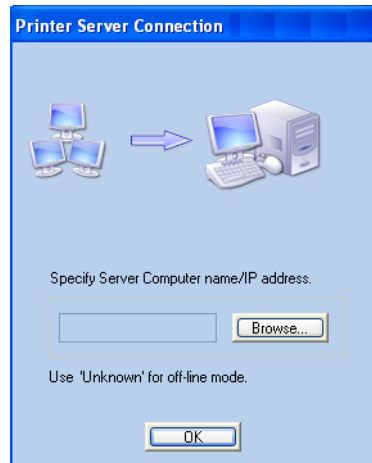

Figure 5-110: *Printer Server Connection* dialog box

Job Manager Commands

The *Job Manager* ribbon has three icon groups:













- 3D Printer
- Queue
- Job



Figure 5-111: *Job Manager* ribbon commands

Icons are enabled or disabled according to their relevancy. For example, since you cannot stop printing a job that is not being printed, the *Stop* command is disabled when the printer is idle.

The following operations are available on the *Job Manager* ribbon:

Group	Icon	Purpose
3D Printer		Client: Sets the server connection. See “Setting the Remote Printer Connection (Client Mode)” on page 75. Server: Sets the printer connection. See “Setting the Printer Connection” on page 72.
		Configures options for printer alerts. See “Configuring User Alerts” on page 78.
Queue		Server: Moves a job to the head of the Jobs Queue. Client: Disabled. See “Jobs Queue” on page 71.
		Server: Moves a job to a higher position in the <i>Jobs Queue</i> . Client: Disabled. See “Jobs Queue” on page 71.
		Server: Moves a job to the bottom of the <i>Jobs Queue</i> . Client: Disabled. See “Jobs Queue” on page 71.
		Server: Moves a job to a lower position in the <i>Jobs Queue</i> . Client: Disabled. See “Jobs Queue” on page 71.
		Server: <ul style="list-style-type: none"> For a job in the <i>Jobs Queue</i>—Prints it again (from the beginning). For a job in the <i>History</i> list—Moves it to the <i>Jobs Queue</i> for printing. Client: Disabled. See “Restarting Jobs” on page 81.
	Server: Stops a job in progress. Client: Disabled.	
	Server: Continues printing the current job from the point where printing stopped. Client: Disabled. See “Resuming Jobs” on page 81.	
	Removes the selected job from the queue.	
	Refreshes the image of the selected job in the <i>Tray Preview</i> display.	
	Opens the <i>Tray Settings</i> screen and displays the tray. For deleted jobs, this enables you to make changes before printing.	

In addition to using ribbon command icons, you can use commands on context (pop-up) toolbars and from the *Job* menu on the standard toolbar.

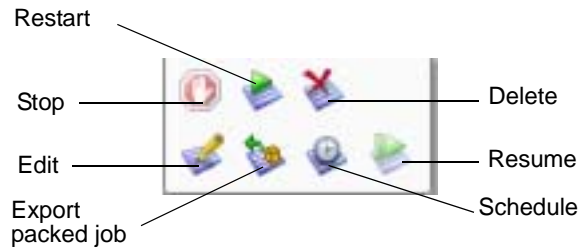

Figure 5-112: Icons on pop-up toolbar (server)



Figure 5-113: Icons on pop-up toolbar (client workstation)

Note: Most icons and menu commands are only enabled when a job is selected.



When you position the cursor over an item, a tooltip displays the name of the command.

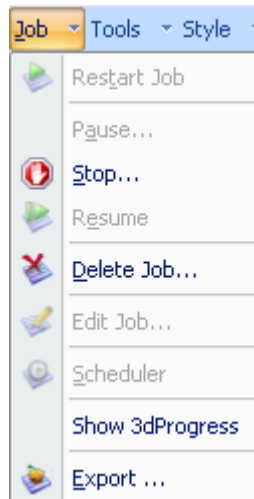

Figure 5-114: *Job* menu options (server)

Configuring User Alerts

Objet Studio can alert you (and others) to the status of jobs sent to the server for printing. This is especially useful during long printing jobs, when the operator is away from the printer. The following events can be reported:

- The level of model or support material is low.
- The job was interrupted.
- The job was completed successfully.

To send e-mail and SMS alerts, make sure that e-mail software supporting MAPI is installed on the server computer. To send SMS alerts, the cellular phone service must support the transmission of e-mail messages by SMS. Only the subject line of the e-mail message is transmitted by SMS.

To configure Objet Studio to send notifications and alerts:

1. On the *Job Manager* ribbon, in the *3D Printer* group, click  .

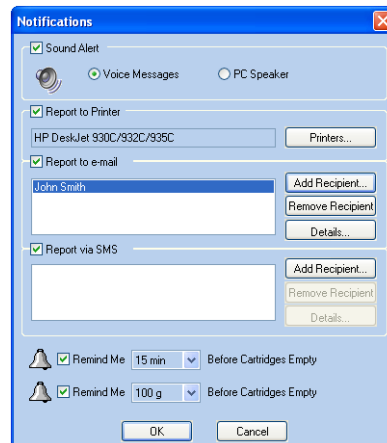

Figure 5-115: *Notifications* dialog box (server)

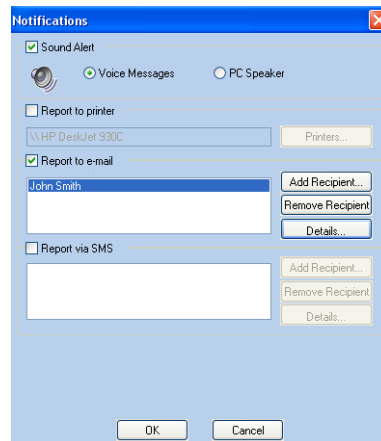

Figure 5-116: *Notifications* dialog box (client workstation)

2. Set the desired reporting options.

3. Click Details.

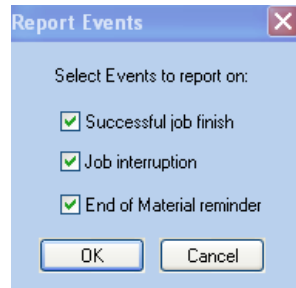

Figure 5-117: Event selection for alerts

4. In the *Reports Events* dialog box, select the alert events and click OK.

5. In the *Notifications* dialog box, click OK.

Printing the Tray

If there is a job in the Jobs Queue, it is sent automatically to the Connex printer—as long as it is on, there is a connection to the printer, and the printer is on line. Chapter 6 describes starting and operating the printer.

Additional Server Features

Objet Studio on the printer server includes the following additional features:

- Extended Tray Preview
- Editing Jobs
- Restarting Jobs
- Resuming Jobs
- Scheduling Jobs
- Exporting Jobs (objzf)
- Modifying the Job Manager Screen

These features are described on the following pages.

Extended Tray Preview

In this window, you can view the tray from different angles and magnifications without leaving the *Job Manager* screen. In addition to displaying the selected job in the *Tray Preview* pane, you can open an enlarged build tray window.

To display the build tray window:

1. Select a job in the *Jobs Queue* or the *History* list.
2. Click the *Tray Preview* pane.

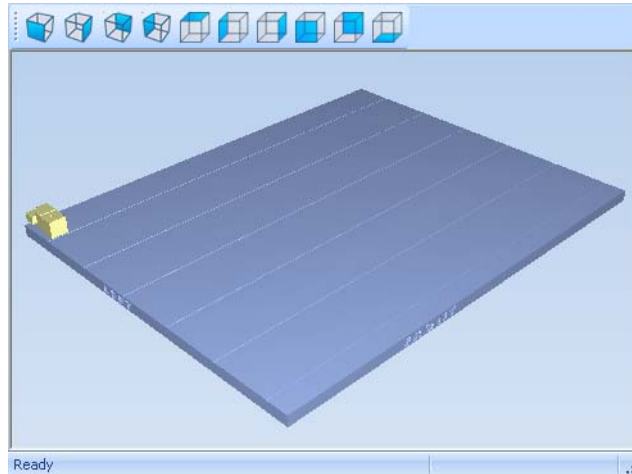

Figure 5-118: Job Preview

- To change the tray magnification, turn the mouse wheel.
- To view the tray from a different perspective, click the relevant icon.
- To resize the window, drag its edge or corners.

If there are several objects on the build tray, you can exclude one or more from being printed, without actually deleting the object from the tray file.

To prevent the printing of an object on the build tray:

1. Double-click on the object you do **not** want to print.
2. Display the *Build* tab.
3. Select *Exclude from Build*.

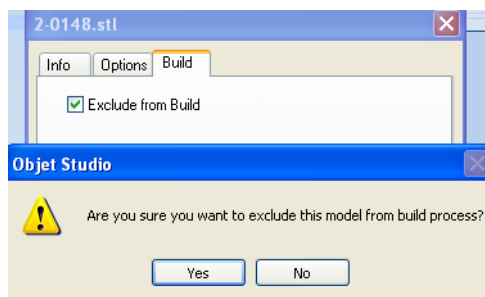

Figure 5-119: Excluding a model from the build

4. Click *Yes* to confirm.

On server computers, you can use Tray Preview to dynamically display objects as they are printed, layer by layer. This enables you to visually monitor printing progress on the computer screen.

To display printing progress in the Tray Preview pane:

- From the *Job* menu, select Show 3dProgress.



This option uses additional system resources.

Editing Jobs

You can open jobs in the *Jobs Queue* for editing.

To edit a job:

1. Select the job.
2. Click the *Edit* icon .

The *Tray Settings* screen opens, displaying the build tray. The status of the job in the *Job Manager* screen changes to “Editing.”

3. Edit the job.
4. On the *Tray Settings* ribbon, click .

The status of the job in the *Job Manager* screen changes back to “Waiting.”

Restarting Jobs

You can restart jobs from the *Jobs Queue* and the *History* list.

To restart a job:

1. Select the job.
2. Click the *Restart* icon .

The job status changes to “Waiting” (in the *Jobs Queue*).

Resuming Jobs

If the printing process is stopped or interrupted, you may be able to continue printing the job from the point where printing stopped.

To resume a job:

1. Select the job.
2. Click the *Resume* icon .

Scheduling Jobs

You can schedule jobs to be printed at a future time. For example, you can configure Objet Studio to start long printing jobs in the late evening and early morning hours.

To schedule a job:

1. Select a job in the *Jobs Queue*, and click  on the pop-up toolbar.
2. In the *Scheduler* dialog box, set the Start Date and Start Time for the job. Click on the *Start Date* arrow to open a calendar.

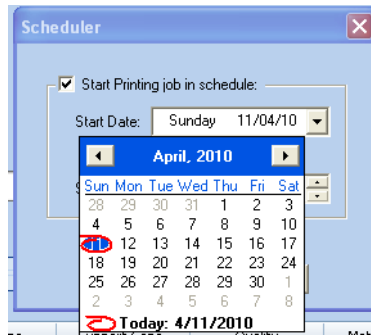

Figure 5-120: Scheduler with calendar displayed

3. Click OK.

Exporting Jobs (*objzf*)

You can save print jobs as compressed files.



For an explanation of *objzf* files, see “Exporting and Importing Objet Build Trays” on page 58.

To export a print job:

1. Select a job.
2. On the pop-up toolbar, click .
3. In the *Save As* dialog box, select a folder.
4. Click *Save*.

Modifying the Job Manager Screen

You can change the size of the sections of the *Job Manager* screen, by dragging the panel edges. This applies to:

- the *Jobs Queue* panel
- the *Time* panel
- the *History* panel

Similarly, you can change the way the screen area is divided between the main section (*Jobs Queue/Time/History*) and the panels on the right side of the screen.

You can collapse (hide) the right panels (*Available Resources/Material Consumption/Tray View*) by clicking the top of the panel.

- Click again to display the panel.

Operating & Maintaining the Connex500/350 3D Printer

Starting the Connex Printer	2
Loading Model and Support Cartridges.....	4
Producing Models	5
Preparing the Printer	5
Printer Interface Color Key.....	7
Printing Indicators	8
Resuming Production After Printing has Stopped.....	9
Changing the Printing Material	11
Keeping the Printer in Idle Mode	16
Shutting Down the Printer.....	17
Maintaining the Printer	19
Routine Maintenance Schedule.....	19
Cleaning the Print Heads and the Roller.....	22
Cleaning and Replacing the Wiper.....	25
Pattern Test.....	27
Improving Print Quality	28
Replacing the Roller Scraper	32
Aligning the Print Heads	34
Calibrating (Optimizing) Print Heads	38
Replacing Print Heads.....	40
Testing and Calibrating the UV Lamps	50
Calibrating the Load Cells	56
Replacing the Odor Filter.....	58
Replacing the UV Lamps	58
Built-in Tests.....	63
Replacing the Waste Container	68
Cleaning the Exterior Panels	70

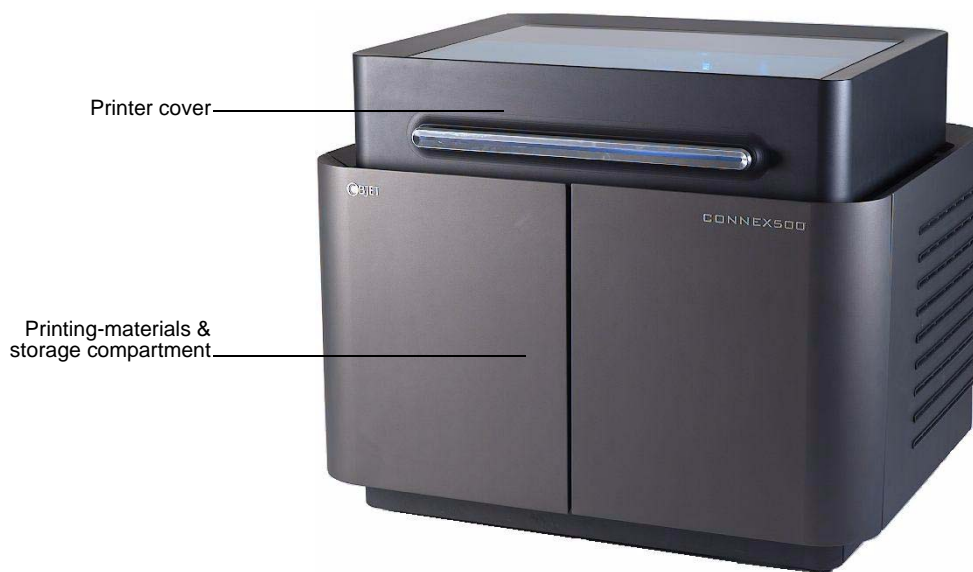

Figure 6-1: The Connex500 3D Printer

Starting the Connex Printer



CAUTION!

- Do not attempt to operate the Connex printer before being trained by a Stratasys customer-support representative.
- Observe all safety warnings and follow the safety guidelines described in chapter 2.

1. Turn on the main power switch, located at the back of the printer.



Figure 6-2: Main power switch and cable

The main power switch turns on the Connex printer, which includes — the built-in computer.

2. After the printer-control computer boots, log in to Windows and launch the printer-control program:
 - On the printer-computer desktop, double-click the Connex printer icon.

OR—

 - From the *Start* menu, select (All) Programs > Objet > Connex500/350.



A HASP plug containing a valid product activation key is required on the printer computer. This is installed at the factory or during printer upgrade. If the application does not open and a HASP message appears, contact your dealer or Stratasys Customer Support.

The Connex printer interface screen opens (see figure 6-3). All monitoring and controlling of the printer is done from this interface.

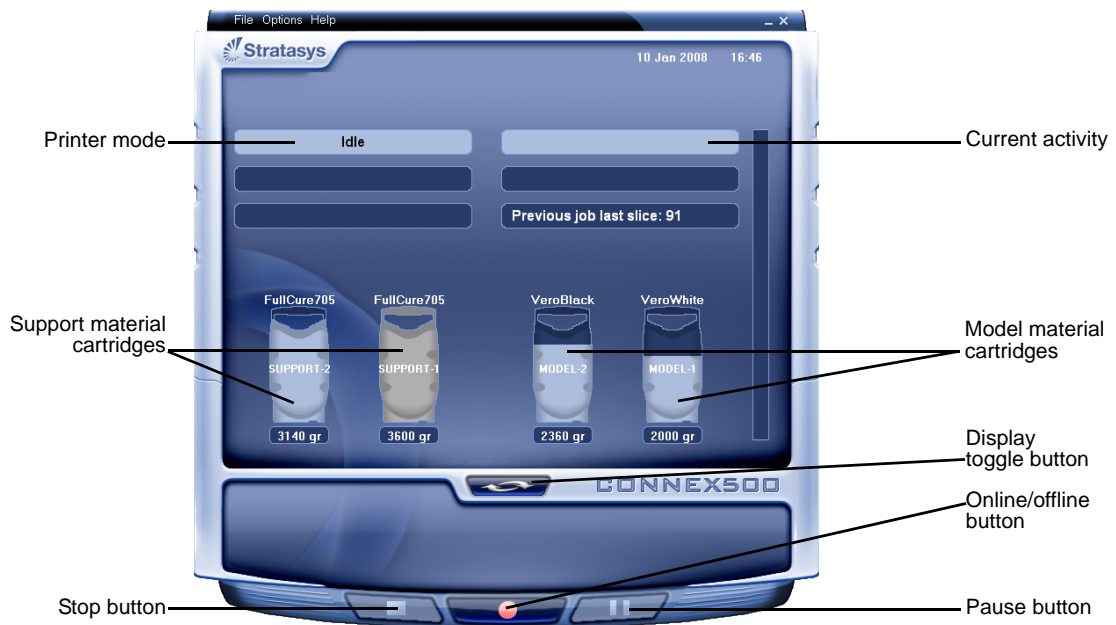

Figure 6-3: Connex500 interface



Connex installations use one monitor for displaying both the computer running Objet Studio and the computer installed inside the printer. Make sure that the KVM (keyboard-video-mouse) switch is in the correct position so that the printer interface is displayed.

Loading Model and Support Cartridges

Connex printers use two cartridges of Model material and two cartridges of Support material, each weighing 3.6 kilograms when full. A graphical representation of the cartridges loaded and their current weight appears in the printer interface (see figure 6-3).



The printer uses RFID technology to automatically identify cartridges of printing material. For this purpose, an RFID module is part of the printer hardware. Tampering with this module will render the printer inoperable and may void Stratasys warranties and service contracts.

Important: If you need to replace the Model material currently installed with another type, see “Changing the Printing Material” on page 11. Otherwise, make sure to replace the Model cartridge with one containing the same type of material.

To load Model and Support material:

1. On the front of the printer (see figure 6-1), pull open the doors of the storage compartment.
2. If you are replacing a cartridge, grasp its handle and pull the cartridge out, taking care not to twist or turn it.
3. Load Model and Support cartridges into their respective compartments—the Model cartridge on the right, and the Support cartridge on the left. (Note that the cartridges only fit into their correct compartments.)

You should feel some resistance, as a needle pierces the cartridge.

4. Check the printer interface to make sure that the new cartridge is detected and that its weight is displayed (see figure 6-3).
5. Close the storage-compartment door.

Tips about loading and replacing material cartridges:

- You can load partially used cartridges, as long as they contain more than 100 grams of material.
- You can replace material cartridges either before or during printing.
- If printing stops for an extended time before you replace a material cartridge, the printer may go into *Standby* or *Idle* mode. If this happens, see “Resuming Production After Printing has Stopped” on page 9.
- You can replace partially used cartridges to avoid the need for replacing them during printing.
- The cartridge type is automatically detected by the printer. If you replace a cartridge containing different Model material, a message appears recommending that you run the Material Replacement wizard to flush out the old material.

Producing Models

The Connex500/350 printer produces models by printing tray files prepared in the Objet Studio application and sent to the printer from there. For information about preparing model files for printing, see “Using Objet Studio” in this user guide or Objet Studio Help.

Preparing the Printer



Before beginning to produce models, it is recommended that you check the current printing quality of the print heads by performing a pattern test (see “Pattern Test” on page 27).

To prepare the printer for producing models:

1. Make sure that the build tray in the printer is empty and clean. If not, remove cured material with the scraper, and clean the tray thoroughly with a wet cleaning cloth.



CAUTION: Use protective gloves when cleaning the build tray, and be careful of the sharp edges of the scraper blade.

2. Make sure that there is sufficient Model and Support material loaded, as indicated in the printer interface (see figure 6-3). You may want to replace the cartridges of Model and Support material currently loaded in the printer to avoid the need for replacing them during printing.

For installing material cartridges and replacing empty ones, see “Loading Model and Support Cartridges” on page 4.

For changing the type of Model material currently loaded, see “Changing the Printing Material” on page 11.

3. On the printer interface, click the red button to switch the printer to *online* mode.

The color of the button changes from red to green (see figure 6-4). If there is a job in the Job Manager queue, it is sent to the printer.

In the printer interface, the printer mode changes from *Idle* to *Pre-print*, as the printer’s components prepare themselves for production:

- The print block is heated.
- The UV lamps are powered and they warm up.

When printing begins, Objet Studio sends seven slices to the printer. This is the standard buffer between Objet Studio and the printer. As each slice is printed, another slice is sent to the printer.

Depending on the size of the model(s) to be produced, printing can take between several hours to several days. As long as there is enough Model and Support material in the supply cartridges, printing proceeds automatically until the job is finished.



During printing, the server computer must remain on and it must communicate with the Connex printer. Do not log-off Windows until printing is finished.

The Connex500/350 printer uses one or two Model-material cartridges and one Support-material cartridge to produce models. If additional cartridges are installed and they are not needed for the current print job, the printer interface indicates which are being used:

- *Blue cartridge*—used for the print job
- *Gray cartridge*—not used for the print job

You can monitor printer status indicators by switching the printer interface display. To do this, click the display toggle button in the printer interface screen.

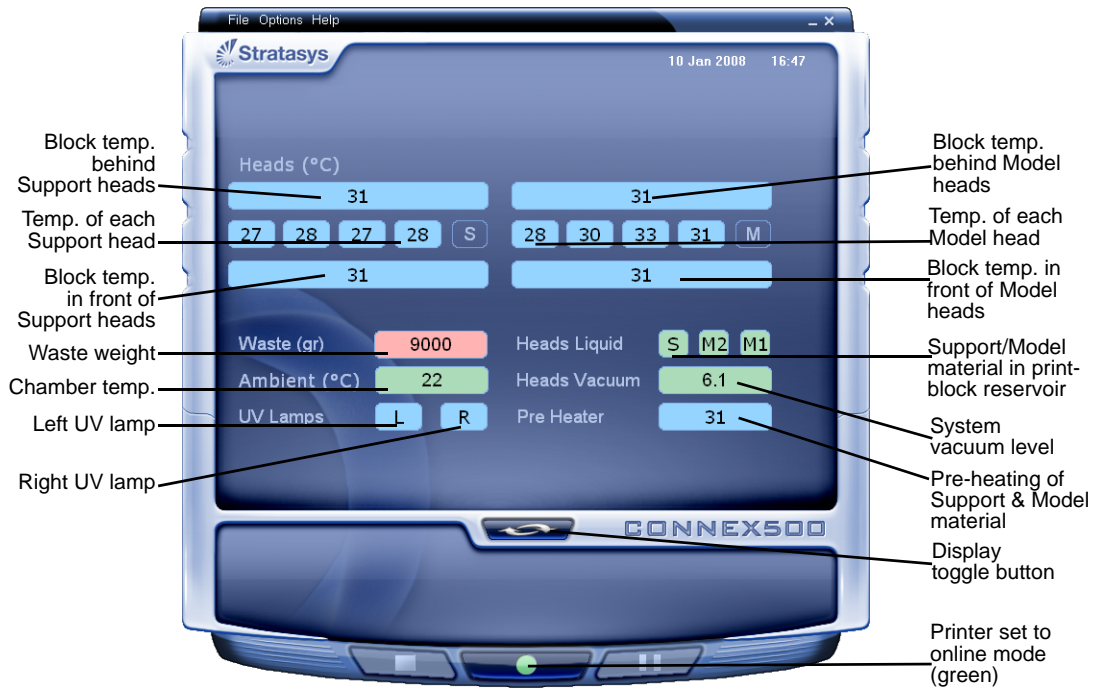

Figure 6-4: Printer indicators

Printer Interface Color Key

The background colors in the printer indicator fields tell you at a glance whether or not the value or item is suitable or ready for printing.

- *Green*—suitable/ready for printing

For example, in figure 6-4:

- Ambient*—The ambient temperature of the printing chamber is within the acceptable range.
- Heads Liquid*—The level of Model and Support material in the print-block reservoir is OK.
- Heads Vacuum*—The vacuum level in the system is within the acceptable range.

- *Red*—not suitable for printing (or indicates a warning)

For example, in figure 6-4:

- Waste*—The weight of the waste container is 9000 grams, more than allowed when beginning a print job. (See “Replacing the Waste Container” on page 68.)

- *Blue*—not ready

For example, in figure 6-4:

- UV lamps*—The UV lamps are not on.
- Heads (°C)*—The heads have not reached the temperature required for printing models (in printing mode).

The color of the material cartridges displayed in the printer interface indicates which cartridges are active for the current (or next) print job.

- *Blue*—active cartridges
- *Gray*—reserve cartridges

Printing Indicators

The printer interface screen changes when you send a print job from Objet Studio to the printer, and the printer is *on line* (see figure 6-5):

- The mode changes from *Pre-print* to *Printing*.
- The specific activity being performed is shown in the “current activity” field.
- Current job-printing information is displayed.
- The printing progress bar is displayed.
- The *Stop* and *Pause* buttons are enabled.

When the weight of a cartridge drops below 100 grams, the display of the material level in the printer interface is *red*.



Figure 6-5: Printer interface during printing

Resuming Production After Printing has Stopped

If the printing process is interrupted, Objet Studio stops sending slices to the printer. This can happen, for example, if the printing material runs out in the middle of a print job, and you don't replace the empty cartridge immediately. After the printer changes to *Standby* or *Idle* mode, you need to resume printing from the *Job Manager* screen of Objet Studio.



After printing stops, the printer goes into *Standby* mode, when heating of print heads is reduced. About 10 hours later, the printer goes into *Idle* mode, when heating of print heads is stopped.

To continue printing the model:

1. If the printer is in offline mode, switch it to online mode by clicking the red button at the bottom of the printer interface (see figure 6-3 on page 3).
The button changes from red to green (see figure 6-4 on page 6).
2. If you don't know why printing has stopped, make sure that the connection between the printer and the server computer is active.
3. In the *Job Manager* screen of Objet Studio, click the *Resume* icon .
4. In the *Continue from Slice* dialog box that appears, confirm the slice number, after checking the printer interface.



Figure 6-6: Printer interface after interrupted printing



Figure 6-7: *Continue from Slice* confirmation in Objet Studio (*Job Manager* screen)

5. If, for any reason, the correct number does not appear in the dialog box, enter the number and click OK.

You cannot continue printing the model if:

- The number of the last slice printed does not appear in the printer interface, even if the server computer displays the *Continue from Slice* confirmation dialog box.
- There was a relatively long interruption in printing, even if the “last slice” and “continue from slice” indicators are correct. The part of the model already printed may deform or shrink, and there might be a visible difference between it and the newly printed part. The effects of a printing stoppage on a model depend on the model size and structure, Model material used, ambient temperature and the length of the stoppage.

If you cannot continue printing:

1. Cancel the print job in the *Job Manager* screen.
2. Remove the partially printed model from the build tray.
3. Restart the job from the *Job Manager* screen (in *Objet Studio*).



You can stop and later resume printing from either the printer interface or from the *Job Manager* screen of *Objet Studio*. After clicking the *Stop* button on the printer interface, you can resume printing only from the *Job Manager* screen. However, after clicking the *Pause* button in the printer interface, you can only resume printing from the printer interface.

Changing the Printing Material

Before producing models using a different type of printing material than is currently installed, run the Material Replacement wizard to flush the print block and feed tubes.



You should carefully plan printing models with different Model materials to avoid unnecessary waste of the materials currently loaded. The amount of material flushed depends on the flushing cycle chosen and if you are replacing one or both Model cartridges.

To replace the printing material with the wizard:

1. Start the Material Replacement wizard from the *Options* menu.



Figure 6-8: Starting the Material Replacement wizard

2. In the opening screen, click Next.
3. If the printer cover is not closed, a screen appears, prompting you to close the cover. Confirm that it is closed and click Next.

4. In the *Compartment Selection* screen, select the compartment(s) containing the printing material you want to replace, and click Next.

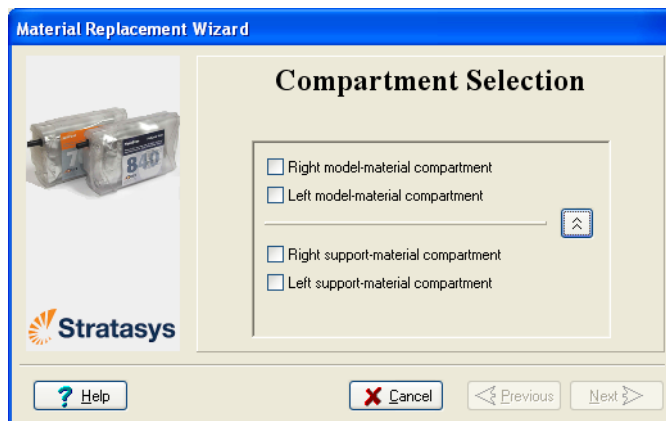

Figure 6-9: *Compartment Selection* screen

5. From the drop-down menu, choose the material you want to install, and click Next.



Figure 6-10: *Material Selection* screen

6. The Material Replacement wizard continues as follows:
 - If, according to your selections in the previous wizard screens, you are replacing *both* Model material cartridges, and the printer will be loaded with two cartridges containing the *same* Model material, the printer flushes the entire system, and prepares for printing in *Single-Material* mode (see below). *Continue with step 8 on page 6-14.*
 - If, according to your selections in the previous wizard screens, you are replacing *both* Model material cartridges, and the printer will be loaded with two *different* Model materials, the printer flushes the entire system, and prepares for printing in *Digital-Material* mode (see below). *Continue with step 8 on page 6-14.*
 - If, according to your selections in the previous wizard screens, you are replacing only *one* of the Model-material cartridges, and the

printer will be loaded with cartridges containing two *different* Model materials, the *Printer Mode Selection* screen appears.

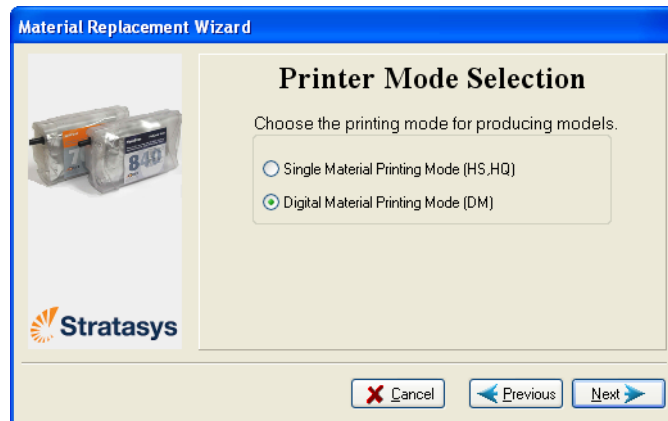

Figure 6-11: Printer-mode selection

7. Choose whether you want to produce models in *Single Material* mode or in *Digital Material* mode, and click **Next**.

➤ Single Material mode

Four print heads are used to print, using one Model material.

- This mode is required to produce build trays with the *High Quality* setting, and to produce trays with the *High Speed* setting, using only one Model material.

➤ Digital Material mode

Each of the Model materials loaded is used in two of the print heads.

- If only one of the Model materials is required for printing, models are produced using two print heads. This makes it unnecessary to replace the other Model material.
- If Model-material substitution is allowed, the printer produces trays with the *High Speed* setting using a mixture of Model materials (see “Model Material Substitution” on page 5-51).

Continue with step 8 on page 14.

8. In the *Flushing Options* screen (see figure 6-12), choose how thoroughly you want to flush the system.

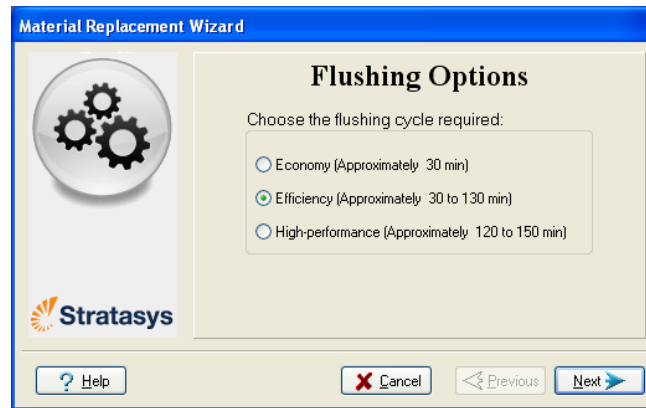

Figure 6-12: *Flushing Options* screen

- *Economy*. This cycle can be used when replacing a light-colored Model material with a darker material (such as TangoBlack™ or VeroBlack™), or if the exact color of the printed models is unimportant.

The wizard flushes the system with the minimum amount of material needed to ensure that models have the mechanical properties of the new material.

- *Efficiency*. This option is adequate, in almost all situations, for printing models with uniform and accurate color. It is recommended because it can potentially save 25 to 75 percent of the material used to flush out the old material, compared to the *High Performance* cycle. Note, however, that there may be times when the shade (color) of the printed model is slightly affected by material previously used.

The wizard identifies the feed tubes and print heads requiring cleaning, based on your selections in the previous screens, and flushes only these parts of the system.

- *High Performance*. Use this cycle when the printed models must have the *exact color* of the new material.

The wizard thoroughly flushes *all* of the feed tubes and print heads needed for printing, based on your selections in the previous screens. This is done even if a selected material is already present in the system, since it might contain small amounts of material previously used.

- Click **Next**, and take note of the warning screen.

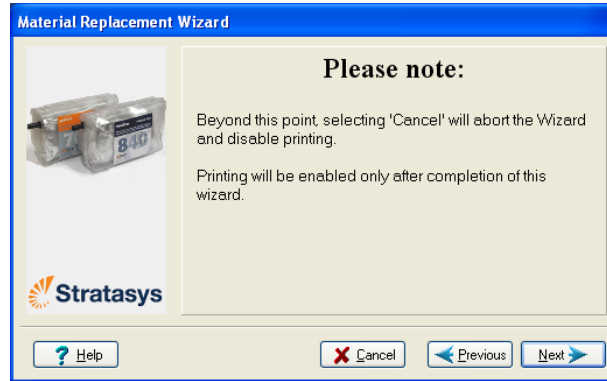

Figure 6-13: Material Replacement warning screen



Once you start this procedure, you must complete it before you can produce models with the Connex printer. To perform the procedure at another time, click **Cancel**. If you continue (by clicking **Next**) and you do not complete the procedure, you must start the Material Replacement wizard again before producing models.

- Click **Next**.
- When prompted, load the new cartridge(s). Confirm this in the wizard screen and click **Next**.

After identifying the cartridge(s), the printer begins filling the print heads with the new Model material.

The approximate time needed for this process appears in the wizard screen, and the elapsed time is displayed.

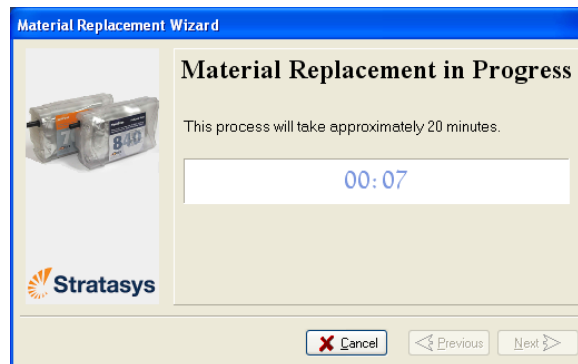

Figure 6-14: Material replacement: filling heads with new material

- Click **Done** to close the wizard.
The printer-control application is automatically updated, and the interface displays the new material(s). The Objet Studio application (on the printer-server computer) is also updated and displays the new material(s).
- Inspect the area around the purge unit and clean it, if necessary.



CAUTION: Dispose of all material cartridges in accordance with all applicable laws and regulations. If necessary, the cartridges can be disassembled for recycling. If this is done, protect the person handling the cartridges from direct exposure to uncured resins.

Keeping the Printer in Idle Mode

Between printing jobs, the Connex500/350 printer can be kept on for up to one week. If the printer will not be used for more than a week, use the Shutdown wizard to automatically perform the procedures that must be done before turning off the printer (see “Shutting Down the Printer,” below).

When the printer stops producing models, the printer software automatically reduces the temperature of the print heads as follows:

Time after printing	Mode	Change in heating of print heads
first 15 minutes	<i>Standby 1</i>	none
next 10 hours	<i>Standby 2</i>	heating reduced (to room temp.)
after 10 hours	<i>Idle</i>	heating stopped

Note: The printer mode is indicated in the green field on the left of the interface (see figures 6-3, 6-4 and 6-5 on pages 3, 6 and 8).

If, after printing a job, you know that the printer will not be used for 10 hours or more, you can immediately turn off the heating of the print heads by putting the printer into *Idle* mode.

To put the printer into *Idle* mode:

- From the *File* menu (in the printer interface) click Exit.

Note: The printer remains in *Idle* mode until you open the Connex printer application and begin printing again.



When the printer is in *Idle* mode, do **not** turn it off. It can remain in this mode—with the cover closed—for up to a week. For longer periods, shut down the printer by running the Shutdown wizard (see below).

Shutting Down the Printer

You only need to shut down the Connex printer if it will not be used for a week or more. Otherwise, the printer can remain on, in *Idle* mode.



The Shutdown process flushes printing materials from printer components. To avoid flushing out valuable material, make sure to print models at least once a week. Many printer operators use this opportunity to print customer samples or test models.

To properly shut down, the printer needs to perform several processes. These are controlled by the Shutdown wizard. **Do not attempt to shut down the printer by simply closing the computer interface (the printer-control application), and never disconnect power to the printer before completing this wizard.**



CAUTION: Not using the printer for an extended period without first running the wizard can cause serious damage to print heads and other expensive printer parts.

Depending on the length of time the printer will not be used, you can choose between a short shutdown procedure, and a more thorough procedure.

- **Up to 10 days:** The wizard empties the print block of Model and Support material, to prevent leaks. This takes about 10 minutes.
- **More than 10 days:** The wizard empties the print block, then flushes the system with cleaning fluid. This takes up to 35 minutes, and you must be present to load cleaning-fluid cartridges when instructed.

To run the Shutdown wizard:

1. Start the Shutdown wizard from the *Options* menu.



Figure 6-15: Shutdown wizard, opening screen

2. Click Next.

- Choose the appropriate option for the length of time that the printer will not be used—less or more than ten days.

Note: Before selecting *More than 10 days*, make sure that cleaning-fluid cartridges are available.



Figure 6-16: Shutdown options

- In the next screen, verify that the tray is empty and click Next. The shutdown procedure begins.

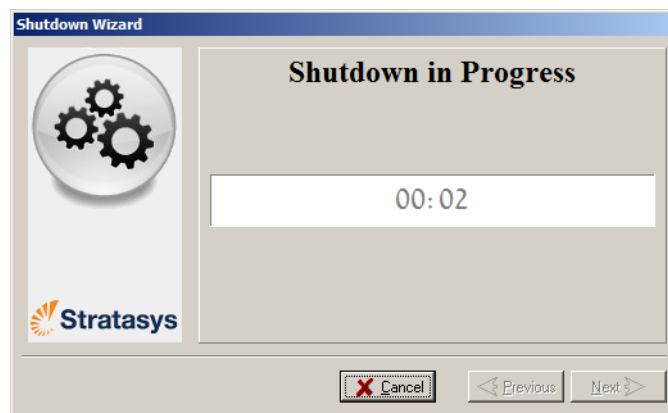

Figure 6-17: Shutdown progress screen

- When the final wizard screen appears, close the printer-control application and shut down the built-in computer.

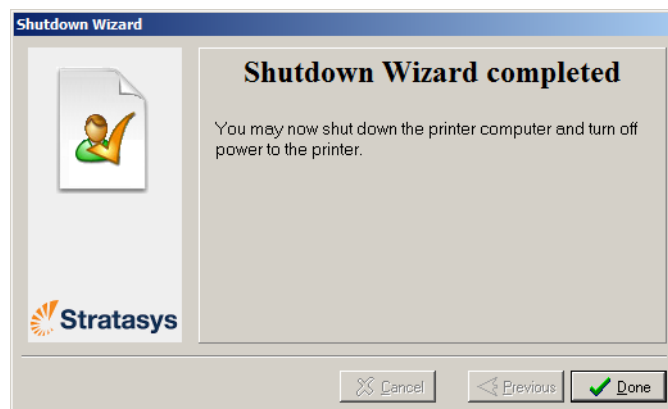

Figure 6-18: Final Shutdown wizard screen

- After the printer computer shuts down, turn off the main power switch at the back of the printer (see figure 6-2 on page 2).

Maintaining the Printer

The performance of routine maintenance tasks is essential for getting satisfactory results from Connex 3D printers. Perform the tasks at specified intervals for optimum performance.

Routine Maintenance Schedule

Frequency	Task	For More Information
Before / after printing	Check UV lamp overheating indicator.	See "UV Lamp Check" on page 22.
Before / after printing	Clean the print heads and the roller surface.	See "Cleaning the Print Heads and the Roller" on page 22.
Daily	Clean and inspect the wiper.	See "Cleaning and Replacing the Wiper" on page 25.
Weekly	Perform the Pattern test.	See "Pattern Test" on page 27.
Weekly— <i>when printing with MED610</i>	Calibrate the UV intensity.	See "Testing and Calibrating the UV Lamps" on page 50.
Weekly	Restart the printer computer and the server computer.	
Weekly	Clean the roller waste collector.	See "Cleaning the Roller Waste Collector and Inspecting the Roller Scraper" on page 29.
Every 300 hours of printing (A reminder message appears.)	Calibrate the UV intensity.	See "Testing and Calibrating the UV Lamps" on page 50.
Monthly, and after replacing print heads	Check the alignment of the print heads.	See "Aligning the Print Heads" on page 34.
Monthly	Inspect the exhaust system (duct, fan, connections).	
Monthly	Calibrate the load cells.	See "Calibrating the Load Cells" on page 56.
Every 3500 hours of printing	Preventive maintenance visit by authorized service engineer.	Contact your Stratasys service provider.

Maintenance Counters

The printer computer application records the dates and frequency for each maintenance task. You can display the Maintenance Counters screen from the *Options* menu.

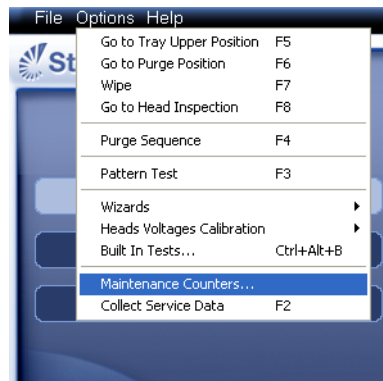

Figure 6-19: Selecting Maintenance Counters

If there is a maintenance task due, this is indicated on the main interface screen.

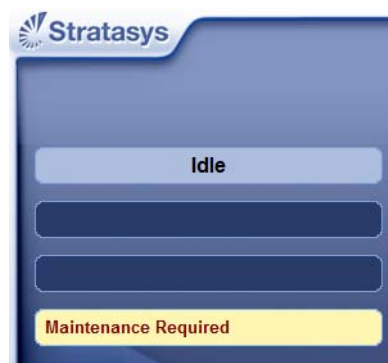

Figure 6-20: *Maintenance Required* indicator

If this indicator appears, you can display the Maintenance Counters screen by clicking on it.



The *Maintenance Required* indicator appears by default for most operator-performed maintenance tasks. The check box under “User Warning” controls whether or not it appears when a particular task is due.

Item	Total	Dated	Warning Time	User Warning
Total Printing time	971	27/08/09	N/A	
PM is Due	1003	27/08/09	3500	<input checked="" type="checkbox"/>
Operator Maintenance				
UV Calibration	1	27/01/15	300	<input checked="" type="checkbox"/>
Heads Cleaning	1	27/01/15	170	<input checked="" type="checkbox"/>
HCU	18	06/01/15	300	<input checked="" type="checkbox"/>
Pattern Test	18	25/01/15	170	<input checked="" type="checkbox"/>
Roller Bath Inspection	0	06/01/15	170	<input checked="" type="checkbox"/> <input type="button" value="Reset"/>
Wiper Cleaning	18	06/01/15	170	<input checked="" type="checkbox"/>
Head Alignment	18	06/01/15	300	<input checked="" type="checkbox"/>
Load Cell Calibration	18	06/01/15	500	<input checked="" type="checkbox"/>
Restart Computer	8	27/01/15	170	<input checked="" type="checkbox"/> <input type="button" value="Reset"/>
Blade Replacement				
Wiper Blade	18	22/01/15	1000	<input checked="" type="checkbox"/> <input type="button" value="Reset"/>
Roller Blade	1	27/01/15	1000	<input type="checkbox"/> <input type="button" value="Reset"/>

Close Save

Figure 6-21: Maintenance Counters screen

For maintenance tasks that are controlled by wizards, the dates and printing times are reset automatically when the relevant wizard is run and completed successfully. Manual maintenance tasks (for example, roller inspection and wiper replacement) are reset by clicking the reset button in the screen.

UV Lamp Check

A heat-sensitive label is fixed to the UV lamp covers as a warning against overheating. Its center changes from white to black if the temperature of the cover reaches 65 °C (150 °F). If this occurs, do not use the printer, and call your service provider. As a precaution, it is recommended that you check the label before and after printing.

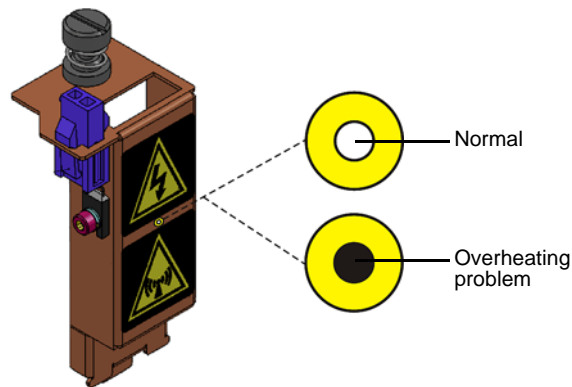

Figure 6-22: Heat-sensitive label on UV lamp cover



If the UV lamp continues to overheat, and the temperature around the lamp reaches 90 °C (194 °F), a heat fuse cuts the power to the UV lamp and the motion motors. In the unlikely event that this occurs, the printer cannot be used until it is serviced by an authorized service engineer.

Cleaning the Print Heads and the Roller

Periodic inspection and cleaning of the orifice plates on the bottom of the print block ensures that the print nozzles are not clogged. A wizard guides you through the procedure, and adjusts components of the printer to enable you to perform it. This procedure takes about 20 minutes, and should be done at the beginning of the work day or before a big printing job.

To clean the print heads and the roller:

1. Prepare—
 - isopropanol (IPA— isopropyl alcohol) or ethanol (ethyl alcohol)
 - disposable cleaning gloves
 - a supplied cleaning cloth or equivalent
 - a mirror
2. Start the Head Cleaning wizard from the *Options* menu (see figure 6-27 on page 25).

3. Follow the instructions on the wizard screens, and select the confirmation check boxes.



Figure 6-23: Head cleaning procedure—wizard screen

4. Click Next.
The printer prepares for you to clean the print heads.
5. When the following screen appears, open the cover.

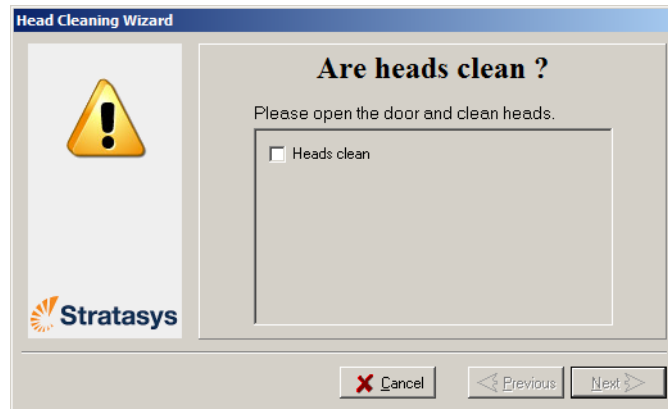

Figure 6-24: Head cleaning wizard—steps 5–11



WARNING: The print head orifice plates (bottom surface) might be hot, so proceed with caution.

6. Place the mirror on the build tray.
7. Put on the gloves.



CAUTION: Uncured printing material on the print heads might cause skin irritation. Use disposable cleaning gloves to protect your hands.

8. Soak the cleaning cloth with alcohol.

9. Clean the orifice plates, with a back-and-forth motion (see figure 6-25). Use the mirror to make sure that you have removed all of the residue material.

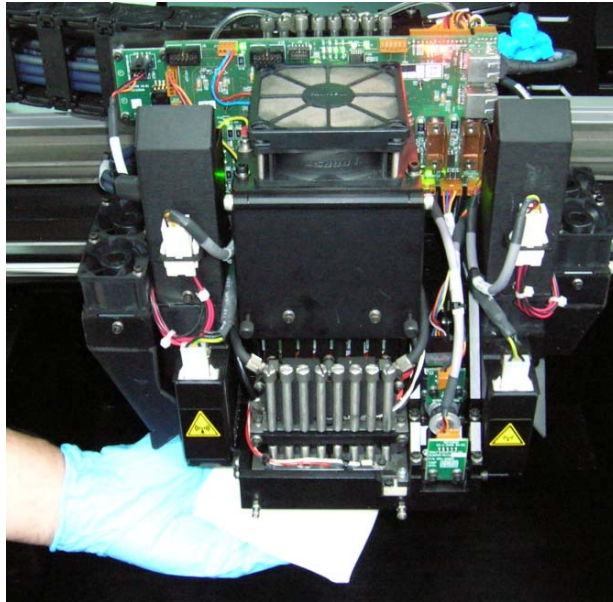

Figure 6-25: Cleaning the heads

10. Clean the entire roller surface, by rotating it as you clean.



Use this opportunity to clean the glass lens on the UV lamps.

11. When you have finished cleaning, select the confirmation check box in the wizard screen (see figure 6-24) and click Next.
12. Remove the cleaning materials from the printer and close the cover.
13. Select the confirmation check boxes in the wizard screen and click Next.

The head-purge cycle begins. When this is complete, the final wizard screen appears.

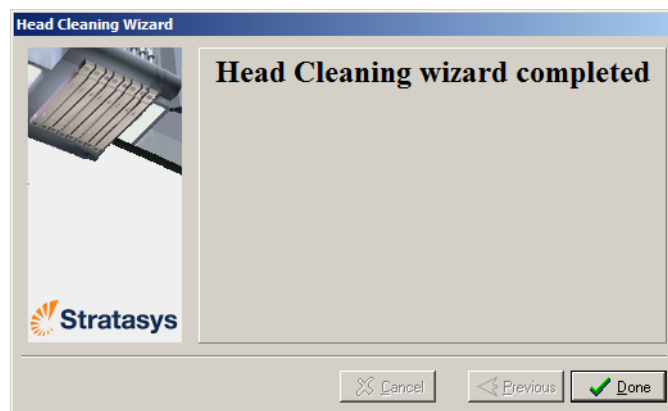

Figure 6-26: Head-cleaning wizard—final screen

14. Click Done to close the wizard.

Cleaning and Replacing the Wiper

A rubber wiper removes excess material from the print heads after the purge sequence. This is done automatically before each print job, and performed manually during maintenance tasks. You should clean the wiper and surrounding area at least once a week. If the wiper is damaged or worn, replace it.

To inspect and clean the wiper:

1. Prepare—
 - isopropanol (IPA— isopropyl alcohol) or ethanol (ethyl alcohol)
 - disposable cleaning gloves
 - the supplied cleaning cloth or equivalent
 - a spare wiper
2. Start the Wiper Cleaning wizard from the *Options* menu.



Figure 6-27: Starting the Wiper Cleaning wizard

3. In the opening wizard screen, click Next.
4. Make sure that the build tray is empty, and close the printer cover.

Confirm this in the wizard screen and click Next.

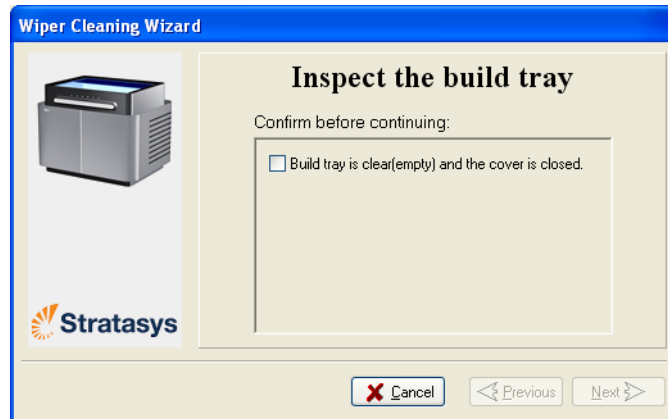

Figure 6-28: Wiper Cleaning procedure—step 4

5. When the following screen appears, open the cover.

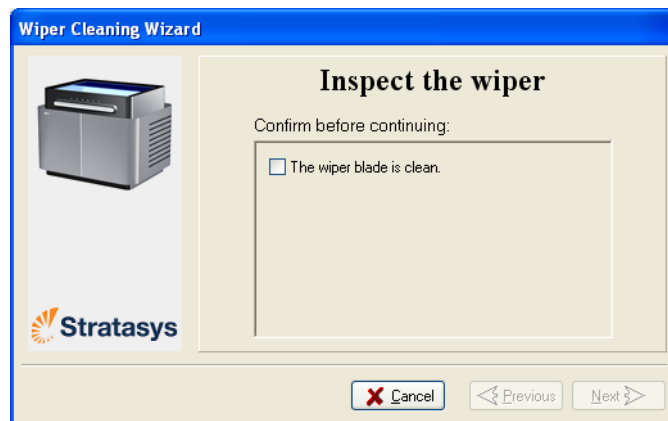

Figure 6-29: Wiper Cleaning wizard during steps 6–9

6. Put on the cleaning gloves.
7. Using a generous amount of alcohol on the cleaning cloth, remove any material remaining on the wiper and the surrounding area.
8. Inspect the wiper.
 - If the wiper is scratched, torn or worn, or if you cannot clean it completely, replace it.
 - a. Grasp it and pull it up and out of its bracket.
 - b. Insert the new wiper blade, *making sure that it is straight and secured well on both sides.*
9. In the wizard screen (see figure 6-29), confirm that the wiper blade is clean, and click Next.
10. Remove all tools and cleaning materials from the printer, and close the cover.

11. Confirm this in the wizard screen, and click Next.

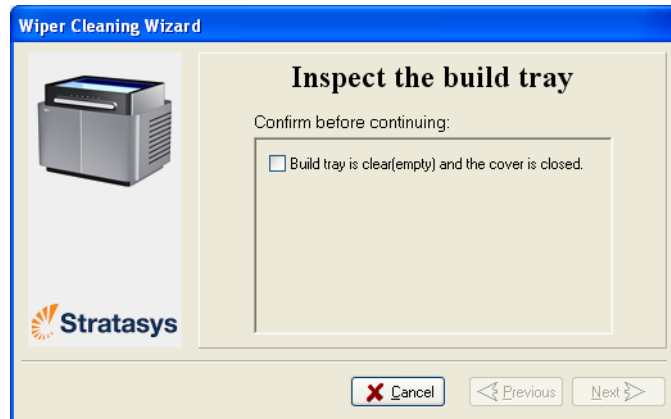

Figure 6-30: Confirmation screen

12. Click Done to close the wizard.

Pattern Test

The pattern test is the basic verification of the printer's ability to produce quality models, since it demonstrates the condition of the nozzles in the print heads. Make sure, therefore, that you perform this test weekly, and whenever you suspect a printing problem.

To perform the pattern test:

1. Make sure that the build tray is empty.
2. Prepare a sheet of pink paper—A-4 or Letter size.
3. In the printer, tape the pink paper to the surface left of the build tray.
4. Press F3, or open the *Options* menu and select Pattern Test.

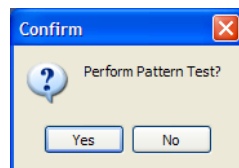

Figure 6-31: Pattern Test confirmation

5. If the build tray is *not* clear, click No in the following dialog box. This lowers the build tray, so that models on the tray are not damaged.

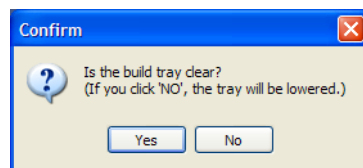

Figure 6-32: Build tray (Z) level adjustment

The printer prints a series of lines on the test paper (see next figure).

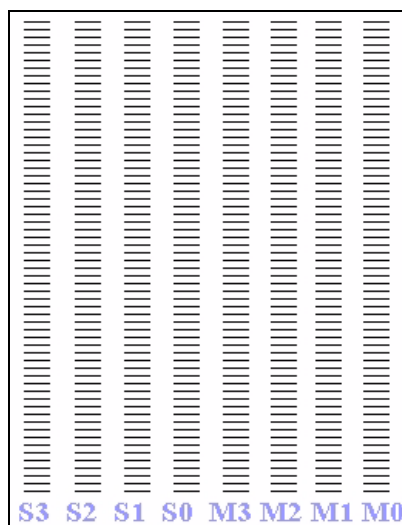

Figure 6-33: Sample Pattern Test

6. Carefully inspect the test paper to see if there are missing lines. Too many missing lines, especially if they are in the same area, indicates that the quality of printing when producing models will be poor. If this is the case, see “Improving Print Quality,” below.

Note: Acceptable model quality is subjective, and depends on the type and scale (size) of the models produced. As a rule, however, more than 10 missing lines in one area of a column is considered unacceptable.

Improving Print Quality

If you suspect that print quality is poor, perform the pattern test (see “Pattern Test” on page 27). If the results are poor, use the following procedure to improve print quality.

If the results of the last pattern test are poor:

1. From the *Options* menu, select **Purge Sequence**, or press F4.
2. In the confirmation dialog box, click **Yes**.
The print heads are purged of Model and Support material, and the wiper removes excess material from them.
3. Repeat the purge sequence.
4. Perform the pattern test.

If the results of the pattern test are still poor:

1. Manually clean the print heads (see “Cleaning the Print Heads and the Roller” on page 22).
2. Perform the purge sequence.
3. Perform the pattern test.

If the results of the pattern test are still poor:

1. Carefully clean the print heads again, making sure there is no residue left on them.
2. Perform the purge sequence.
3. Perform the pattern test.

If the results of the pattern test are still poor:

- Optimize the print heads and replace faulty print heads, if necessary (see “Calibrating (Optimizing) Print Heads” on page 38).

Cleaning the Roller Waste Collector and Inspecting the Roller Scraper

The roller waste collector removes waste material scraped from the roller. Suction removes this waste to the printer's waste container.

This assembly should be cleaned weekly to prevent a blockage in the tubes leading to the waste container, so that waste material does not overflow into the printer.

To clean the roller waste collector:

1. Prepare—
 - M2.5 and M2 Allen® keys
 - disposable cleaning gloves
 - isopropanol (IPA— isopropyl alcohol) or ethanol (ethyl alcohol)
 - cleaning cloth
 - cotton swabs (Q-tips or similar)
2. Put on the gloves.
3. Remove the right UV-lamp assembly:
 - a. Disconnect the UV power cable and the fan power cable.

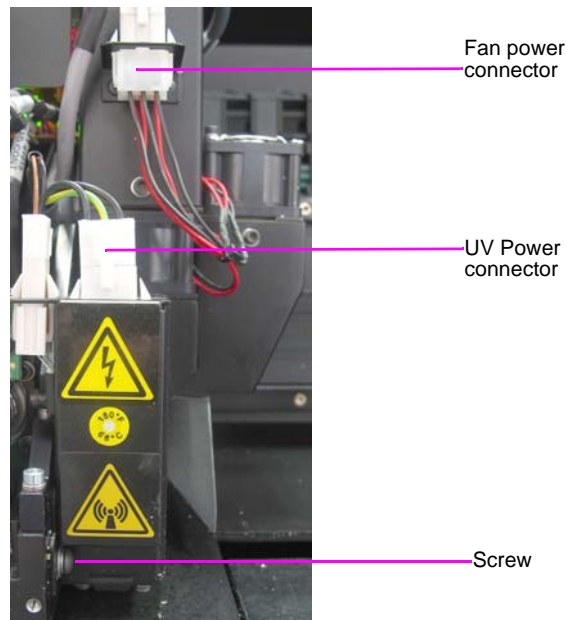

Figure 6-34: Disconnecting the right UV assembly

- b. Remove the screw attaching the right UV lamp to the print block, and then pull and lift up the UV lamp.

4. Loosen the two screws securing the suction tube on the print block.

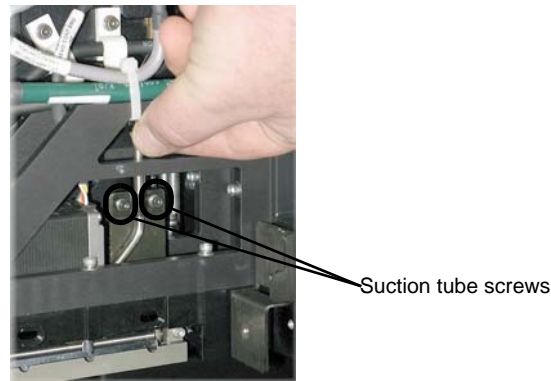

Figure 6-35: Lifting the suction tube

5. Lift the suction tube to secure it in a raised position.
6. Remove the two screws securing the covering of the roller waste collector and remove it.



Be very careful to save the covering screws. These are special screws; if they are lost, you need to order replacements.

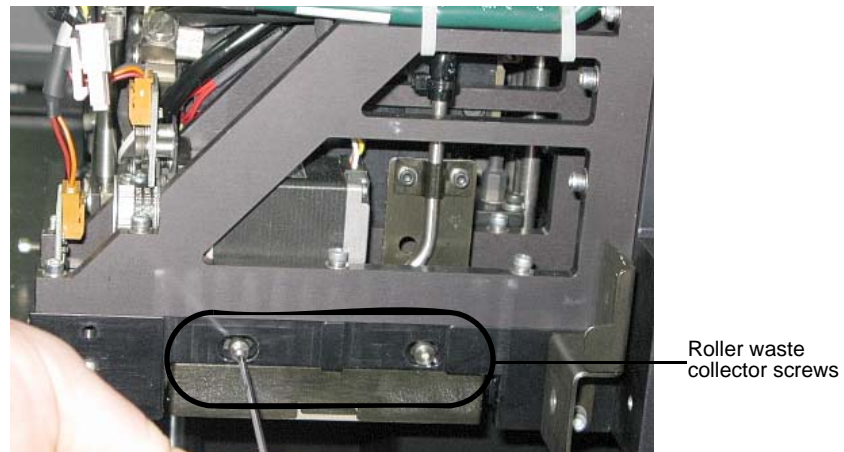

Figure 6-36: Removing the roller waste collector covering

7. Remove the covering by pulling it out, and then lower it.
8. Clean the roller waste collector and the scraper blade surface using cotton swabs. Make sure to remove any remaining printing materials.



Figure 6-37: Cleaning the roller waste collector



Before replacing the covering, you can check the effectiveness of the roller scraper — see below.

To check the effectiveness of the roller scraper:

1. Put on the cleaning gloves.
2. Wet a cloth with isopropanol.
3. Use the cloth to wet the bottom of the roller.
4. Turn the roller slowly with your hand. As the blade scrapes the roller, make sure the isopropanol is spread evenly over the entire length of the blade.
5. Inspect the roller. If it is not dry, replace the blade. (See “Replacing the Roller Scraper” on page 32.)
6. Before returning the roller waste collector to the print block, make sure that the pins are clean.



Figure 6-38: Roller waste collector pins

To re-assemble the components:

1. Return the roller waste collector to the print block and screw on the covering (see figure 6-36 on page 30).
2. Loosen the screws securing the suction tube.

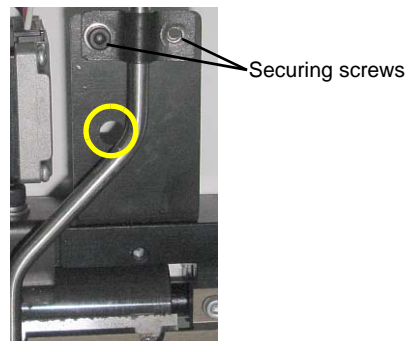

Figure 6-39: Suction tube correctly positioned

3. Lower it so that the hole in the panel behind the suction tube is visible, and tighten the screws to secure the tube.
4. Attach the right-UV-lamp assembly to the print block and reconnect the UV power and fan cables.

Replacing the Roller Scraper

You should replace the roller scraper blade—

- after 1,000 hours of printing.
- if it does not effectively keep the roller clean.



You should periodically test the effectiveness of the roller scraper when you clean the roller waste collector. See “Cleaning the Roller Waste Collector and Inspecting the Roller Scraper” on page 29.

To replace the roller scraper:

1. Prepare—
 - a new roller scraper blade (KIT-01026-S)
 - a Phillips 1x75 mm screwdriver
 - M2.5 and M2 Allen® keys
2. Remove the right UV lamp and the roller waste collector covering (see steps 3 to 6 on page 29.)
3. Loosen the two screws securing the roller waste collector and pull it out.

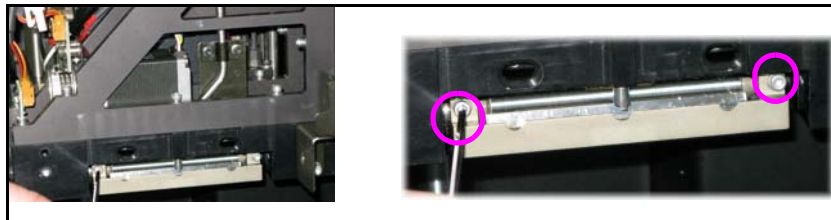

Figure 6-40: Removing the roller waste collector

4. Remove the screws that secure the roller scraper assembly.

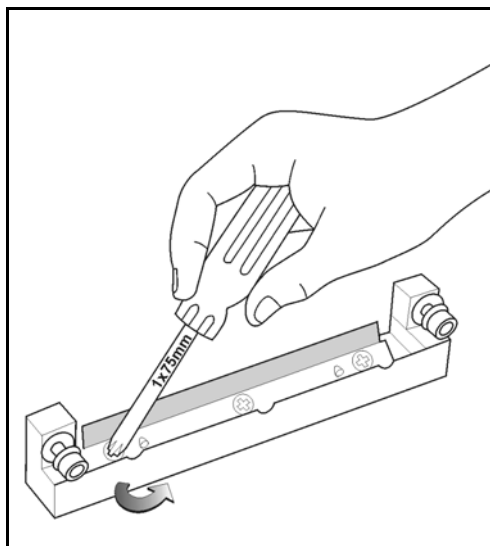

Figure 6-41: Removing the roller scraper screws

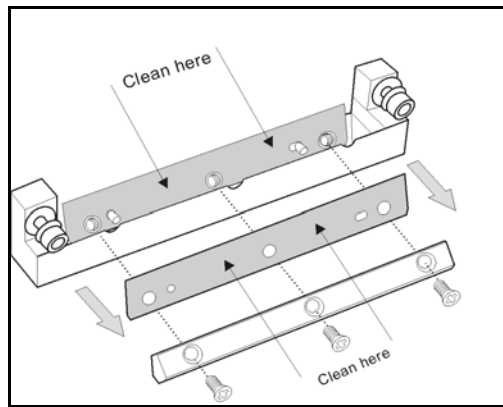

Figure 6-42: Removing the old roller scraper blade

5. Remove the scraper blade and discard it.
6. Place the new scraper blade onto the pins in the holder, as shown.

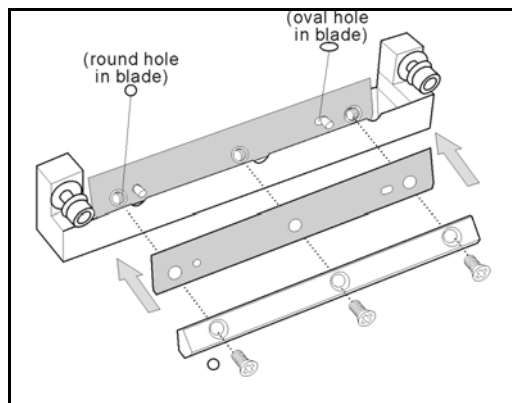

Figure 6-43: Inserting the new roller scraper blade

7. Insert and tighten the roller scraper blade screws.

Important:

- Tighten the screws in the order shown in figure 6-44.
- Use the new screws supplied in the replacement kit.

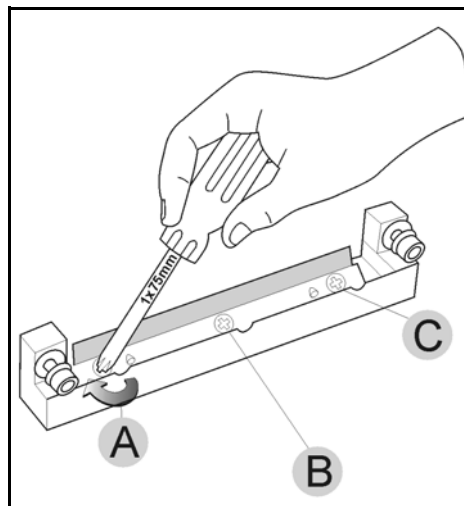

Figure 6-44: Tightening the roller scraper screws

8. After tightening the screws, inspect the blade and make sure that it is straight. If necessary, loosen the screws and tighten them again, evenly.
9. Return the roller waste collector assembly and the right UV lamp to the print block. See steps 6 to 4, from page 31.

Aligning the Print Heads

You should check the alignment of the print heads—

- once a month
- after replacing one or more heads
- if model quality is not acceptable even after cleaning the orifice plate on the bottom of the print block (see “Cleaning the Print Heads and the Roller” on page 22)

This procedure takes about 20 minutes.

To check the alignment of the print heads:

1. Prepare—
 - a transparency sheet— A-4 or Letter size
 - any type of sticky tape, to fasten the transparency sheet to the build tray
2. Start the Head Alignment wizard from the *Options* menu (see figure 6-27 on page 25).
3. Click Next to begin, and close the cover.
4. In the wizard screen, select the check box to confirm that the cover is closed, and click Next.
5. When instructed to do so, place the transparency on the build tray— next to the left and rear edges of the tray, as shown in the following figure.



Figure 6-45: Positioning the transparency on the build tray

6. Make sure that the transparency sheet is lying flat, and tape it to the tray.
7. In the wizard screen, select the check box to confirm that the transparency sheet is on the build tray, and click Next.

The printer prints the head alignment test on the transparency.

- When the following screen appears, remove the transparency.

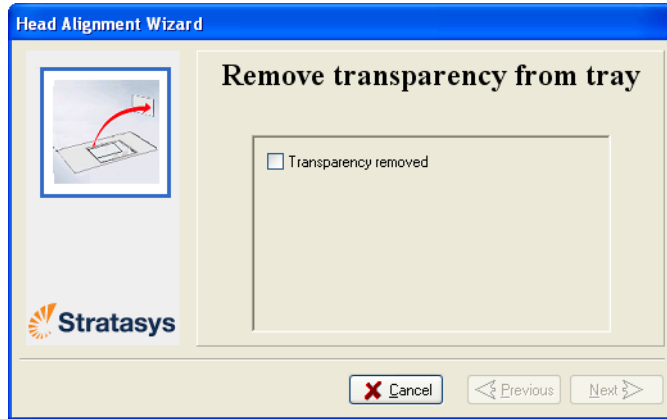

Figure 6-46: Head Alignment wizard—steps 8–10

The transparency sheet is printed with sets of vertical lines in seven columns, each showing the results from a different print head.

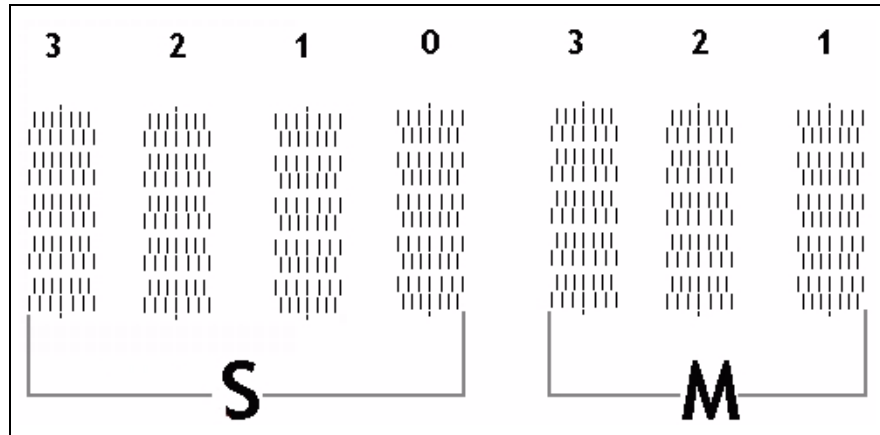

Figure 6-47: Sample head-alignment test

Note: There is no column for head H7 because its alignment is used as a reference for aligning all other heads.

- For each column of lines, use a magnifying glass or loupe to inspect pairs of consecutive rows printed on the transparency to see where the vertical lines align.

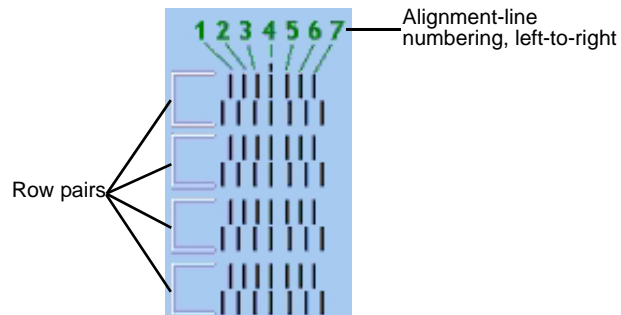

Figure 6-48: Comparing rows of alignment lines

Note: It does not matter which pair of lines you inspect, since they were all printed by the same head. Choose a pair of clearly printed lines for the inspection. (Since some nozzles may not print clearly, you may have to inspect several pairs of lines to properly view the alignment.)

Optimum head alignment is shown when the *fourth* lines in the upper and lower rows are aligned, as in figure 6-48. In the example shown, no change to the head alignment is necessary. If other lines in the set are aligned, you need to change the alignment of that head—in the next wizard screens.

10. In the wizard screen shown in figure 6-46, select the *Transparency removed* check box, and click Next.

The first in a series of alignment screens appears.

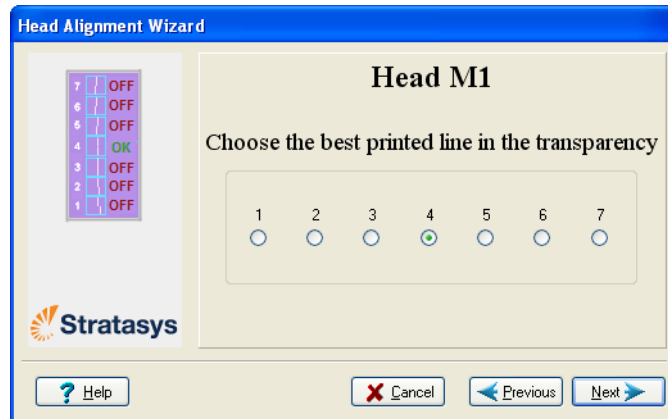

Figure 6-49: Head alignment screen

11. In the head-alignment screen, select the number that indicates which lines align in the upper and lower rows of a pair on the transparency (counting from the left) for this print head.

Note: Because the alignment of the fourth lines is optimum, the number “4” is selected, by default, in the wizard screen. This does not change the head alignment. If you select other numbers, the wizard adjusts the head alignment, accordingly.

12. Click Next to display the next head alignment screen, and again select the number representing the most closely aligned vertical lines on the transparency for that print head.

When you have finished aligning all of the heads, the following screen is displayed.

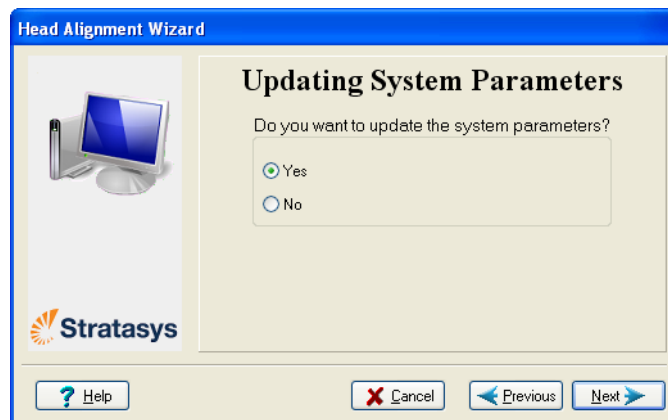

Figure 6-50: Parameter update confirmation

13. Continue as follows:
 - To make the alignment changes in the printer, make sure that *Yes* is selected, and click *Next*.
 - To recheck the alignment test results before making the alignment changes in the printer, click *Previous*.
 - If you do not want to make alignment changes in the printer at this time, select *No* and click *Next*.
14. In the following screen, you can choose to either repeat the head alignment procedure or close the wizard.
 - If the most closely aligned vertical lines for a print head were at either extreme—the first or seventh lines—choose *Yes* to run the Head Alignment wizard again, then click *Next*.

The transparency test will show if the heads are now properly aligned, and—if not—the wizard will allow you to “fine tune” the alignment.
 - If the vertical lines for the print heads were not aligned at either extreme, choose *No* to close the wizard, then click *Next*.



Figure 6-51: Repeat head alignment option

Calibrating (Optimizing) Print Heads

The condition of the print heads directly affects the quality of printed models. To maintain optimum printing, you should test the print heads, and calibrate them to the best working configuration possible every 300 hours of printing. You should also perform this procedure...

- whenever you suspect that the condition of print heads is negatively affecting the quality of printed models
- if there is a problem with one or more of the print heads
- after replacing a print head

The print head calibration procedure consists of the following phases:

- A. Cleaning the print heads.
- B. Printing calibration samples—eight patches, each representing a print head.
- C. Examining and weighing the patches, and entering this data in a separate utility (the Head Calibration Utility) that calculates how to calibrate the print-head settings.
- D. Saving the new print-head settings.
- E. Repeating the process, as required, until the print heads calibration is optimal.

Note: This procedure can take between 30–120 minutes, depending on the condition of the print heads and the number of iterations required. If a print head cannot be calibrated for acceptable printing, the head calibration utility instructs you to replace it.

To clean the print heads:

- Refer to “Cleaning the Print Heads and the Roller” on page 22.



To accurately test and calibrate the print heads, they must be clean.

To print calibration samples:

- From the *Options* menu, select *Weight Test* and one of the following:
 - HQ Weight Test (to calibrate heads for High Quality printing)
 - HS Weight Test (to calibrate heads for High Speed printing)
 - DM Weight Test (to calibrate heads for Digital Material printing)

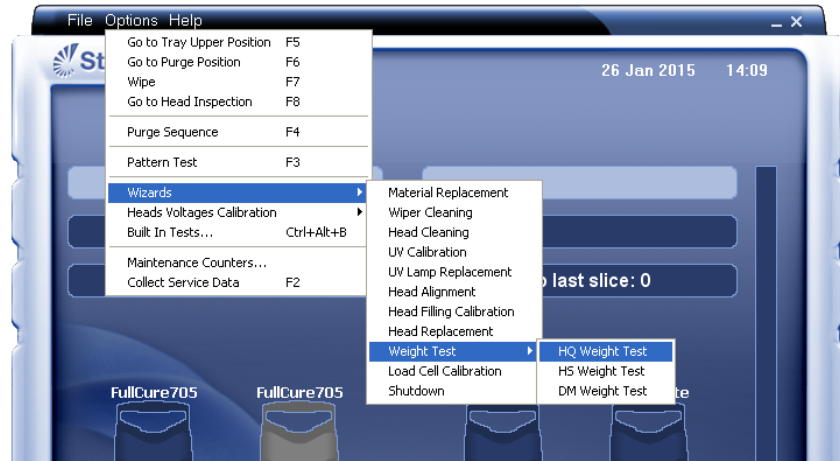

Figure 6-52: Printing print-head calibration samples

- Set the printer to on-line mode.



Figure 6-53: Printer in on-line mode

The printer prints eight calibration patches on the build tray.



To examine the calibration samples:

- Use the Missing Nozzles Ruler to determine the number of clogged (“missing”) nozzles the printed patches.

Clogged nozzles are seen in the samples as missing rows of printed material. When you match the gap in the printed sample with a line on the Missing Nozzles ruler, the number on the ruler next to the line indicates the number of missing rows.

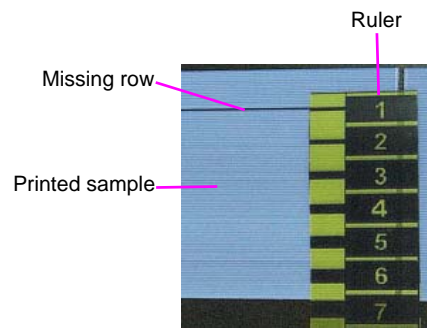

Figure 6-54: Measuring a missing row in a printed sample

In the example above, the number of missing nozzles is one (1). More than 12, or more than four consecutive clogged nozzles are an indication that you may need to replace the print head.

Note: During this procedure, the roller does not smooth the surface of the printed samples. Do not mistake the visible lines in the sample for missing material.

To complete the calibration procedure, you need to weigh the printed patches. An external head calibration utility uses these weights to adjust the voltage applied to each print head.

Replacing Print Heads

The condition of the print heads directly affects the quality of printed models. You may need to replace a print head if one or more of the following symptoms occurs:

- There are noticeable grooves in the surface of printed models.
- Visual inspection of the head reveals that its surface is damaged—peeling or bubbles in the nozzle area.
- The pattern test or the weight test reveals that more than four consecutive nozzles—or a total of more than 12 nozzles—are not functioning.
- The print-head calibration utility indicates that a head cannot be calibrated for acceptable printing—see “Calibrating (Optimizing) Print Heads” on page 38.
- The printer interface displays a warning or malfunction message relating to a print head—
 - Head Heater temperature timeout
 - Head Heater thermistor open
 - Head Heater thermistor short



Replace print heads only after attempting all other means for improving print quality (see “Improving Print Quality” on page 6-28) and after consulting with an authorized customer-support engineer.

A wizard guides you through the procedure of replacing a print head, and adjusts printer components to enable you to perform it. Only replace a print head with the aid of the wizard. The entire procedure takes 75–90 minutes, and consists of the following phases:

A. Identifying the head(s) needing replacement.

This is usually done during the head-calibration procedure. Otherwise, evidence of physical damage to the head surface or a malfunction message indicates which head needs replacing.

B. Preparing the print block for head replacement.

This is done automatically when you run the Head Replacement wizard.

C. Removing the defective print head.

D. Installing a new print head.

E. Performing head calibration.

F. Performing head alignment.

To replace a print head:

1. Prepare—

- replacement print head(s)
- isopropanol (IPA— isopropyl alcohol) or ethanol (ethyl alcohol)
- disposable cleaning gloves (supplied with the print head; or use any clean, powder-free protective gloves)
- a supplied cleaning cloth or equivalent
- a 5 mm flat-head screwdriver or a 3 mm Allen® key (depending on the type of print block)

Note: Make sure that you have these items before performing the head-replacement procedure.

2. Open the Head Replacement wizard from the *Options* menu.



Figure 6-55: Starting the Head Replacement wizard

3. In the opening wizard screen, click Next to begin.
The *Wizard Conditions* screen appears.
4. Read the conditions, select I Agree and click Next.

- Preparing the Print Block
5. Select the print head(s) needing replacement, and click Next.



Figure 6-56: Head selection screen

The printer heats and empties the print block, and prepares the printer. (This should take up to 30 minutes.)

6. The following screen appears when the printer is ready for you to replace print heads.

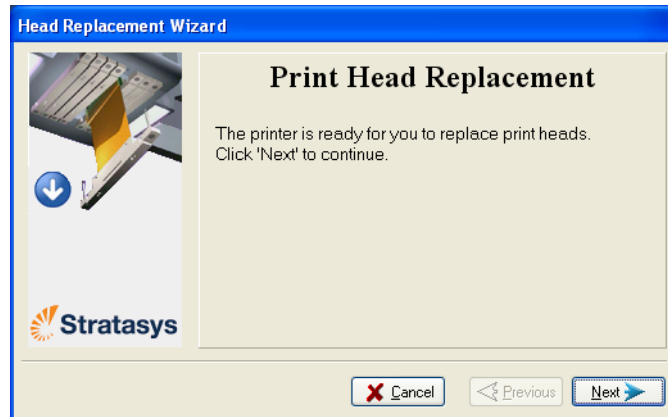

7. Put on the protective gloves and open the printer cover.

Note: The printer disconnects power to the heads for your safety.

- Removing the Defective Head
8. On the print block, release the upper and lower screws that secure the print head in the block. (If necessary, you may use a screwdriver or hex (Allen®) key to loosen the screws.)

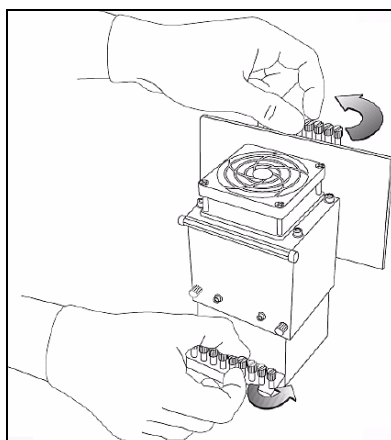

Figure 6-57: Releasing the locking screws

9. Press down on the upper and lower locking screws to release the print head.

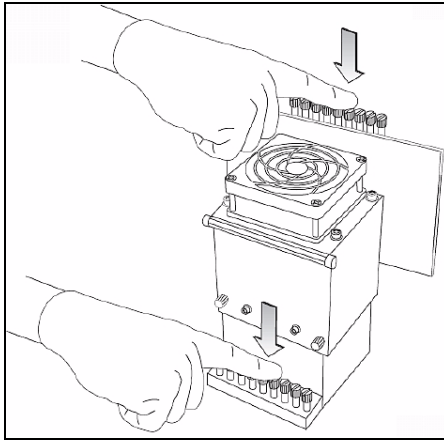

Figure 6-58: Releasing the print head

10. Loosen the screws on the door of the compartment protecting the print-head driver cards (A), then pull and lift up the door (B).

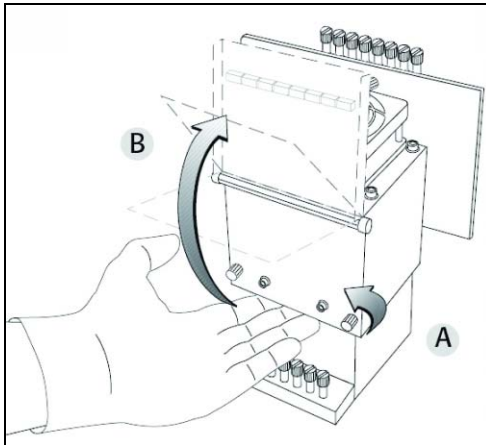

Figure 6-59: Opening the print-head compartment

11. Pull the print-head driver card out of its socket so that the head is free (A), and remove it from the bottom of the print block (B).

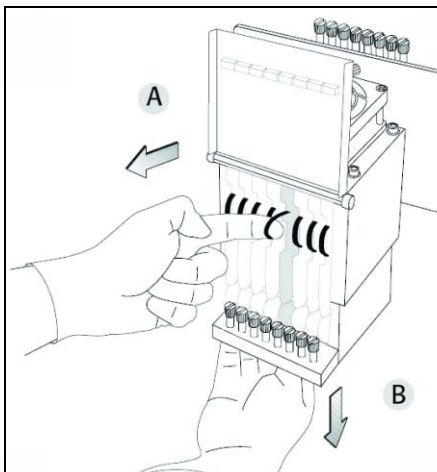

Figure 6-60: Releasing the print-head driver card to remove the head

12. Make sure that along with the head, you remove the two rubber O-ring seals.

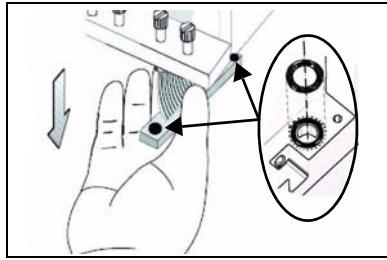

Figure 6-61: O-ring seals on the print head



Important: If the seals are not removed with the head, they are probably stuck to the print block housing. If so, remove them.

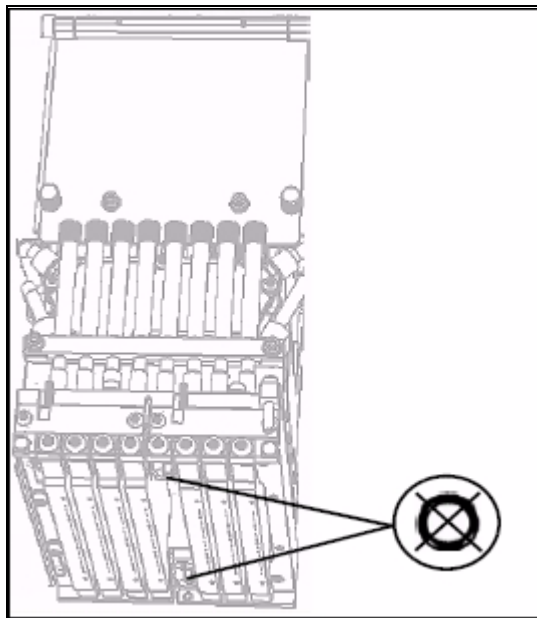

Figure 6-62: Making sure the O-rings are not stuck to the print block

- Installing the New Head
13. Inspect the replacement head, and make sure that the O-ring seals are in place (see figure 6-61).
 14. Gently insert the replacement head into the vacant slot in the print block, and push the print-head driver card into its socket.

Note: Make sure to insert the head with the driver card facing its socket, in the rear of the print block.

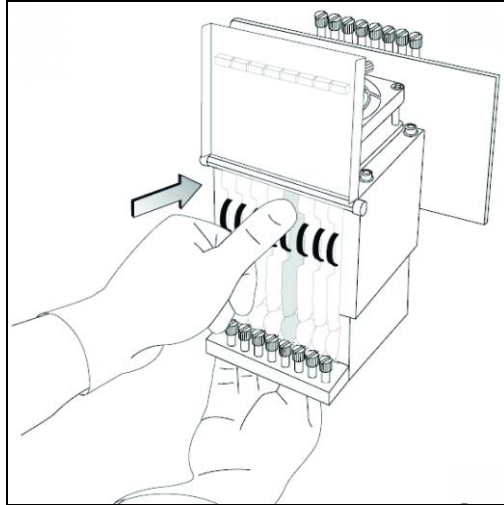

Figure 6-63: Inserting the print-head driver card into its socket

15. Push the head up until you hear it click into place, in both front and rear holders.

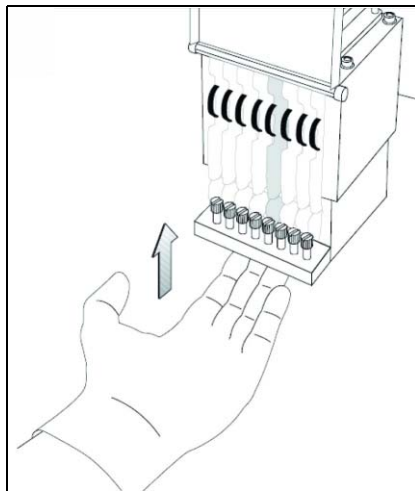

Figure 6-64: Clicking the head into place in the print block

16. Lower the door of the print head compartment, and tighten the screws to lock it in place.
17. Tighten the upper and lower screws that secure the print head in the print block (see figure 6-57 on page 42).

Note: Hand-tighten these screws. Do *not* use a screwdriver or hex (Allen®) key.

18. In the *Replace print heads* screen, select the check box to confirm that you have replaced the head(s), and click Next.

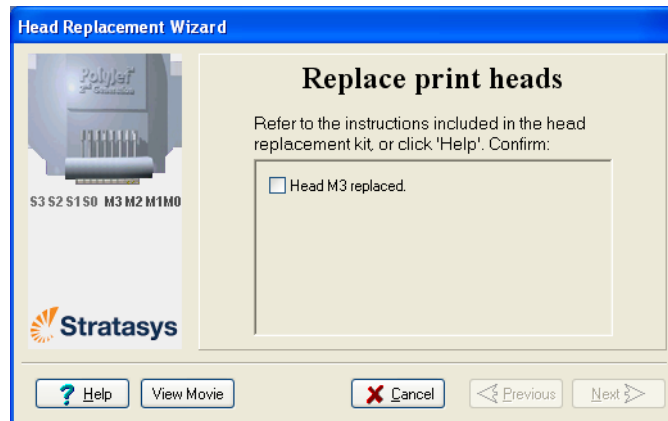

Figure 6-65: *Replace print heads* confirmation screen

19. With your fingers, make sure that the new head is level and even with the other heads.

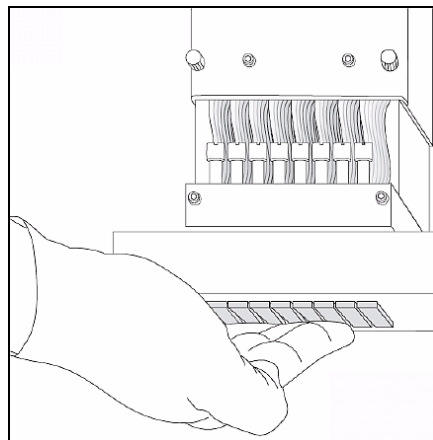

Figure 6-66: Checking the level of the new head

20. Confirm that the heads are level and even by selecting the check box in the following wizard screen, and click Next.

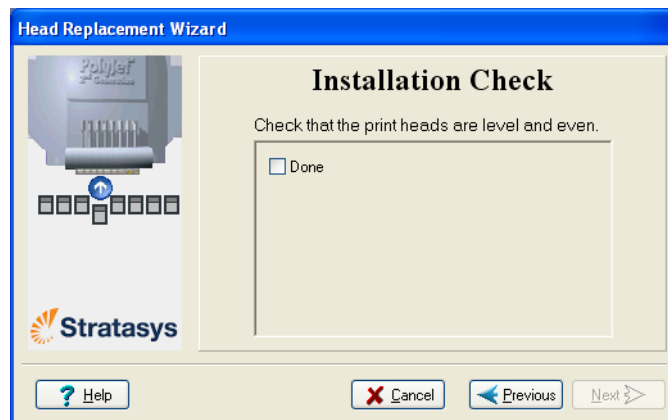

Figure 6-67: Installation-check screen

21. When the following wizard screen appears, remove all tools and objects from the printer and confirm that you have done so.

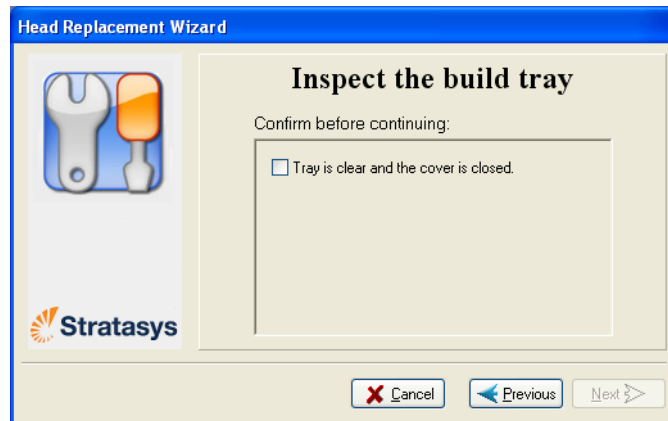

Figure 6-68: Cleared-tray confirmation screen

When you click Next, the print block is heated and filled with printing material.

If installation problems are detected, the wizard alerts you and instructs you how to continue (see "Installation Problems.")

Before using the printer to produce models, you should calibrate the heads and check their alignment.

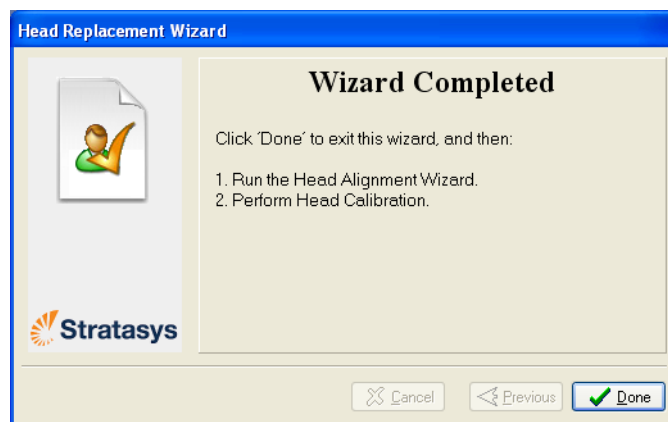

Figure 6-69: Final wizard screen after replacing print heads

- Installation Problems** If the printer detects that there is a problem after you install print heads, relevant warning screens appear.
- If the printer software does not detect the replaced head, the following warning screen appears.



Figure 6-70: Incorrect-installation screen

If this happens:

- a. Open the print head compartment (see figure 6-59 on page 43).
 - b. Re-insert the print-head driver card into its socket (see figure 6-63 on page 45).
 - c. In the wizard screen, select the check box to confirm that you have re-inserted the card, and click **Next**.
- If the replacement head was not factory-calibrated, the following warning screen appears.



Figure 6-71: Invalid-data warning screen

If this happens:

- a. Remove the head and replace it with another one (starting with step 8 on page 42).
- b. In the wizard screen, select the check box to confirm that you have installed another print head, and click **Next**.
- c. Contact your authorized Customer Support center about the unformatted head.

- If the vacuum test is not successful, the replacement head was not sealed properly during installation, and the following warning screen appears.



Figure 6-72: Vacuum-leakage warning screen

If this happens:

- a. Click **Next**.
- b. Follow the instructions on the wizard screens to re-install the head.

Testing and Calibrating the UV Lamps

The effective UV radiation from the lamps used for curing models can change over time. To ensure optimum curing of models during printing, a pop-up message reminds you to test the lamps and calibrate their effective UV radiation after every 300 hours of printing. You do this by running the UV Calibration Wizard.

To measure the UV radiation, you need:

- TOL-03003-S (UV sensor and cable, supplied with the printer)
or—
- a stand-alone UV radiation meter, approved for use with the printer

The wizard compares the measured radiation to the recommended radiation level for each of the lamps, at each printing mode—High Speed, High Quality and Digital Material.

When calibrating the lamps, the wizard attempts to adjust the radiation level, if necessary.

- If the reading is within the acceptable range, the wizard continues to the next phase.
- If further adjustment is necessary, the current phase is repeated.
- If the UV radiation is too low to be properly adjusted, the wizard continues to the next phase, but the final wizard screen indicates that the lamp’s radiation for the printing mode is unacceptable.



Before testing and calibrating the UV lamps:

- Make sure the glass lens on each of the UV lamps is clean. For easy access, run the Head Cleaning Wizard, and use the special cleaning pad supplied.
- Make sure that the glass over the UV radiation sensor is clean.

To test and calibrate UV lamp radiation:

1. Start the UV Calibration Wizard from the *Options* menu (see figure 6-27 on page 6-25).
2. In the following screen, select **Calibrate UV Intensity** to adjust the lamp’s radiation level to the acceptable range.

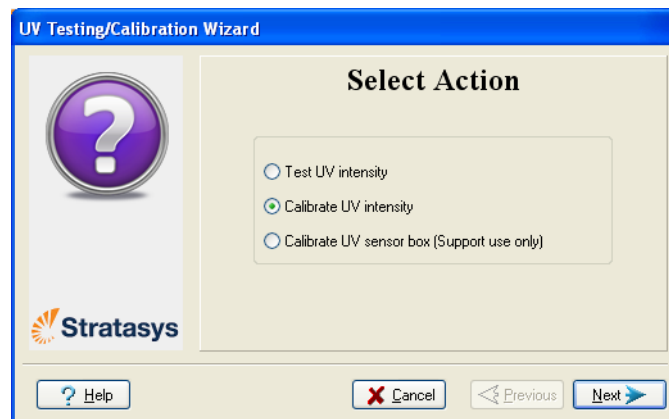

Figure 6-73: UV Test/Calibration selection

3. In the following screen, select the UV sensor and measuring device to be used.

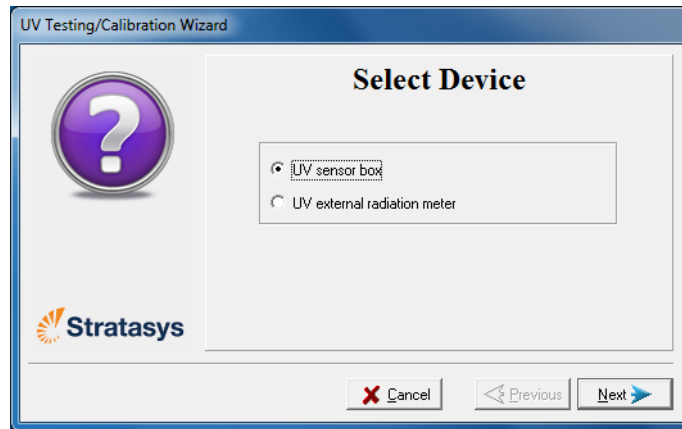

Figure 6-74: UV device selection



UV Measuring Device

When you use UV sensor TOL-03003-S, you connect it to the printer. The wizard automatically measures and calibrates the UV radiation.

If you use a stand-alone UV radiation meter, you need to manually enter the readings from the meter in the wizard screens.

4. Make sure that the build tray is clear (empty), confirm this in the wizard screen and click Next.

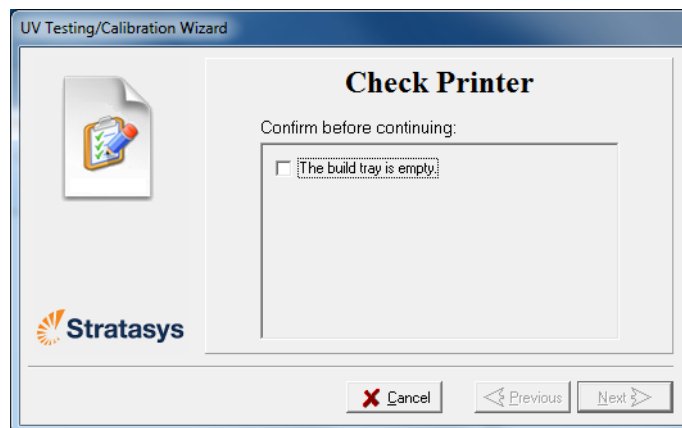

Figure 6-75: Printer preparation

- When using UV sensor TOL-03003-S, continue with “UV sensor connected to printer,” below.
- When using a stand-alone radiation meter, continue with “External UV meter” on page 54.

The following steps apply when using the Stratasys UV sensor that you connect to the printer. They do not apply when using a stand-alone UV radiation measuring device.

- UV sensor connected to printer
1. Adjust the wizard for the sensitivity of the UV sensor by entering the CF number that appears on the sensor's label.

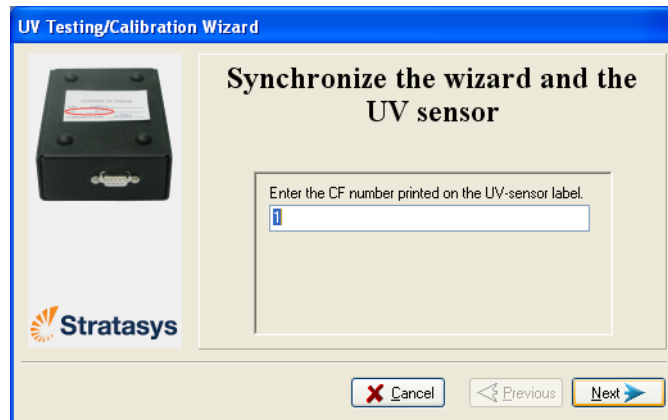

Figure 6-76: UV sensor synchronization



Figure 6-77: Label on the bottom of the UV sensor

The build tray lowers so you can connect the UV sensor.



Figure 6-78: UV sensor connector

2. Connect the UV sensor cable to the connector in the printer.

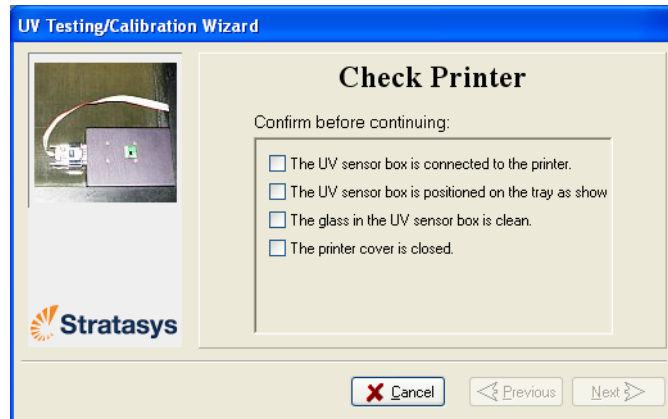

Figure 6-79: Sensor preparation

3. Confirm the items listed in the wizard screen and click Next.

Continue with "UV measurement" on page 55.

External UV meter The following steps apply when using a stand-alone UV meter. They do not apply when using the Stratasys UV sensor connected to the printer.

1. When the following screen appears, open the printer and place the UV sensor at the rear edge of the tray, in the center.

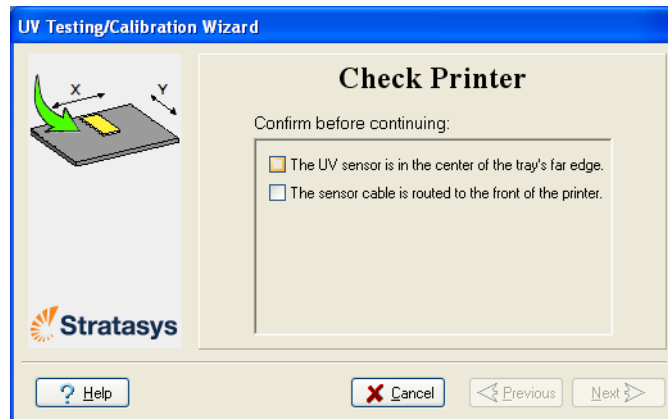

Figure 6-80: Sensor placement screen

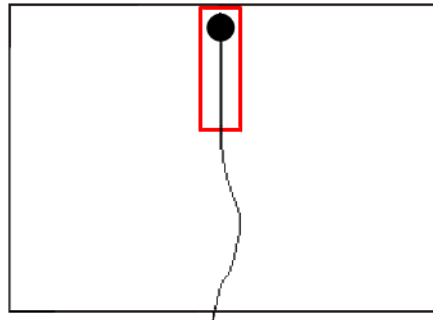

Figure 6-81: Correct UV-sensor placement

2. Lead the cable out of the printer so that you can close the printer, and make sure that the cable will not interfere with the moving print block.
3. Close the printer, while checking that the sensor does not move out of position.
4. Set the UV meter to measure mJ/cm².
5. Set the range on the meter to 2,000.
6. Connect the cable from the sensor to the UV meter.
7. Turn on the UV meter, and wait until "0 0 0.0" appears on the display.
8. In the wizard screen, confirm that the sensor is positioned correctly, and click Next.

Continue with "UV measurement" on page 55.

UV measurement The UV lamps power up and stabilize. (This takes several minutes.) Then, the print block passes over the sensor and the wizard compares the measured radiation to the recommended level for each UV lamp and printing mode. During this process, which takes 20–40 minutes, you need to monitor the progress as displayed in the wizard screen.

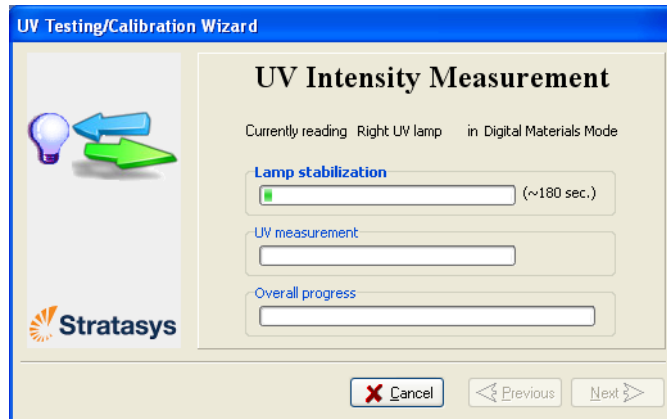

Figure 6-82: UV measurement progress

- When using a stand-alone radiation meter, reset the meter and enter the reading (measurement) when you are prompted to do so.

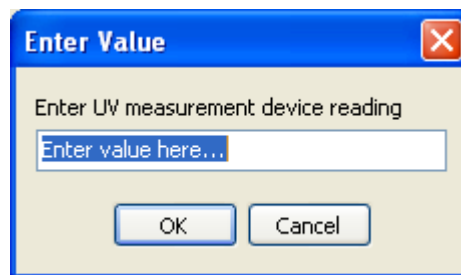

Figure 6-83: UV measurement dialog box

If the UV level measured is not acceptable, the wizard calibrates the UV lamp by adjusting the current supplied to it, and then tests it again.

When all UV tests have finished, the results are displayed, showing the condition of the lamps after calibration (see figure 6-84).

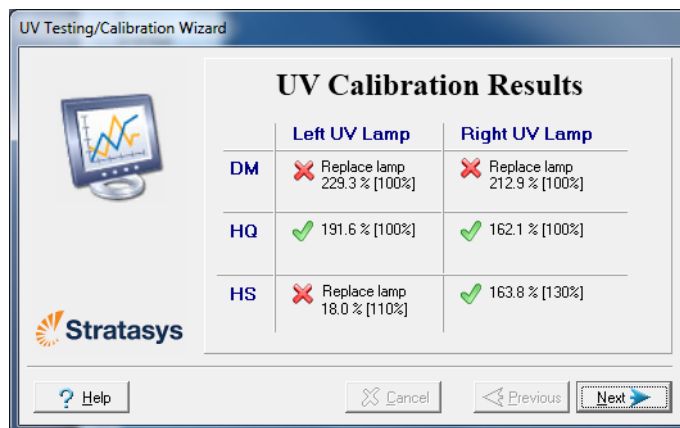

Figure 6-84: Results and condition of UV lamps after calibration

After examining the UV calibration results:

1. Click Next.
2. Remove the UV sensor and close the printer cover. After confirming the items listed in the wizard screen, click Next.

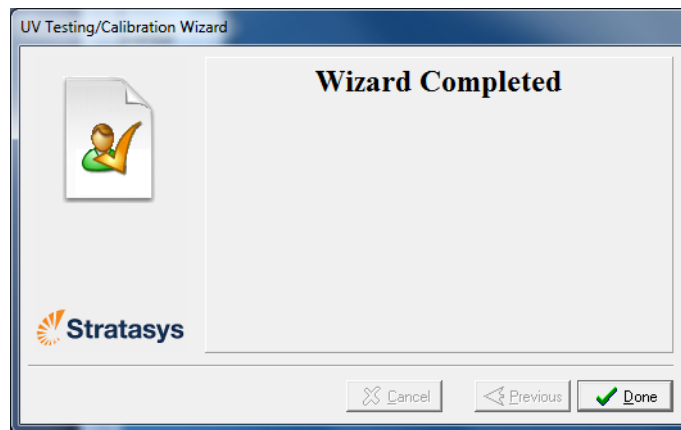

Figure 6-85: Final UV Calibration Wizard screen

Calibrating the Load Cells

Load cells are sensors that measure the weight of the material cartridges and the waste container in the printer. It is important that you periodically check that the weight measurements are accurate, both for convenience and to prevent unnecessary waste of printing materials. It is recommended that you calibrate the load cells once a month.

To calibrate load cells:

1. Start the Load Cell Calibration wizard from the *Options* menu (see figure 6-27 on page 25).
2. Select one or more load cells that you want to calibrate, and click Next.

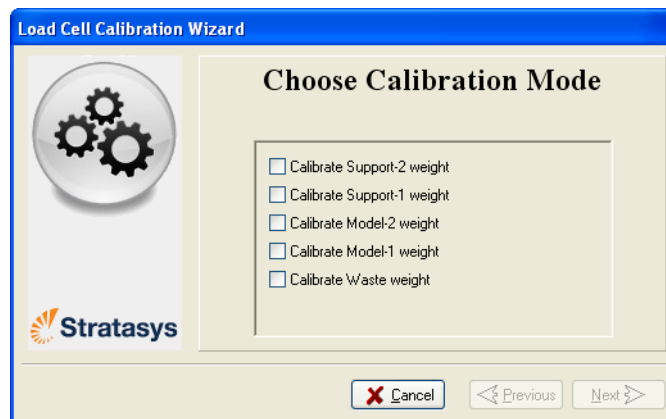

Figure 6-86: Load cell selection

- Remove the cartridge or container, as instructed by the wizard, confirm this in the wizard screen, and click Next.



Figure 6-87: Confirmation of cartridge removal

- In the next wizard screen, observe the numbers and wait until the level is relatively stable—two units above or below the average level shown.



Figure 6-88: Level stabilization

- Select the check box, and click Next.
If you need to calibrate more than one load cell, the next calibration screen appears. Repeat steps 4 and 5 until all of the load cells are calibrated.
- Click Done in the final wizard screen.



Figure 6-89: Final wizard screen

Replacing the Odor Filter

If the printer exhaust is not connected to an external ventilation system, a built-in activated-carbon filter removes odors from printing materials. This filter should be replaced regularly (as necessary) to keep your working environment pleasant. This is normally done during the preventive-maintenance service visit.

Replacing the UV Lamps

The UV lamps used for curing models have a long, but limited, working life. The Stratasys service engineer tests their effectiveness during regular maintenance checks, and replaces them, if necessary. You can test and adjust their effective power with the UV Calibration wizard (see “Testing and Calibrating the UV Lamps” on page 50. If you need to replace a UV lamp, follow these instructions:

1. Make sure the printer is in *offline* mode.



Figure 6-90: Offline mode indicator (red)

The *online/offline* button at the bottom of the printer interface should be red. If not, click it to switch the printer to *offline* mode.



WARNING: Before continuing, make sure that the safety interlock is not defeated, and that the lamp is not hot.

2. Start the UV Lamp Replacement wizard from the *Options* menu (see figure 6-27 on page 25).
3. Make sure that the build tray is empty, and confirm this in the wizard screen. Then, close the printer cover and click *Next*.



Figure 6-91: “Empty tray” confirmation screen

The axes move to the “home” position.

- Select the UV lamp(s) to be replaced and click Next.

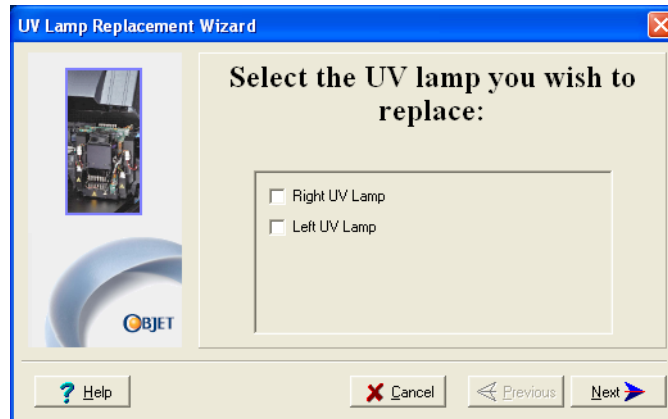

Figure 6-92: UV lamp selection screen

- Disconnect the UV-lamp power connector and the UV heat fuse connector.

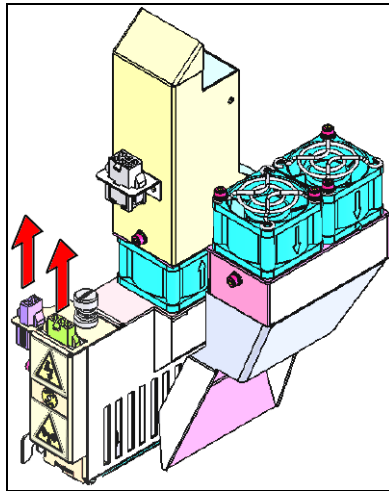

Figure 6-93: Disconnecting the UV lamp

Note: Do *not* disconnect the power connection to the cooling fans.

- Loosen the screw securing the UV lamp cover (A), and pull the cover up (B), then out (C).

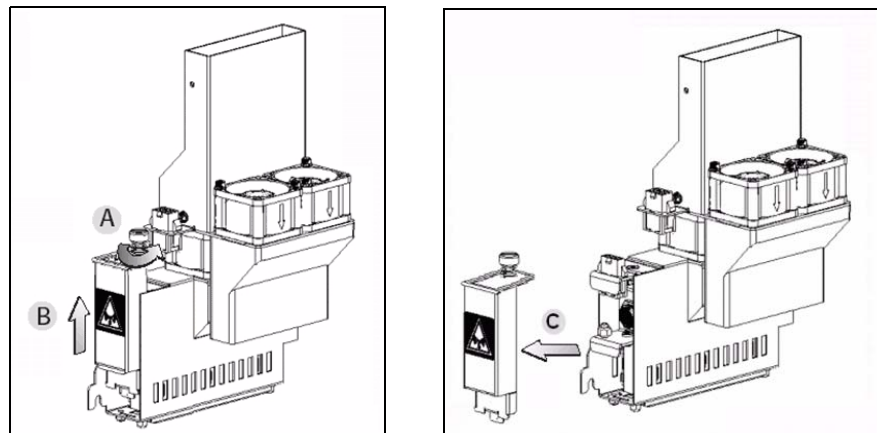

Figure 6-94: Removing the UV lamp cover

7. Pull the lamp reflector out of the print block.

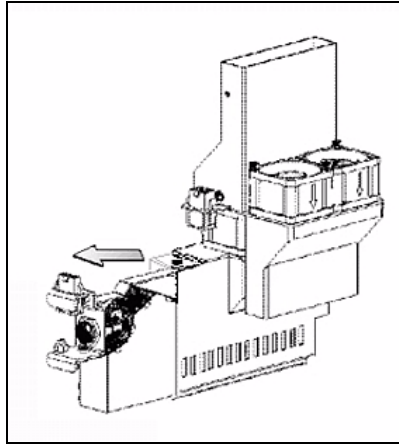

Figure 6-95: Removing the UV lamp reflector

8. Inspect the new lamp reflector, and make sure that a black strip is attached to the inside of it. If not, install one—on the side of the reflector *opposite* (not next to) the print block.

Note: Extra black strips are included in the printer Start-up Kit. If necessary, you can remove the black strip from the old reflector and install it in the new reflector (as long as the black paint has not faded).

9. Discard the old reflector and lamp.



Dispose of the used UV lamp in accordance with environmental and safety requirements.



WARNING: Broken lamp hazard.

UV lamps contain mercury. Deal with broken lamps with caution.

- Ventilate the room thoroughly.
- Use protective gloves when collecting mercury and lamp components.
- Remove spilled mercury with a method that prevents the generation of mercury vapor, such as a syringe, packing tape or paper.
- Place the broken lamp, mercury and contaminated materials in an air-tight, non-metallic container.

10. Insert the new UV lamp/reflector unit into the housing next to the print block.

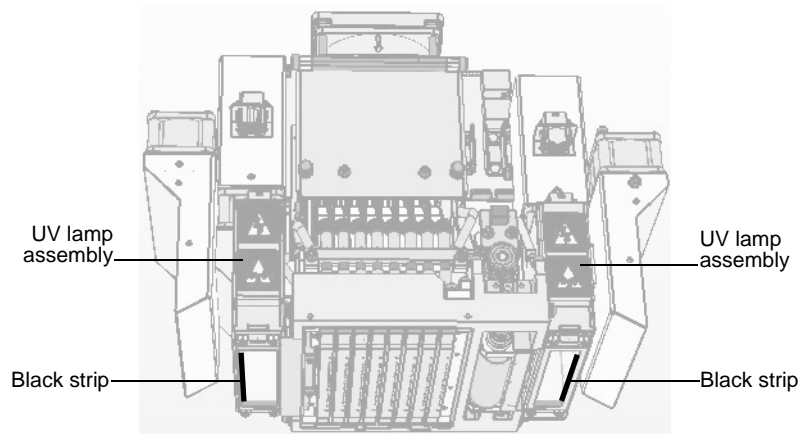

Figure 6-96: Print block and UV lamp assembly, showing correct placement of black strip

11. Replace the lamp cover by inserting it into the slot on the bottom of the housing, and tighten the securing screw on top.

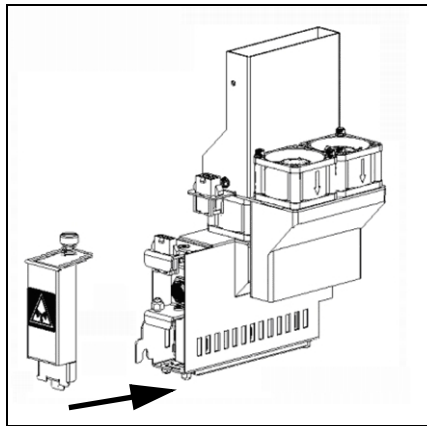

Figure 6-97: Replacing the lamp cover

12. Reconnect the power and heat fuse connectors.

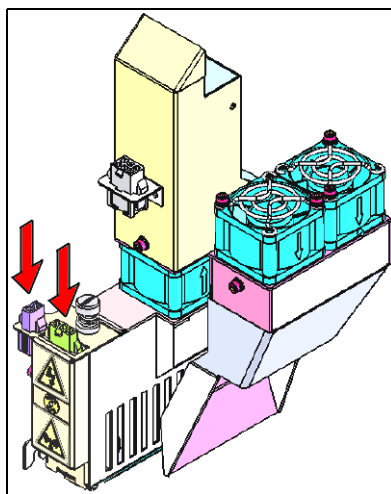

Figure 6-98: Connecting the UV lamp

13. In the wizard screen, confirm that you have replaced the lamp(s) and that the black strip is attached, then click Next.

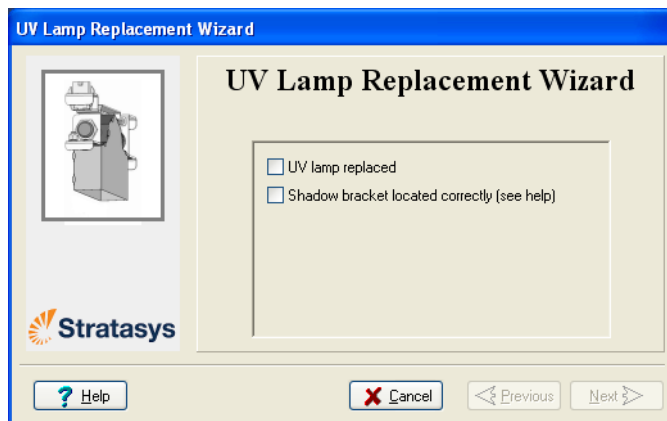

Figure 6-99: UV-installation confirmation screen

The wizard operates the lamps and checks if their power is within the acceptable range for each printing mode. (The mode currently being checked appears in the lower-left corner of the printer interface.)

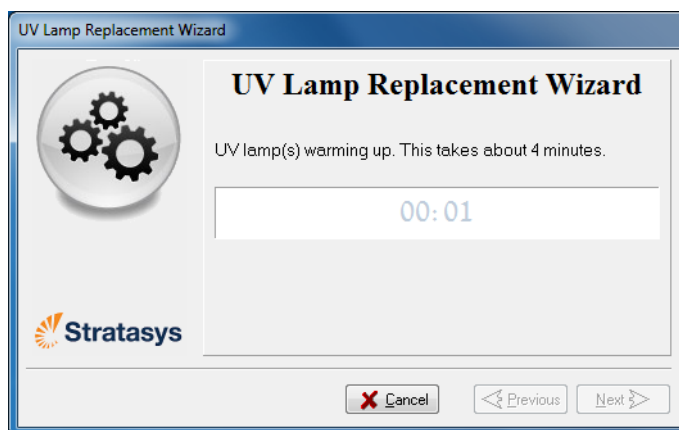

Figure 6-100: Status screen during UV lamp check

14. After replacing a UV lamp, it is recommended that you calibrate its power for the various printing modes. The next screen allows you to continue to the UV Calibration wizard (see “Testing and Calibrating the UV Lamps” on page 50).

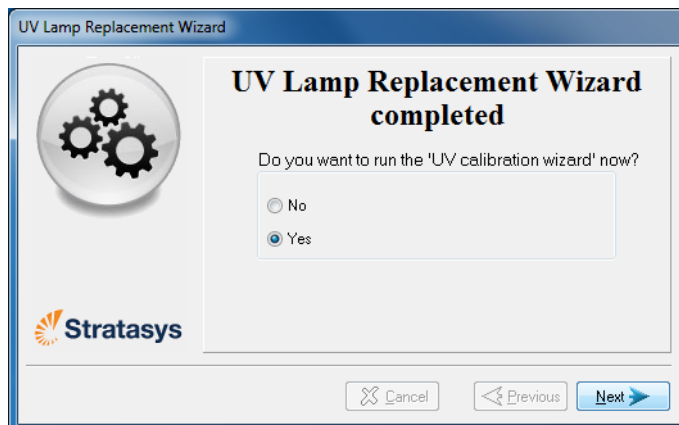

Figure 6-101: Final wizard screen

Built-in Tests

The printer application contains a suite of tests for regularly checking the hardware and software, and for troubleshooting. You can configure basic communications and environment tests to run automatically, when the Connex software opens. In addition, you can run a more comprehensive set of tests before processing a print job, as a system check, to ensure optimum printing results.

Because running the tests effects the operation of the printer, you can only open the Built-in Tests interface when the system is not printing.

The test suite features:

- The organization of printing-related tasks in categories:
 - Communications
 - Data cards
 - Temperatures
 - Voltages
 - Encoder repeatability
 - Print-head heating
 - Print-head filling
- A clear display of test results and the source of any failures, enabling you to determine if printing is possible or worthwhile.
- The ability to monitor test results for specific components.
- Troubleshooting tips.

Running these tests can help identify problems in the printer hardware and software. A large number of hardware defects (or near-defects) warns you of possible printing problems, either for current or future jobs.



Stratasys recommends running the built-in tests in the following cases:

- as a routine test, once every two weeks
- as a system check, before major (long) jobs
- as needed, for troubleshooting

Accessing Built-in Tests

To open the Built-in Tests screen, do one of the following:

- From the *Options* menu, select Built-In Tests.
- Press Ctrl+Alt+B.

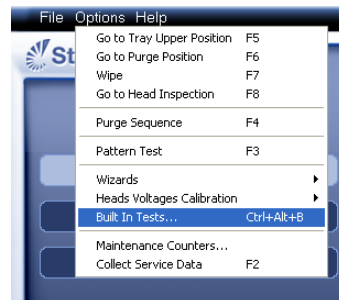

Figure 6-102: Selecting *Built-In Tests* from the *Options* menu

Test Interface The *Built In Tests* screen lists pre-configured tests, grouped by component categories. In this screen, you select and run tests, and the results are displayed.

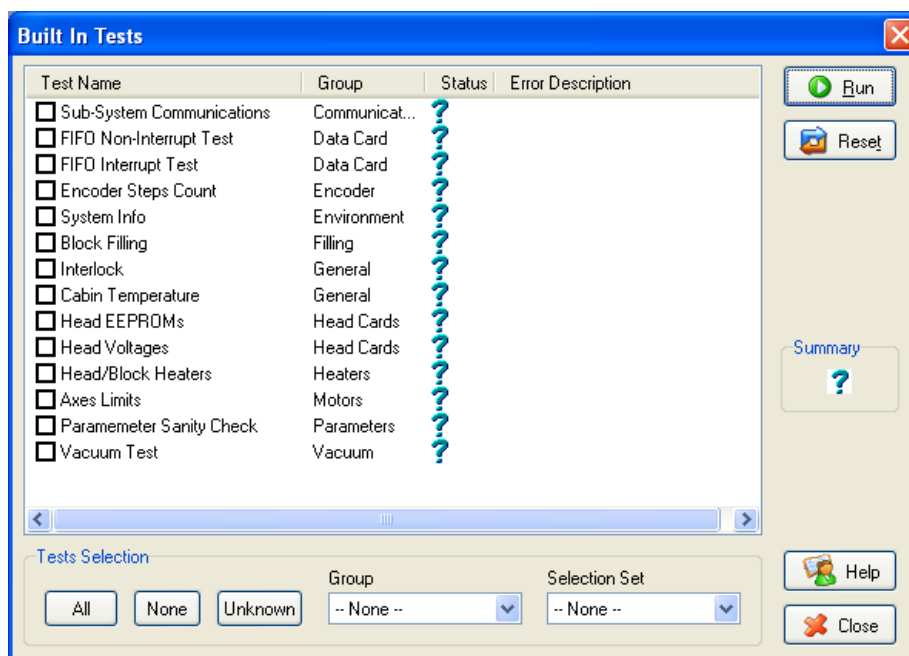

Figure 6-103: *Built In Tests* screen

Test List Test Name

This column lists all of the tests, together with selection check boxes.

Click the check boxes to select the tests you want to run. To remove a selection, click the check box again. To quickly select all of the tests in a component category, use the *Group* drop-down list at the bottom of the screen.



Group

This column shows the component categories for each test.

This tells you which tests are run when selecting a category from the *Group* drop-down list at the bottom of the screen.

Status

This column shows the results of each test after you run it:

-  Test successfully completed.
-  Test failed.
-  Unknown results. (The test has not been run yet.)

Test Selection Area In the *Test Selection* area, at the bottom of the screen, you can quickly select or de-select tests by their characteristics:

All	Click to select all of the tests in the list.
None	Click to de-select all of the tests in the list.
Unknown	Click to select all test that have not been run yet (Status = ?).
Group	Use this menu to select tests by component category.
Selection Set	Use this menu to select a pre-configured set of tests to run at specified times (computer startup, before printing, etc.).

Running Tests To run the selected tests:

- Click .



After you run a test, the *Save* and *View* command buttons are added to the *Built In Tests* screen (see below).

Test Results To save and view a report of all of the tests:

- Use the *Save* and *View* command buttons (see below).

Command Buttons You click the command buttons, on the right side of the screen, to perform the following operations:

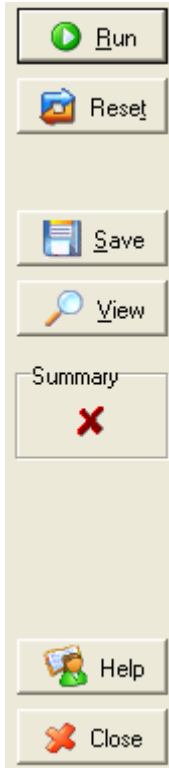

Run

Click to run the selected tests.

Reset

Click to clear previously run tests. This returns the status of each test to *Unknown (?)*.

Save

Click to save a report that summarizes the tests run. The report is saved as an HTML file. You can save any number of reports for the tests you run; the name of the file saved is *BITReport [date][time].htm*. By default, these files are saved in the Connex installation folder, but you can save it in any other folder.



View

Click to display the latest test report that you saved. (You can view other test reports by opening the relevant files in your Web browser. To do so, open Windows Explorer, and double click the *BITReport* file.)

Close

Click to close the *Built-in Tests* screen.

Summary On the right side of the screen, a symbol represents the combined results of all the tests run, using the symbols from the *Status* column.

-  All tests successfully completed.
-  At least one test failed.
-  Not all tests performed.

Test Descriptions and Troubleshooting The following table lists the name of each test in the Built-in Tests suite, together with its description and a possible reason for its failure. If you need assistance, contact your Stratasy's service provider.

Test Name	Description	Possible Reason for Failure
Sub-System Communication	Tests communications between Eden components.	<ul style="list-style-type: none"> • Disconnected communications cable. • Faulty cable.
FIFO Non-Interrupt/ FIFO Interrupt	<ul style="list-style-type: none"> • Tests the data queue in the DATA PCI card. • Tests the Windows interrupt. 	<ul style="list-style-type: none"> • If both FIFO tests fail: Faulty DATA_PCI card. • If only the FIFO Interrupt test fails: Faulty Windows interrupt.
Encoder	Tests the encoder's reliability by comparing readings from multiple runs along the X-axis.	Faulty encoder.
System Info	Compares the following parameter values with the minimum requirements. <ul style="list-style-type: none"> • physical memory • available memory • free space on disk • monitor resolution 	Failure of RAM memory allocation in the printer computer.
RFID	Verifies the presence of RFID tags on all loaded material cartridges, and tests them by writing to and reading from each one.	<ul style="list-style-type: none"> • Faulty RFID reader. • Faulty RFID reader power supply. • Faulty or misaligned RFID tag. • High level of electromagnetic noise around the RFID tag.
System Voltages	Checks if the following voltages are within 5% of the required voltage: <ul style="list-style-type: none"> • 40V to the print heads by the VPP power supply • 12V to the height thermistors by the VDD power supply 	<ul style="list-style-type: none"> • VPP power supply: Faulty head drive(s). • VDD power supply: Faulty height thermistor(s).
Block Filling	Analyzes the thermistor readings when the block is full and when it is empty.	Faulty thermistor.
Interlock	Tests the interlock in the printer cover.	<ul style="list-style-type: none"> • Failure of interlock mechanism. • Faulty latch. • Disconnected cable.
Cabin Temperature	Tests the temperature level in the build-tray area.	Faulty temperature sensor (OHDB).
Head EEPROM	Tests the read/write capabilities of the print-head driver cards.	Faulty print-head driver card(s).
Head Voltage	Checks the control of voltages supplied to the print heads.	Faulty print-head driver card(s).
Head/Block Heaters	Tests the heaters in the print heads and in the print-block body.	Faulty heaters or thermistors.
UV Lamps	Tests each UV lamp at the High Quality power level.	<ul style="list-style-type: none"> • Faulty UV lamp. • Faulty UV power supply. • Disconnected UV cable.
Axes Limit	Tests the hardware and software limits of all axes.	<ul style="list-style-type: none"> • Faulty hardware sensors. • Wrong <i>Max Position</i> parameter.
Parameter Sanity Check	Compares the values of all printer parameters (in cfg files) to the required values.	One or more of the printer parameters is not within the required range. Details appear in the BIT report.
Vacuum	Tests the vacuum level in the print block.	<ul style="list-style-type: none"> • Faulty vacuum sensor. • Vacuum leakage. • Wrong parameters.

Replacing the Waste Container

Printer waste contains partially cured polymeric material, collected during normal operation and maintenance of the printer. For safety and environmental reasons, this material is kept in a special leak-proof, disposable container.

The container has a capacity of 10 kilograms of waste material—usually enough for several months of printer use. The printer application displays a warning message when there are 9 kilograms of material in the container, and stops the printing when the net weight reaches 9.5 kilograms. Above 9 kilograms, the software does not allow you to start a print job (or a printing activity) until you replace the waste container. You can monitor the weight of the waste container in the *Maintenance* screen of the printer interface. You can also visually inspect the level of waste in the container. (To access it, see page 69.)

To monitor the waste weight (and other indicators) in the printer:

- In the main printer interface screen, click the display toggle to view the printer indicators.



Figure 6-104: Printer interface, showing waste weight (red background indicates operator alert)

The waste container consists of a plastic container inside a cardboard box. You typically dispose of the entire waste container—including the box. Therefore, you must assemble a new box and insert a new plastic container before you can install it in the printer.



Replacement boxes, plastic containers, and sealing caps are supplied in the Connex printer start-up kit and in the preventive-maintenance kit.

To prepare a new waste container:

1. Assemble the cardboard box, making sure to punch out the perforated sections.
2. Place a new plastic container into the box.
Note: Do not close the box until you connect the waste drain tube from the printer.

To replace the waste container:

1. Open the front doors of the printer.



Figure 6-105: Accessing the waste container

2. Carefully slide out the waste container to remove it from the printer.
3. Place the new waste container next to the full container.
4. Unscrew the cap securing the waste drain tube and connect it to the new container.
5. Close the full container with the cap supplied with the new waste container.
6. Close the new waste-container box, using tape to hold it closed.
7. Position the waste container under the printer, on the load cells.
 - The container should be on the extreme right side of the compartment.
 - Make sure that the waste drain tube is not crimped and that it is not pinched by the container.
8. Close the waste compartment door.



Dispose of the full waste container in accordance with environmental and safety requirements.

Cleaning the Exterior Panels The painted exterior plastic panels of Connex 3D printers have a durable finish, offering excellent chemical resistance to common cleaning materials. Follow the recommendations below when cleaning these areas of the printer.

Acceptable Cleaning Agents

- mild soap solution
- common household cleaners and window cleaners
- common commercial and industrial detergents, 5% solution in water
- alcohol (ethanol, isopropanol), 10% to 40% solution in water

Wipe the exterior of the printer, using a soft cloth moistened with the cleaning solution.

Unacceptable Materials

- industrial solvents
- cleaning agents containing hydrocarbons, ketones, esters and lacquer thinners
- spray disinfectants
- abrasives and agents which could wear away the panel finish

7

Handling Printed Models

Removing Models After Printing.....	2
Removing the Support Material.....	2
Post-Printing Treatment for Models Printed with Objet VeroClear.....	4
Storing Models.....	5

Removing Models After Printing

After printing models, you should allow them to cool as much as possible before handling them. If additional models do not have to be produced on the printer, it is best to let the printed models cool in the printer, with the cover closed, as long as possible.

If the printer must be used to produce additional models as soon as possible:

1. Let the printed models cool on the build tray for at least 10 minutes.
2. Very carefully, remove the models from the tray with a scraper or spatula (supplied in the tool kit), taking care not to pry or bend the model.



WARNING: Wear protective gloves when handling printed models before they are washed.

3. Place the models on a flat surface, and cover them with a cardboard box or paper hood.
This allows the models to cool slowly and evenly.
4. Let the models cool for several hours.

Removing the Support Material

After printed models have cooled, the support material must be removed. This can be done by different methods, depending on the size of the model, how delicate it is, the amount and location of the support material, and other factors. Use the following methods as a guide, and adapt them (or a combination of them) for finishing the models you are handling.

Removing Excess
Support Material by
Hand

While wearing protective gloves, break away excess support material on the outside of the model. For delicate models, use a toothpick, pin or small brush after dipping the model in water.

Removing Support
Material with Water
Pressure

For most models, the most efficient way to remove support material is by using a high-pressure water jet. One suitable system is the Balco WaterJet cleaning unit. This device is marketed by Stratatsys.

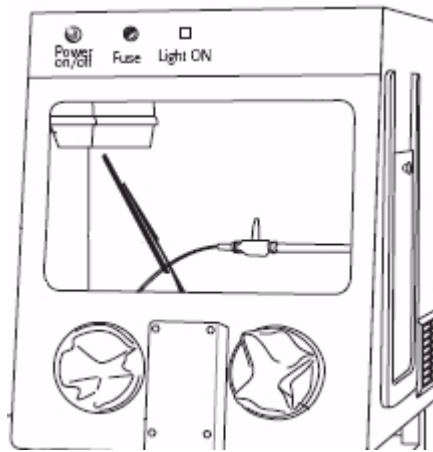

Figure 7-1: Balco WaterJet Cleaning Unit

To clean a model using this device, you place it in the chamber, and you manipulate it and the jet using the built-in, waterproof sleeves. A pump turns ordinary tap water into a high-pressure jet, and a wiper keeps the window clear.



Use caution when cleaning delicate models with high-pressure water systems.

Removing Support Material with Caustic Soda

Soak models in a 1-percent solution of caustic soda (sodium hydroxide) to remove support material from difficult-to-reach areas and to give the model a smooth, clean finish. The amount of time you soak the model in the solution depends on how delicate it is and how much support material needs to be removed, but it is typically between half-an-hour and several hours. In any case, you should remove as much support material as possible before the caustic soda treatment, and rinse the model thoroughly (with a water jet) afterwards.



WARNING: Caustic soda may cause chemical burns, scarring and blindness. Mixing it with water generates heat that could ignite other materials. Never pour water into a caustic soda solution. When diluting the solution, always add caustic soda to water. Take adequate safety precautions; always use nitrile gloves when handling caustic soda and models soaked in it.

Post-Printing Treatment for Models Printed with Objet VeroClear

Models made with Objet VeroClear (RGD810) have a slight yellow tint when removed from the printer. This is especially true for models printed with a glossy finish. The yellow tint fades naturally over time, but you can greatly accelerate this process by using a suitable photobleaching treatment.

As a rule, best clarity is achieved when parts are printed with a matte finish, and treated as explained below.

Photobleaching models involves exposing them to light. To achieve highly controlled and predictable results, a professional illumination chamber is recommended. However, adequate results may be obtained using ordinary desk lamps fitted with suitable fluorescent elements.



Figure 7-2: Illumination chamber



Figure 7-3: Desk lamps

Photo-Bleaching Instructions

Follow these instructions for photobleaching printed models.

- The fluorescent lamps should be rated 45W, 6500K.
- When using desk lamps, place the models in a container lined with aluminum foil. Use at least two lamps, more when treating models in a large container.
- Arrange the models with enough space between them to allow light to reach all sides of each model.
- Verify that the ambient temperature around the models is approximately 40°C (104°F). Higher temperatures may cause model distortion; lower temperatures may not produce satisfactory results. When using desk lamps, you can achieve the required temperature by positioning the lamps approximately 10 cm (4 in.) above the models.
- Inspect the models after six hours of treatment.
 - For parts with a matte finish, this should be enough. Polish and lacquer the parts.
 - For parts with a glossy finish, continue the photobleaching treatment for up to 18 hours more.

In Stratays laboratories, there was a tint reduction of approximately 70% within six hours. After 24 hours, tint was reduced by approximately 90%.



More information about this treatment is available in the application note *VeroClear RGD810 Model Material*.

Storing Models

Models are cured as they are printed, making them safe and stable for a long time. However, proper storage conditions are necessary to prevent deforming.

- Keep printed models at room temperature and in a low-humidity environment.
- Do not expose models to direct sunlight and other heat sources.