

# Engineering Excellence

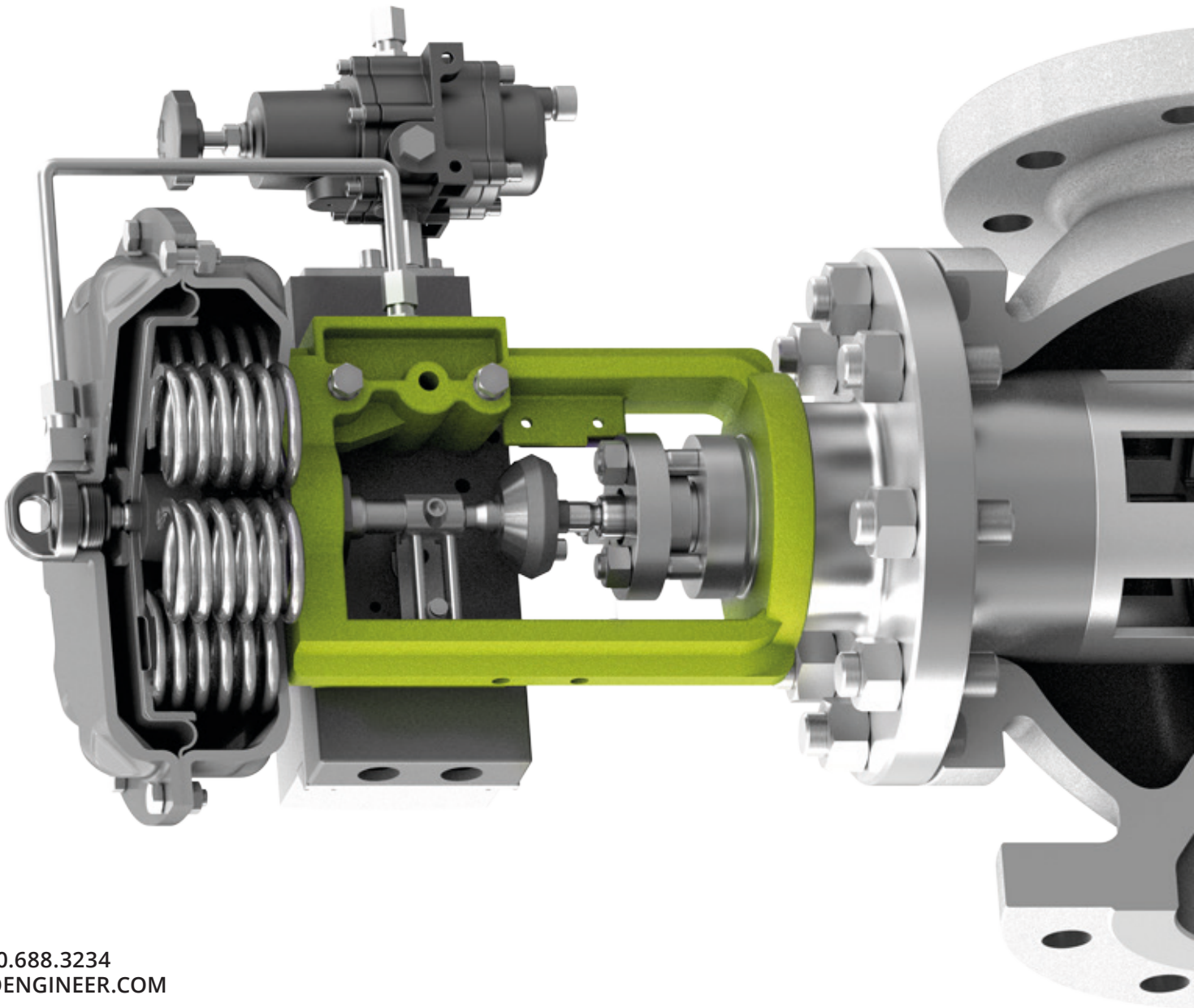



# Ready to Level Up?

In an era where standing still means falling behind, product developers held back by outdated technology lose time, talent, and market share. Take control of your company's future and innovate with GoEngineer.

Forge your path forward with complete digital engineering & manufacturing solutions: powerful SOLIDWORKS & CATIA CAD, Cadence EDA, model-based systems engineering, virtual prototyping of both product and production, manufacturing operations management, production-scale polymer & metal 3D printing systems, and so much more. GoEngineer is your partner in engineering excellence.

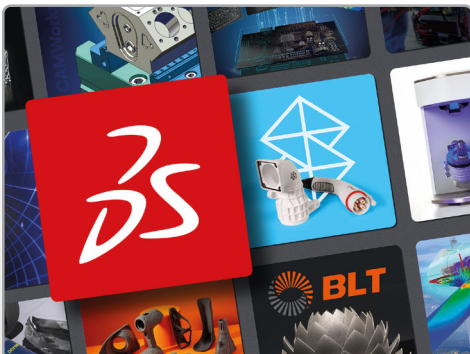
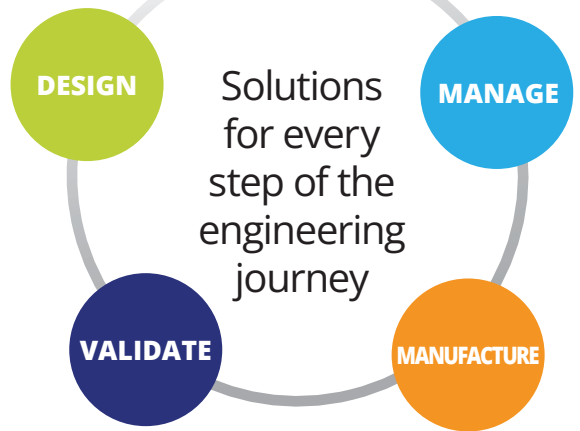

## Best In Class

### SOLUTION PORTFOLIO

Explore a holistic portfolio of industry-leading software, hardware, services, and training for maximum business impact.



## 300+ Engineers

### DEDICATED TO YOUR SUCCESS

Grow with our team of application engineers, available for consulting, implementations, training, tech support, and more.



## 60+ Offices

### ACROSS NORTH AMERICA

GoEngineer offices are innovation hubs in their regions, with many locations serving customers for over 20 years.

trusted by industry leaders

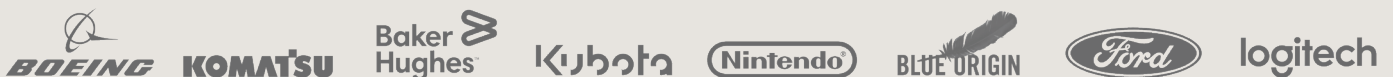



# Why GoEngineer?

For over 40 years, GoEngineer has partnered with companies to transform ideas into impact. With tens of thousands of customers across machine design, high-tech, medical, energy, and other industries, collaboration and partnership are at the heart of everything we do.

When you work with GoEngineer, you can expect our team to act as a strategic extension of your own. Whether you're implementing new technologies, troubleshooting with tech support, ordering 3D printed parts, or managing complex data projects, our certified experts deliver the dependable support you need to innovate with confidence.



**#1 PARTNER**  
DASSAULT SYSTÈMES  
& STRATASYS

**150,000+**  
YOUTUBE  
SUBSCRIBERS

**90,000+**  
SOLIDWORKS AND  
CATIA USERS

**24**  
3D PRINTING LABS  
ACROSS NAM

**100+**  
EXPERT TRAINING  
COURSES



We're extremely grateful to have GoEngineer as the service vendor for our Stratasys machine! They have been nothing short of excellent.

**ALEX MAZHARI**  
ENGINEERING MANAGER  
**NASA**



Many providers we've worked with propose a solution but hold onto information to keep us coming back. GoEngineer stood apart for their willingness to teach us how to fish.

**PETE ROBINSON**  
ENGINEERING SYSTEMS MANAGER  
**weather guard**

## Our story

GoEngineer was founded during the CAD revolution, when an ambitious engineering student put in a bid to implement a CAD system for the local power utility, **and won.**

How did a kid in blue jeans win over salesmen in suits? Instead of pitching, he built. Instead of selling, he solved. He delivered a completely tailored CAD application and demoed the exact workflows power and light engineers would rely on. His demo wasn't a sales pitch, it was a testament to what was possible when you deeply understood technology, and cared about a customers needs.

That spirit still drives us today.



# Software Solutions

## Our Partners



## Our Solutions



### Product Definition & Systems Design

- Multi-disciplinary CAD (MCAD/ECAD)
- Model-based systems engineering (MBSE)
- Requirements management
- Knowledge-based engineering

### Industry Trends

- Model-based enterprise
- Generative design
- AI-driven modeling
- Cloud-native collaboration



### Simulation & Virtual Testing

- Structural simulation (FEA)
- Fatigue & durability
- Multi-body dynamics
- Computational fluid dynamics (CFD)
- Electromagnetic simulation

### Industry Trends

- Product virtual prototyping
- Simulation-driven design
- AI-driven simulation
- Simulation cloud compute



### Digital Manufacturing & Operations

- NC & robot programming (CAM)
- Factory & process planning
- Bill-of-materials management
- Manufacturing execution & ops (MES/MOM)
- Advanced production scheduling (APS)
- Sales & operations planning (S&OP)
- Enterprise resource planning (ERP)

### Industry Trends

- Factory digital twin
- Virtual commissioning
- Closed-loop manufacturing

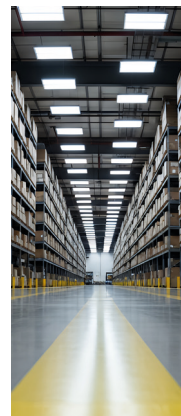

### Lifecycle & Data Management

- Data management & document control
- Change & configuration management
- Product & portfolio management (PPM)
- Quality & compliance management
- Configure, price, quote (CPQ)
- Intelligent sourcing & parts standardization
- Service lifecycle management (SLM)

### Industry Trends

- Single source of truth
- Secure, cloud-native PDM & PLM
- Data-driven decision making



# Mechanical Design & Engineering



- Design
- Electrical
- Composer
- Inspection
- MDB
- Visualize
- CAM
- Simulation
- Flow Simulation
- Plastics
- Product data management (PDM)
- Manage



- Design & Engineering
- 3DEXPERIENCE SOLIDWORKS
  - 3DEXPERIENCE CATIA
  - 3DEXPERIENCE GENERATIVE DESIGN
  - 3DEXPERIENCE DraftSight
  - SOLIDWORKS xDesign
- Advanced Simulation
- 3DEXPERIENCE STRUCTURAL
  - 3DEXPERIENCE FLUIDS
  - 3DEXPERIENCE ELECTROMAGNETICS
  - 3DEXPERIENCE PLASTICS

- Manufacturing Engineering & Ops
- 3DEXPERIENCE VIRTUAL FACTORY
  - 3DEXPERIENCE NC PROGRAMMING
  - 3DEXPERIENCE ROBOTICS
  - 3DEXPERIENCE ADDITIVE MANUFACTURING
  - 3DEXPERIENCE FACTORY OPERATIONS
- Data & Lifecycle
- 3DEXPERIENCE cloud product data management (PDM)
  - 3DEXPERIENCE cloud product lifecycle management (PLM)



- CATIA V5 & CATIA V6 (3DEXPERIENCE)
- Buildings & infrastructure
  - Design & styling
  - Electrical & fluid engineering
  - Mechanical engineeringCameo
- Cameo & CATIA Magic: Model-based systems engineering (MBSE)

# Simulation, Manufacturing, Data & Lifecycle



- Abaqus: Structural simulation finite element analysis (FEA)
- CST Studio Suite: Electromagnetic simulation
- PowerFLOW: Computational fluid dynamics (CFD)
- SimPack: Multi-body system dynamics
- wave6 & Manatee: Vibroacoustics
- Isight: Simulation automation
- Cloud-based high performance computing



- DELMIAWorks: Enterprise resource planning (ERP)
- Apriso: Manufacturing operations (MES/MOM)
- Ortems: Planning & scheduling (APS)
- Quintiq: Supply chain & logistics (S&OP)



- Data management
- Project management
- Product management
- CAD & multi-CAD management
- Change management
- Configuration management
- Quality & compliance management



- Intelligent product planning
- AI-driven part sourcing
- Data-driven business analytics

# More Solutions



- SOLIDWORKS CAD/CAM for woodworking industry
- SWOOD design
  - SWOOD CAM
  - SWOOD nesting



- Service lifecycle management (SLM) platform
- Inventory IQ
  - Pricing IQ



- AI-driven simulation
- Cloud simulation
  - Physics AI
  - Engineering AI



- Quality & compliance software for CATIA
- CAVA
  - Q-Checker
  - xCompare



- Design automation & configure, price, quote (CPQ) for SOLIDWORKS
- DriveWorks
  - DriveWorks sales configurator



- Advanced CAM solutions for SOLIDWORKS
- CAMWorks
  - NESTINGWorks



- Printed circuit board (PCB) design (EDA)
- Allegro X
  - OrCAD X



- 3D-to-3D CAD translation
- CADFeature



- 2D Drafting from SOLIDWORKS
- 2D CAD



- Virtual machining solutions
- Eureka g-code
  - Eureka robot

# Hardware Solutions

## Our Partners



## Our Solutions



### 3D Printing Systems

- Fused deposition modeling (FDM)
- PolyJet technology (PJ)
- Metal additive manufacturing
- Stereolithography (SLA)
- Selective laser sintering (SLS)
- Selective absorption fusion (SAF)
- Programmable photopolymerization (P3) (DLP)



### 3D Scanning

- Portable handheld scanning
- Structured light scanning
- Laser-based scanning
- Metrology-grade scanning
- Automated quality control
- Coordinate measuring machines (CMM)
- Long-range LiDAR
- Reverse engineering, metrology, and inspection software

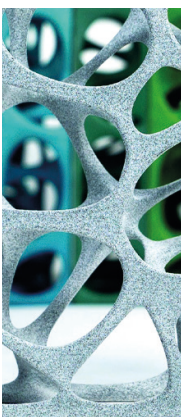

### Post-Processing

- Automated support removal systems
- Resin washing and curing stations
- Surface refinement and finishing equipment
- Powder management and recovery systems
- Vapor smoothing systems
- Automated dyeing and coloring solutions
- Waste disposal systems



### 3D Printing Services

- 100+ material options
- Online quoting
- Rapid prototyping, short-run production, large-format printing
- Full-color & multi-material services
- ITAR registered, ISO 9001:2015, AS90100 certified



## 3D Printers



- FDM industrial 3D printers
- PolyJet multi-material systems
- P3 programmable photopolymerization
- SAF selective absorption fusion
- Stereolithography
- Stratasys materials (thermoplastics and photopolymers)



- SLA 3D printers
- SLS 3D printing systems
- Automated post-processing
- Professional resins & powders (thermoplastics and photopolymers)



- Metal LPBF: (laser powder bed fusion) systems
- Large-format & multi-laser metal printers
- Over 30 metal powder material options



- FDM 3D printers
- Cura: Print preparation software
- Digital Factory: Print management software

## 3D Scanning



- Portable handheld 3D scanners
- Automated quality control
- Coordinate measuring machines
- Scan-to-CAD & inspection software



- Handheld 3D scanners
- Desktop 3D scanner
- Long-range LiDAR
- 3D scanning software



- Geomagic Control X
- Geomagic Design X
- Geomagic for SOLIDWORKS
- Geomagic Wrap

## Software and Services



- GrabCAD Print: Advanced slicing & print management
- GrabCAD Print Pro: Manufacturing accuracy & templates



- Magics: Data preparation & STL editing software
- Build Processor: Machine-specific connectivity
- 3-Matic: Cleanup rough data
- E-Stage: Automatic support generation



- 3D PRINTING SERVICES
- Custom 3D printing services
- FDM, polyjet, metal, stereolithography, SAF, P3/DLP, selective laser sintering
  - Online quoting tool
  - ITAR registered, ISO 9001:2015, AS90100 certified
  - 100+ material options

## Post Processing



- Automated cleaning & surfacing
- VaporFuse chemical smoothing
- Deep dye coloring
- End-to-end automated finishing



- Automated support removal
- Automated surface finishing
- Automated resin removal
- Proprietary post-printing chemistries



- SCA soluble support removal tanks
- SCA Waterjet: high-pressure support removal
- Custom automated finishing solutions



- Automated resin curing for solid waste
- Sustainable waste management solutions (EPA compliance)
- Post curing for DLP/P3

# Get In Touch With Us

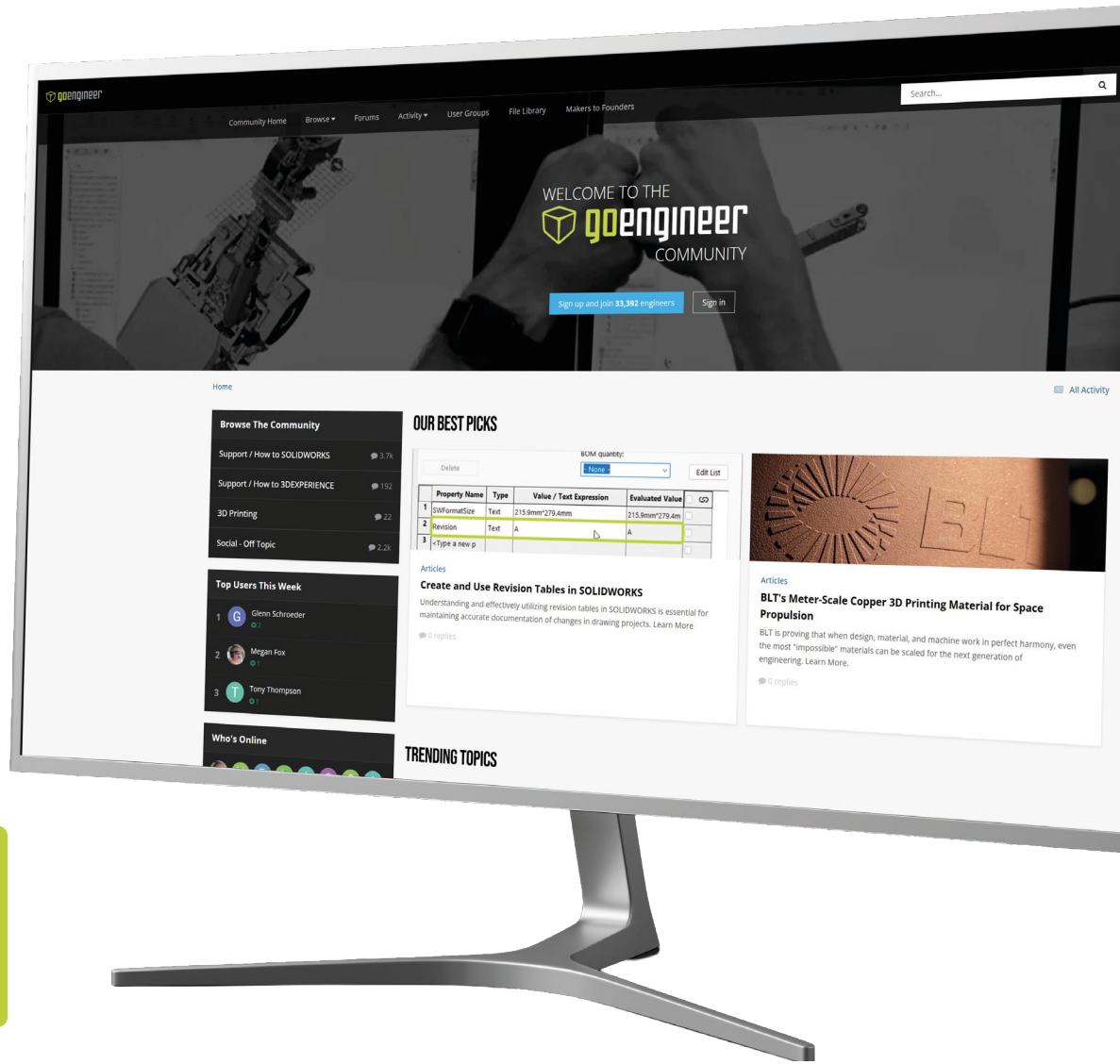

800.688.3234



goengineer.com  
info@goengineer.com



739 East Fort Union Blvd,  
Midvale, Utah, 84047