



stratasys[®]

Stratasys J750/J735/J720
3D Printing System



Copyright

DOC-08040 Revision U

Copyright © 2006–2022 Stratasys Ltd. All rights reserved.

This documentation contains proprietary information of Stratasys Ltd. This information is supplied solely to assist authorized users of Stratasys J750/J735/J720 3D printing systems. No part of this document may be used for other purposes.

The specifications on which this document is based are subject to change without notice.

Trademarks

Stratasys, PolyJet, J750, J735, J720, Digital Anatomy, GrabCAD Print, GrabCAD PolyJet Server, FullCure, Agilus30, Digital ABS, Vero, VeroBlack, VeroClear, VeroUltra, RGD810, RGD820, SUP707, SUP705, and SUP706 are trademarks of Stratasys Ltd. and/or its subsidiaries or affiliates and may be registered in certain jurisdictions. All other product names and trademarks are the property of their respective owners.

FCC Compliance

The equipment referred to in this guide has been tested and found to comply with the limits for a Class A device pursuant to part 15 of the FCC rules. These limits provide reasonable protection against harmful interference when the equipment is operated in a commercial environment. Stratasys 3D printing systems generate, use and can radiate radio-frequency energy and, if not installed and used in accordance with the instruction manual, may cause harmful interference to radio communications. Operation of this equipment in a residential area is likely to cause harmful interference, in which case the user will be required to correct the interference at his own expense.

The 3D printer referred to in this guide contains a transmitter module, FCC ID YH6-DUPCAB.

NOTE: Stratasys is not responsible for radio or TV interference caused by unauthorized modification to this equipment. Changes or modifications not expressly approved by the manufacturer could void the user's authority to operate the equipment.

Stratasys contact information is available from the [Stratasys Support Center](#).

Equipment Recycling



In the European Union, this symbol indicates that when the last user wishes to discard a product, it must be sent to appropriate facilities for recovery and recycling. For information about proper disposal, check your purchase contract, or contact the supplier of the equipment.

Limitation of Liability

The product, software or services are being provided on an “as is” and “as available” basis. Except as may be stated specifically in your contract, Stratasys Ltd. expressly disclaims all warranties of any kind, whether express or implied, including, but not limited to, any implied warranties of merchantability, fitness for a particular purpose and non-infringement.

You understand and agree that Stratasys Ltd. shall not be liable for any direct, indirect, incidental, special, consequential or exemplary damages, including but not limited to, damages for loss of profits, goodwill, use, data or other intangible losses (even if Stratasys has been advised of the possibility of such damages), resulting from: (i) the use or the inability to use the product or software; (ii) the cost of procurement of substitute goods and services resulting from any products, goods, data, software, information or services purchased; (iii) unauthorized access to or alteration of your products, software or data; (iv) statements or conduct of any third party; (v) any other matter relating to the product, software, or services.

The text and drawings herein are for illustration and reference only. The specifications on which they are based are subject to change. Stratasys Ltd. may, at any time and without notice, make changes to this document. Stratasys Ltd., for itself and on behalf of its subsidiaries, assumes no liability for technical or editorial errors or omissions made herein, and shall not be liable for incidental, consequential, indirect, or special damages, including, without limitation, loss of use, loss or alteration of data, delays, or lost profits or savings arising from the use of this document.

Patents

This product is covered by one or more of the following U.S. patents and other granted or pending patents.

7,209,797

7,364,686

7,369,915

7,500,846

7,604,768

7,658,976

7,725,209

7,896,639

7,958,841

7,991,498

7,996,101

8,219,234

8,278,866

8,323,017

8,469,692

8,781,615

8,865,047

8,932,511

9,017,589

9,020,627

9,031,680

9,227,365

9,662,834

10,632,679

10,828,905

10,894,399

10,940,616

10,994,475

Stratasys Ltd.

www.stratasys.com

DOC-08040

Revision U

December 2022



Contents

1 About This Guide

Using This Guide	1-2
Revision History	1-3
Terms Used in This Guide	1-5
Stratasys Online Resources	1-6
Stratasys Academy	1-6
Stratasys Support Center	1-7
Stratasys Academy YouTube Channel	1-7
GrabCAD Community	1-8

2 Safety

Safety Features	2-2
Symbols and Warning Labels	2-4
Safety Guidelines	2-5
Printer Installation	2-5
Printer Operation	2-5
UV Radiation	2-6
Printer Maintenance	2-6
Model and Support Materials	2-6
UV Lamps	2-7
First Aid for Working with Printing Materials	2-8
Contact with Skin	2-8
Contact with Eyes	2-8
Ingestion	2-8
Inhalation	2-9
Waste Disposal	2-9

3 Introducing the 3D Printer

Basic Features	3-2
Work Configurations	3-3
Source Files	3-4
Printing Materials	3-5
Storage	3-5
Shelf Life	3-5
Exposure to Light	3-5
Safety Considerations	3-6
Disposal	3-6
Work Environment	3-6

Workstation Requirements	3-6
4 Operating and Maintaining the Printer	
Starting the Printer	4-3
Loading Model and Support Cartridges	4-5
Producing 3D Prints	4-6
Preparing the Printer	4-6
Starting Printing	4-7
Printer Interface Color Key	4-8
Printing Indicators	4-9
Resuming Production After Printing has Stopped	4-10
Changing the Printing Material	4-13
Changing Model Materials Without Flushing	4-19
Printing With Bio-Materials	4-21
Advanced Settings	4-21
Keeping the Printer in Idle Mode	4-24
Setting the Cartridge Expiration Alert	4-25
Shutting Down the Printer	4-27
Maintaining the Printer	4-31
Routine Maintenance Schedule	4-31
Maintenance Counters	4-32
UV Lamp Check	4-34
Pattern Test	4-34
Backing up the Printer Configuration	4-37
Improving Print Quality	4-38
Cleaning the Print Heads, UV Lamp Glass, Roller and Wiper	4-38
Cleaning the Roller Waste Collector and Inspecting the Roller Scraper ...	4-43
Replacing the Roller Scraper	4-47
Aligning the Print Heads	4-49
Cleaning the Print-Head Splash Shield	4-54
Optimizing (Calibrating) Print Heads	4-56
Replacing Print Heads	4-63
Testing and Calibrating the UV Lamps	4-73
Calibrating the Load Cells	4-82
Flushing the Print-Block Heater	4-83
Replacing the Waste-Pump Tubes	4-89
Replacing the Material Filters	4-96
Replacing the Odor Filter	4-98
Replacing the UV Lamps	4-99
Improving Color Uniformity of X-Walls	4-108
Dynamic Nozzle Test	4-120

Built-in Tests	4-121
Replacing the Waste Container	4-127
Cleaning the Exterior Panels	4-129
Cleaning the UV Screen	4-129

5 Handling Printed Models

Removing 3D Prints After Printing	5-2
Removing the Support Material	5-2
Removing Support by Hand	5-3
Removing Support with Water Pressure	5-3
Removing SUP705/705B with Caustic Soda	5-4
Removing SUP706/706B with Caustic Soda and Sodium Metasilicate	5-4
Post-Printing Treatment	5-5
Photobleaching for Transparent 3D Prints	5-5
Storing 3D Prints	5-5

1

About This Guide

Using This Guide	1-2
Revision History	1-3
Terms Used in This Guide	1-5
Stratasys Online Resources	1-6
Stratasys Academy	1-6
Stratasys Support Center	1-7
Stratasys Academy YouTube Channel	1-7
GrabCAD Community	1-8

Using This Guide

This user guide provides instructions for installing, operating and maintaining Stratasys J750/J735/J720 3D printing systems, including Digital Anatomy printers. It explains how to use features, and provides practical examples to guide you as you use the system.

Important: Read the entire Safety chapter before using the system.

The text and figures in this guide are based on the J750 3D printer, software version D124_85.1; D124_86.1. They also apply to J735 and J720 printers.

This guide assumes that—

- all the hardware, software, and network components of your system are installed, configured, and operating correctly.
- the operator has a working knowledge of the Windows® PC platform.

Visit the [Stratasys Support Center](#) to download the latest revision of this document. This document is also available on the Support Center in other languages.

If you have any questions or comments about the way information is presented in this guide, or if you have any suggestions for future editions, please send a message to c-support@stratasys.com.

Revision History



Translations of this guide are updated periodically. If you are consuming a translated version, please check the English version for the latest revision and list of updates.

The following table lists the main changes in each revision of this document.

Revision	Release Date	Description
Rev. Q	February 2021	<ul style="list-style-type: none"> • <i>About this Guide</i> was updated. • <i>Additional Resources</i> was added. • <i>Workstation Requirements</i> was updated. • <i>Changing the Printing Material</i> was updated and a note was added to empty the waste container before starting the wizard. • <i>Replacing the UV Lamps</i> was updated with instructions for replacing the UV lamp bulb. • <i>Replacing the Odor filter</i> was updated. • <i>Improving the Color of X-walls</i> was added. • <i>Setting the Cartridge Expiration Date</i> was added. • <i>Cleaning the Print Head, Roller, and Wiper</i> was updated with cleaning the UV glass lenses instruction and with a note to empty the waste container before starting the wizard. • <i>Photobleaching for Transparent Parts</i> was updated. • <i>Aligning the Print Heads</i> was updated. • <i>Shutting Down the Printer</i> was updated with a note to empty the waste container before starting the wizard. • <i>Optimizing the Print Heads</i> was updated with a note to empty the waste container before starting the wizard. • Text, style and format improvements.
Rev. R	February 2021	<ul style="list-style-type: none"> • <i>Improving the Color of X-walls</i> was updated. • Text, style and format improvements.
Rev. S	May 2022	<i>Shutting Down the Printer</i> was updated with the number of cleaning-fluid cartridges needed when shutting down the printer for more than 30 days.

Revision	Release Date	Description
Rev. T	June 2022	<ul style="list-style-type: none"> • <i>Replacing the Waste-Pump Tubes</i> was updated to remove the clamp from the tube that is directed to the waste container. • <i>Using This Guide</i> was updated to provide information about how to get the latest revision of the document and how to send feedback. • <i>For More Information</i> was removed. • <i>Additional Resources</i> was renamed to <i>Stratasys Online Resources</i> and updated to include information about the Online Stratasys Academy including the Stratasys Academy YouTube Channel.
Rev. U	December 2022	<ul style="list-style-type: none"> • <i>Replacing the UV Lamps</i> was updated. • <i>Replacing the Material Filters</i> was updated. • <i>Replacing the Waste Container</i> was updated. • <i>Copyright</i> was updated to include information in the FCC Compliance section. • <i>Improving Color Uniformity of X-Walls</i> was updated. • Added support for software version D124_86.1. • <i>Patents</i> was updated to include the UKCA mark. • Other minor corrections.

Terms Used in This Guide

Build tray	<i>In the print preparation application:</i> The surface displayed on the screen that represents the actual build tray in the printer. <i>In the printer:</i> The substrate for 3D printing.
Cleaning fluid	Cleanser for flushing material feed tubes and the printing block, used to completely remove model and support material from the system before loading another type of material in the printer and before long-term shutdown. The cleaning fluid is supplied in material cartridges.
Client/user workstation	The workstation on which software is installed for preparing build trays for production on PolyJet printers. (There is no limit to the number of client workstations.)
GrabCAD Print	A software application for preparing print jobs on a variety of 3D printers, including J750/J735/J720 printers.
Mixed part	3D prints that are produced using more than one model material.
Mixed tray	A build tray containing 3D prints, each designed to be printed using a different model material.
Model material	Material used for building the 3D prints.
Printer computer	The computer inside the J750/J735/J720 printer that operates it.
Printer interface	The GUI (graphical user interface) used for controlling J750/J735/J720 printers.
Printer software, printer-control application	Software running on the computer in the J750/J735/J720 printer, controlling all printer operations.
Resin	The base substance from which photopolymer printing materials are made for use in Stratasys PolyJet printers.
STL	A file used for printing 3D models.
Support material	Material used for supporting the structure of models during production.

Stratasys Online Resources

Stratasys encourages you to learn more about additive technologies and your Stratasys printer. A wealth of information is available on our online platforms.

[Subscribe](#) to our customer newsletter for quarterly updates on Stratasys knowledge and training. You can learn about the release of new documentation and learning resources.

Stratasys Academy

[Stratasys Academy](#) is your online learning platform where you can quickly learn and acquire skills on additive technologies and your Stratasys printer.

To guide you in your learning, our online academy provides a variety of resources such as an extensive library of videos and eLearning modules. We periodically update the site with new content.

Start your learning journey today.

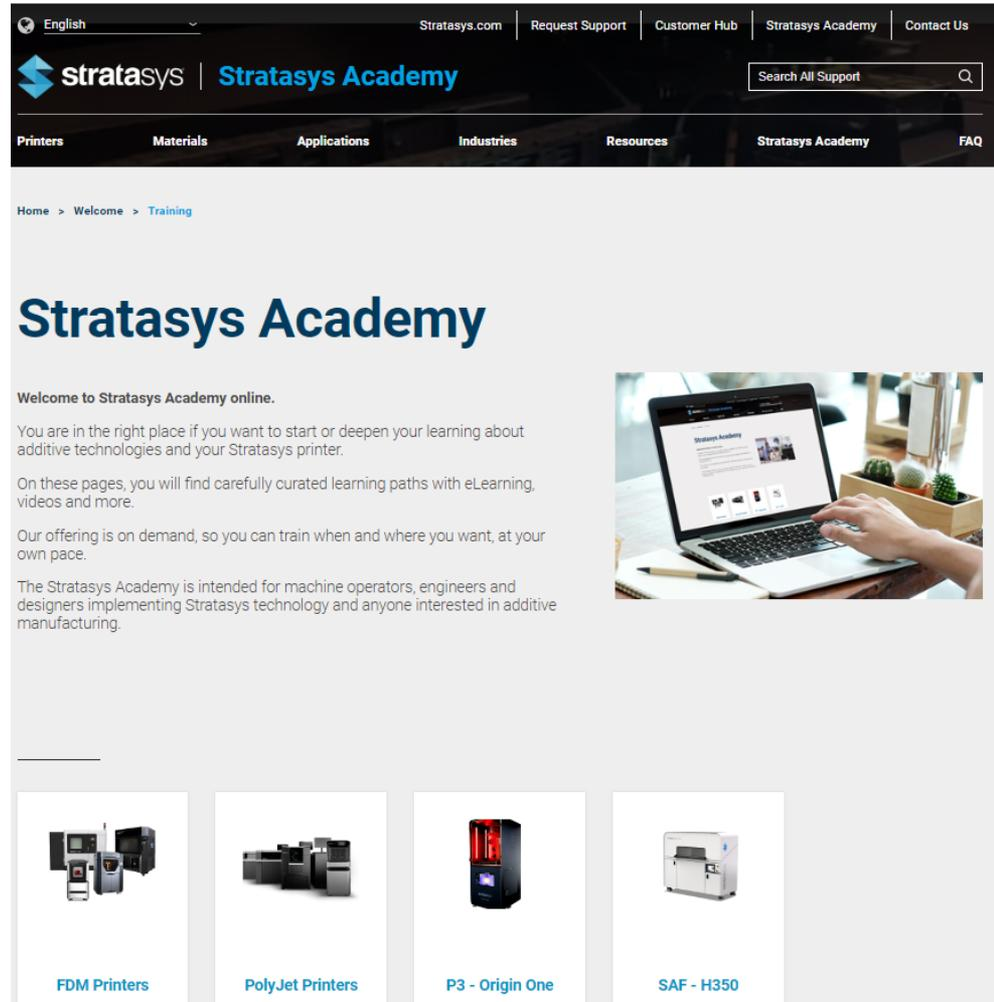

The screenshot shows the Stratasys Academy website. At the top, there is a navigation bar with links for "Stratasys.com", "Request Support", "Customer Hub", "Stratasys Academy", and "Contact Us". Below this is a search bar labeled "Search All Support". A secondary navigation bar includes "Printers", "Materials", "Applications", "Industries", "Resources", "Stratasys Academy", and "FAQ". The main content area features a breadcrumb trail: "Home > Welcome > Training". The title "Stratasys Academy" is prominently displayed. Below the title, a welcome message reads: "Welcome to Stratasys Academy online. You are in the right place if you want to start or deepen your learning about additive technologies and your Stratasys printer. On these pages, you will find carefully curated learning paths with eLearning, videos and more. Our offering is on demand, so you can train when and where you want, at your own pace. The Stratasys Academy is intended for machine operators, engineers and designers implementing Stratasys technology and anyone interested in additive manufacturing." To the right of the text is an image of a person's hands typing on a laptop displaying the Stratasys Academy website. Below the text and image is a horizontal row of four product categories, each with an image and a label: "FDM Printers", "PolyJet Printers", "P3 - Origin One", and "SAF - H350".

Stratasys Support Center

The [Support Center](#) is a knowledge base that includes information about design, applications, printing material, and links to many other resources.

In addition, you can check the latest revision of the user guide for your Stratasys 3D printer and download documents in different languages.

The Support Center is available in multiple languages. You can change the display language using the language drop-down menu in the top-left corner of the homepage.

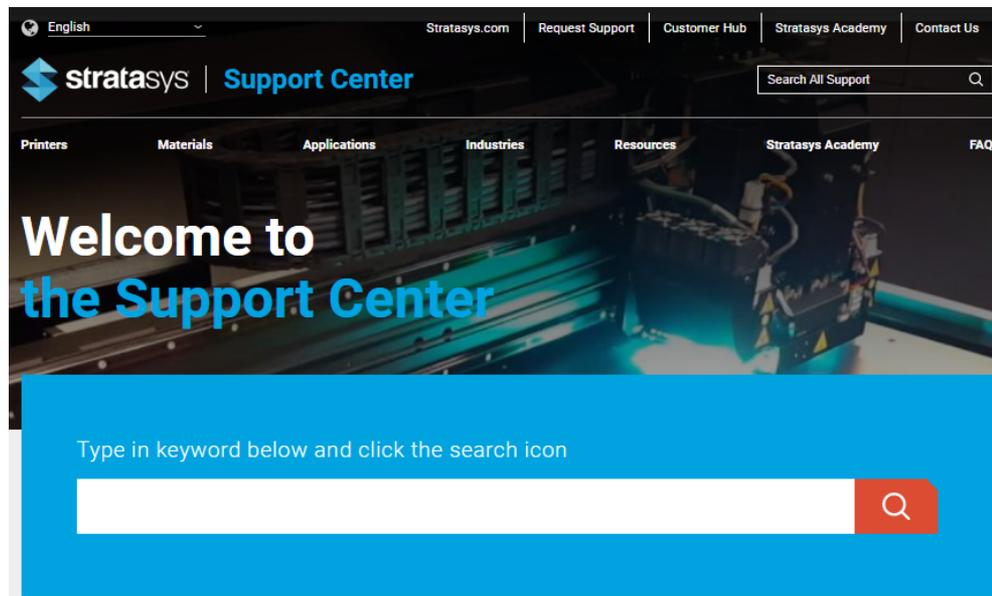

Stratasys Academy YouTube Channel

The [Stratasys Academy YouTube Channel](#) features instructional videos about how to operate and maintain Stratasys printers. The channel includes dedicated playlists for different printers and special topics like post-processing.

Make sure to check out this new Stratasys Academy Channel and remember to subscribe!

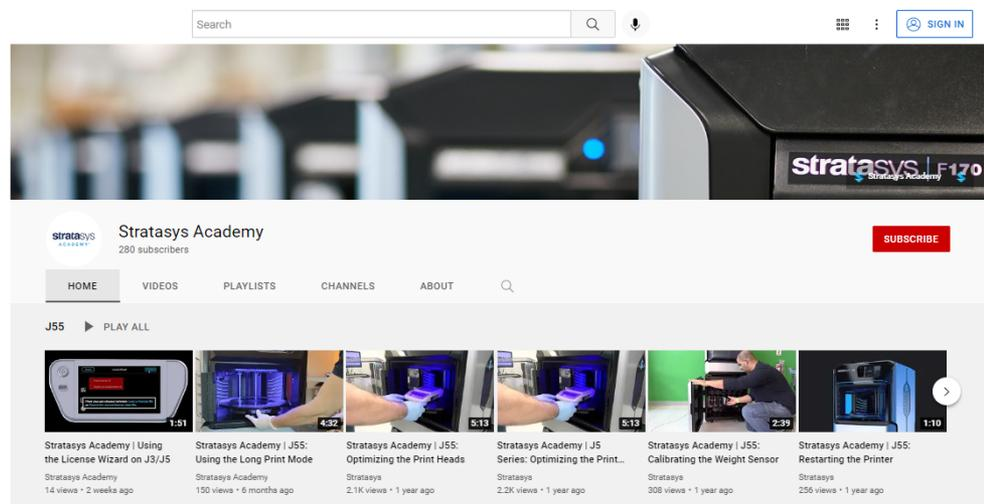

GrabCAD Community

The [Tutorials section of the GrabCAD Community](#) portal is a valuable resource for Stratasys-sponsored and user-generated 3D printing tips. You can also ask 3D-related questions on the portal and download free CAD files.

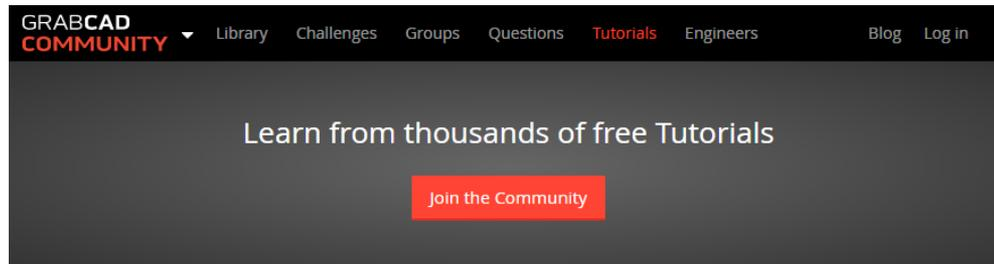

2

Safety

Safety Features	2-2
Symbols and Warning Labels	2-4
Safety Guidelines	2-5
Printer Installation	2-5
Printer Operation	2-5
UV Radiation	2-6
Printer Maintenance	2-6
Model and Support Materials	2-6
UV Lamps	2-7
First Aid for Working with Printing Materials	2-8
Contact with Skin	2-8
Contact with Eyes	2-8
Ingestion	2-8
Inhalation	2-9
Waste Disposal	2-9

Safety Features

Stratasys 3D printers are designed to comply with CE and FCC standards. They are equipped with the following safety features:

Interlock Switch

The power supplied to the UV lamp, the tray heater and the motion motors is turned off when the cover is opened.



Warning

Do not defeat (override) the interlock switch. Doing so could result in serious personal injury. If the interlock switch does not function correctly, do not use the printer, and contact your service provider.

Safety Lock

The cover is locked while the printer is working. If you do manage to lift it, the UV lamps and the motion motors turn off.



Warning

Do not defeat (override) the safety lock. Doing so could result in serious personal injury. If the safety lock does not function correctly, do not use the printer, and contact your service provider.

UV Screening

The transparent section of the cover blocks harmful UV radiation, allowing the operator to view the 3D prints during the printing process.



Figure 2-1 Front view of the printer

Circuit Breaker

The power to the printer is turned off in case of electrical overcurrent.

Note: The circuit breaker is only accessible to service personnel.

UV-Lamp Overheating Protection

The power supplied to the UV lamp and the motion motors is turned off if the temperature around the lamp reaches 90°C (194°F). A label on the UV-lamp cover indicates if the temperature has exceeded 65°C (150°F).

Grounded Chassis

The chassis of the printer is grounded, to prevent electrical shock.

Note: The power outlet must be grounded in accordance with the local electric code to provide this protection.



If the printer is not used as specified in this guide, these safety features may not provide adequate protection.

Symbols and Warning Labels

The following table lists the warning labels located on or in the printer.

Warning Symbol	Meaning	Location	Comments
	Hazard (general)	On the name plate on the back of the printer.	Read the instructions in this document before operating the printer.
	Hot surface	On the print block.	Risk of burns. Do not touch this surface after printing.
	High voltage	Near the UV lamp connectors. Near the power-supply enclosures.	Risk of electric shock. Disconnect the power before servicing.
	Ultraviolet radiation	Near the UV lamps.	Risk of injury to skin and eyes from ultraviolet radiation. Disconnect the power before servicing.

Safety Guidelines

The following general guidelines, together with the instructions provided throughout this user guide, ensure user safety while operating and maintaining the system. **If the system is not operated as specified, the user's safety may be compromised.**

Printer Installation

- Installation and removal of the printer should only be done by qualified service personnel.
- Connect the printer (and the UPS unit) to the electric outlet using a power cable that is safety-certified.
- The electric outlet should be easily accessible, near the printer.
- Never connect the power plug to an outlet that does not have a ground (earth) wire, and never disconnect the ground. Doing so might expose the operator to serious danger from electric shock.
- The following safety statement is followed by translations to Finish, Norwegian, Swedish and Danish, as required by local regulations:
“The machine must be connected to a grounded power outlet.”
 - FI: Laite on liitettävä suojakoskettimilla varustettuun pistorasiaan.
 - NO: Apparatet må tilkoples jordet stikkontakt.
 - SE: Apparaten skall anslutas till jordat uttag.
 - DK: Apparatets stikprop skal tilsluttes en stikkontakt med jord, som giver forbindelse til stikproppens jord.
- Leave a minimum of 15 centimeters (6 inches) between ventilation openings and walls or other objects.
- **For Japan:** The power cable supplied is provided for connecting the printer to the AC electric source. Do not use it with other equipment.

Printer Operation

- The printer should only be operated by persons trained by an authorized Stratasys representative.
- All persons operating or maintaining the printer should know the location of first aid and emergency equipment and how to use it. **Never block access to this equipment.**
- Keep fingers and other body parts clear of the printer when closing the cover.
- Never attempt to open the printer while it is working.
- Never override the interlock safety switch.
- If the interlock safety switch ever fails, **do not use the printer.**
- Several parts of the printer remain extremely hot even after it has stopped operating. Avoid touching the UV lamps and the print block.

UV Radiation

The UV lamps used in the printer emit dangerous radiation

- If the UV lamps remain on when the printer is open, do not stare directly at the UV light. Shut down the printer and call your Stratasys service provider.

Printer Maintenance

- Service operations should be performed only by qualified personnel who have been instructed in relevant safety precautions.
- Notify co-workers and those who have access to the printer before beginning non-routine and hazardous work.



Report any potential dangers and safety-related accidents to your safety officer or to other appropriate authorities.

Model and Support Materials

Model and support materials are made of chemical substances. Although precautions must be taken when handling these materials directly, all model and support materials used by the printer are handled in sealed cartridges. Normally, operators of the printer should never be directly exposed to hazardous materials. In the unlikely event of a leak or spill, follow the instructions that are included with the material cartridges used.

- Store model and support materials indoors, in a dry area with adequate ventilation, between 15-25 degrees Celsius (59-77 degrees Fahrenheit). Never expose them to flames, heat, sparks, or direct sunlight.
- Keep model and support materials away from areas where food and drink are stored, prepared and consumed.
- Uncured printing material is considered a hazardous substance, requiring certain precautions when directly handling it. To prevent skin irritation, wear **neoprene** or **nitrile gloves**. If there is any chance that model and support materials might splash into the eyes, wear safety goggles. Prolonged direct contact with printing materials can cause an allergic reaction.
- When handling UV-cured 3D prints that may not be completely cured on the surface, common latex gloves are adequate.
- To prevent respiratory irritation, ventilate areas where model and support materials are used. If the printer is not equipped with an exhaust duct, the room ventilation system should replace the air 4–6 times per hour.
- Clean up model-material and support-material spills with disposable towels or other absorbent, non-reusable material, such as sawdust or activated charcoal. Rinse the spill area with denatured or isopropyl alcohol (IPA), followed by soap and water. Dispose of the absorbent material in accordance with local regulations.
- Do not wash contaminated clothing at home; clothing should be professionally laundered.

- Dispose of contaminated shoes, belts and other leather items in accordance with any applicable regulations. Absorbed printing material may re-expose the user when these items are worn.

UV Lamps

UV lamps used by the printer to cure printing materials contain a small amount of mercury. In the unlikely event of lamp breakage, avoid inhaling mercury vapor, and ventilate the room. If the lamp ruptures (breaks) during operation, leave the room and ventilate it thoroughly for about 30 minutes.

Use protective gloves to prevent contact with mercury and other lamp components. Carefully remove spilled mercury with a method that prevents the generation of mercury vapor, such as a syringe, packing tape or paper.

Place the broken lamp, mercury and contaminated materials in an air-tight, non-metallic container. Dispose of the container in accordance with applicable regulations.

First Aid for Working with Printing Materials

In general, try to avoid direct contact with uncured printing material. If skin or eyes come into contact with it, wash the area immediately and thoroughly with water, and follow these first-aid instructions.



The Material Safety Data Sheet (MSDS) that accompanies printing materials contains important safety information. Keep this in an accessible place where these materials are used and stored.

Contact with Skin

If uncured printing material comes in contact with skin, wash the affected area immediately and thoroughly with soap and cool water, then remove contaminated clothing. Pay particular attention to flushing the hair, ears, nose and other parts of the body that are not easily cleaned.

- Use cool water to prevent skin pores from opening, so that the liquid material does not easily penetrate the skin.
- Do not use solvents to clean skin.
- If large areas of skin have been exposed, or if prolonged contact results in blisters, seek medical attention. In any case, if irritation persists, seek medical attention.
- Avoid the accidental transfer of printing material from the hands to other areas of the body, especially to the eyes.
- If protective cream was used, do not reapply it until the skin has been completely cleansed.

Contact with Eyes

If uncured printing material comes in contact with the eyes, flush immediately with large amounts of water for 15 minutes and seek medical attention.

- Avoid sunlight, fluorescent light, and other sources of ultraviolet radiation. Wearing contact lenses when handling liquid printing materials is not recommended. If the liquid splashes into the eyes when contact lenses are worn, immediately remove the lenses and flush the eyes with water.
- Clean and disinfect the contaminated lenses.
- Do not wear contact lenses until eye irritation disappears.

Ingestion

If printing material is swallowed, refer to the instructions included with the cartridge. **Seek medical attention immediately.**

Inhalation

Vapors from printing materials can be irritating to the respiratory system. If respiratory irritation occurs, expose the victim to fresh air immediately.

- If the victim has stopped breathing, perform artificial respiration or cardiopulmonary resuscitation.
- Seek medical attention immediately.
- Keep the victim warm but not hot.
- Never feed anything to an unconscious person.
- Oxygen should be administered by authorized personnel only.

Waste Disposal

Fully cured 3D prints can be disposed of as ordinary office trash. However, special care is required when handling printer waste (uncured printing material).

Printing Materials

- When removing the waste cartridge/container from the printer, wear neoprene or nitrile gloves.
- To prevent liquid waste from splashing into the eyes, wear safety goggles.
- Liquid waste from the printer is classified as hazardous industrial waste. Therefore, printing-material waste must be packaged and disposed of in a manner that prevents human contact with it and contamination of water sources.
- Empty model-material and support-material cartridges contain residue of their contents. Some leakage of this residue may occur through the broken cartridge seal. Therefore, handle and store empty cartridges with care.
- Do not attempt to reuse empty cartridges, and do not puncture them.
- Dispose of used cartridges and waste containers in accordance with local regulations.
- Discard contaminated clothing, shoes, empty containers, etc., in accordance with any applicable regulations.

UV Lamps

UV lamps used by the printer to cure printing materials contain a small amount of mercury, and are considered “Universal Waste.” Recycle or discard used lamps in accordance with applicable regulations.

Broken lamps:

After ventilating the area, use protective gloves and carefully remove spilled mercury with a method that prevents the generation of mercury vapor, such as a syringe, packing tape or paper. Place the broken lamp, mercury and contaminated materials in an air-tight, non-metallic container. Dispose of the container in accordance with applicable regulations.

3

Introducing the 3D Printer

Basic Features	3-2
Work Configurations	3-3
Source Files	3-4
Printing Materials	3-5
Storage	3-5
Shelf Life	3-5
Exposure to Light	3-5
Safety Considerations	3-6
Disposal	3-6
Work Environment	3-6
Workstation Requirements	3-6

Basic Features

Stratasys J750/J735/J720 printers offer the following options:

- You can streamline and economize the process of producing 3D prints.
 - Producing 3D prints made from different materials on the same build tray (“mixed tray”), in the same print job, eliminates the time-consuming need and expense of loading another material, flushing the system, and sending a separate job to be printed.
 - Alternating print jobs that use any of the model materials (or material combinations) loaded similarly does not require material replacement—again, saving time and expense.
- You can print objects with combinations of basic materials (*digital materials*), enabling you to choose from a wide range of possible mechanical properties—from flexible to rigid.
- You can print parts (shells) of the same part—simultaneously—with different materials (or material combinations)
- You can produce 3D prints that have a “coating” made from a different material than the main part of the 3D print.
- You can mix any combination of base materials, resulting in an extremely wide range of available colors.
- If you designate colors for parts of a 3D print at the design stage (with CAD software) and save it as a VRML file, the parts are automatically assigned appropriate material combinations in GrabCAD Print for production with the desired colors.
- You can choose the preferred support material for your needs.

GrabCAD Print supports many 3D CAD file formats, eliminating the need to convert them to STL files. GrabCAD Print can also repair damaged files before sending them to the printer.

Work Configurations

Stratasys J750/J735/J720 3D printing systems can be set up as single-station systems or as multi-station systems. When connected to a local computer network, the system can serve multiple users. In such configurations, each user (client) prepares files for production. A software service, installed on the printer computer, processes jobs and controls the printing.

Figure 3-1 shows the printer set up in a multi-client configuration.

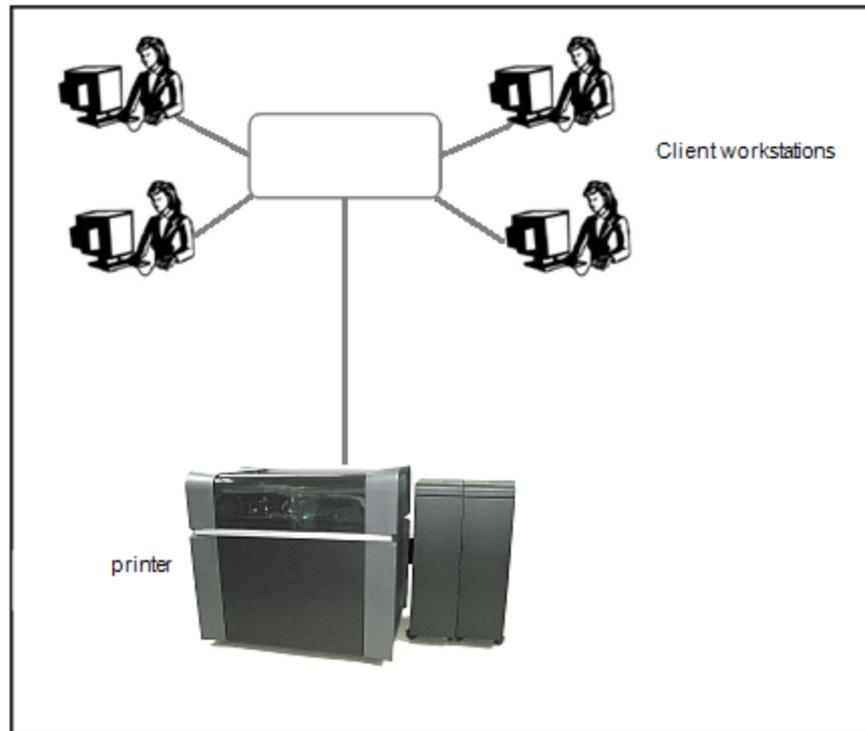

Figure 3-1 Multi-client network configuration

Source Files

Stratasys J750/J735/J720 printing systems produce 3D prints designed with most CAD tools and some other 3D applications.

GrabCAD Print supports STL, VRML, OBJ and 3MF files. In addition, GrabCAD Print supports native CAD formats from these programs: Creo, SOLIDWORKS, NX, CATIA and Inventor. To see the complete list of file formats supported by GrabCAD Print, go to: help.grabcad.com/print/file-formats.

J750/J735/J720 systems feature the capability of producing different types of files simultaneously.

Printing Materials

Stratasys J750/J735/J720 printers produce 3D prints by jetting thin layers of printing materials on the build tray, until the complete 3D print is formed. Two types of material are used in this process:

- *Model* material—which makes up the finished 3D print.
- *Support* material—which fills gaps and spaces in the part during printing, and is removed after printing.



For up-to-date information about PolyJet printing materials and their properties, go to www.stratasys.com/materials/polyjet.

Storage

Materials used for producing 3D prints with J750/J735/J720 printers are made of resins, which are composed of reactive monomers and oligomers. Although printing materials are supplied in sealed, UV-proof cartridges, care must be taken when storing and handling them. Follow these guidelines to protect operators and the environment, and to ensure optimum results.

- To ensure product stability, do not allow these materials to come into contact with metal. Plastics made from monomer-soluble substances (such as polystyrene or polyvinyl chloride) are not suitable for storing PolyJet printing materials.
- When not in use, keep material cartridges tightly sealed to prevent contamination, the effects of exposure to UV radiation, and accidental spillage.
- Store material cartridges indoors, in a dry area with adequate ventilation, between 15–27 degrees Celsius (59-81 degrees Fahrenheit). If exposed to heat or flames, cartridges might burst or ignite.
- Signs of premature polymerization in material cartridges include bulging, leaking, the emission of heat, and unusual odor. Exposure to heat can cause resin to gel in the cartridges.
- Make sure that material cartridges are stored in accordance with all local regulations and other applicable requirements.

Shelf Life

Materials used for producing 3D prints have a limited shelf life. The expiry date on the label is valid when properly stored in an undamaged, unopened cartridge. Always rotate your stock, so that the cartridge with the earliest date is used first.

Exposure to Light

If printing materials are not in their sealed cartridges, make sure to shield them from sunlight and other sources of UV radiation, such as fluorescent and

mercury-vapor lights. Exposure to UV radiation causes an increase in viscosity and, eventually, solidification.

Safety Considerations

Before being cured, resins are hazardous materials. To prevent possible health hazards, follow these precautions regarding printing materials:

- Do not expose to flames, heat or sparks.
- Prevent contact with skin and eyes.
- Ventilate areas where they are handled.
- Keep them separate from food and drink.

Cured plastic parts, however, are safe. They can be handled and stored without precautions.



You can find more safety information about resins in:

- "Safety Guidelines" on page 2-5
- "First Aid for Working with Printing Materials" on page 2-8

Disposal

Dispose of cartridges of model and support material in accordance with all applicable laws and regulations.

Work Environment

Extreme heat and humidity conditions can adversely affect the operation of your J750/J735/J720 3D printer. Use ventilation or air-conditioning systems, if necessary, to keep the work area within the following ranges:

- 18°–25° C (64°–77° F)
- 30%–70% relative humidity

Workstation Requirements

GrabCAD Print is an application for preparing and managing print jobs on Stratasys J750/J735/J720 printers (and on other supported 3D printers).

- To download GrabCAD Print, go to: help.grabcad.com/print/sign-up.
- If there are several users in your company, you need to set up a company. To do this: help.grabcad.com/article/203-all-about-company-accounts
- To see the requirements for client computers running GrabCAD Print, go to: help.grabcad.com/print/system-requirements.
- In addition to GrabCAD Print on client computers, GrabCAD PolyJet Job Manager is required on the printer computer. This is the program that controls the actual printing. To download it, go to: help.grabcad.com/print/polyjet.

4

Operating and Maintaining the Printer

Starting the Printer	4-3
Loading Model and Support Cartridges	4-5
Producing 3D Prints	4-6
Preparing the Printer	4-6
Starting Printing	4-7
Printer Interface Color Key	4-8
Printing Indicators	4-9
Resuming Production After Printing has Stopped	4-10
Changing the Printing Material	4-13
Changing Model Materials Without Flushing	4-19
Printing With Bio-Materials	4-21
Advanced Settings	4-21
Keeping the Printer in Idle Mode	4-24
Setting the Cartridge Expiration Alert	4-25
Shutting Down the Printer	4-27
Maintaining the Printer	4-31
Routine Maintenance Schedule	4-31
Maintenance Counters	4-32
UV Lamp Check	4-34
Pattern Test	4-34
Backing up the Printer Configuration	4-37
Improving Print Quality	4-38
Cleaning the Print Heads, UV Lamp Glass, Roller and Wiper	4-38
Cleaning the Roller Waste Collector and Inspecting the Roller Scraper	4-43
Replacing the Roller Scraper	4-47
Aligning the Print Heads	4-49

Cleaning the Print-Head Splash Shield	4-54
Optimizing (Calibrating) Print Heads	4-56
Replacing Print Heads	4-63
Testing and Calibrating the UV Lamps	4-73
Calibrating the Load Cells	4-82
Flushing the Print-Block Heater	4-83
Replacing the Waste-Pump Tubes	4-89
Replacing the Material Filters	4-96
Replacing the Odor Filter	4-98
Replacing the UV Lamps	4-99
Improving Color Uniformity of X-Walls	4-108
Dynamic Nozzle Test	4-120
Built-in Tests	4-121
Replacing the Waste Container	4-127
Cleaning the Exterior Panels	4-129
Cleaning the UV Screen	4-129



Figure 4-1 The Stratasys J750/J735/J720 3D Printer

Starting the Printer



Caution

- Do not attempt to operate the printer before being trained by an authorized Stratasys representative.
- Observe all safety warnings and follow the safety guidelines described in Chapter 2.

1. Turn on the main power switch, located at the back of the printer.



Figure 4-2 Main power switch and cable

The main power switch turns on the J750/J735/J720 printer, which includes the built-in computer.

2. After the printer-control computer boots, log in to Windows and launch the printer-control program:
 - On the printer-computer desktop, double-click the J750/J735/J720 printer icon.
 - or—
 - From the Windows *Start* menu, select **(All) Programs > Objet > J750/J735/J720**.



A HASP plug containing a valid product activation key is required on the printer computer. This is supplied during printer installation or upgrade. If the application does not open and a HASP message appears, contact your Stratasys dealer or service provider.

All monitoring and controlling of the printer is done from this interface.

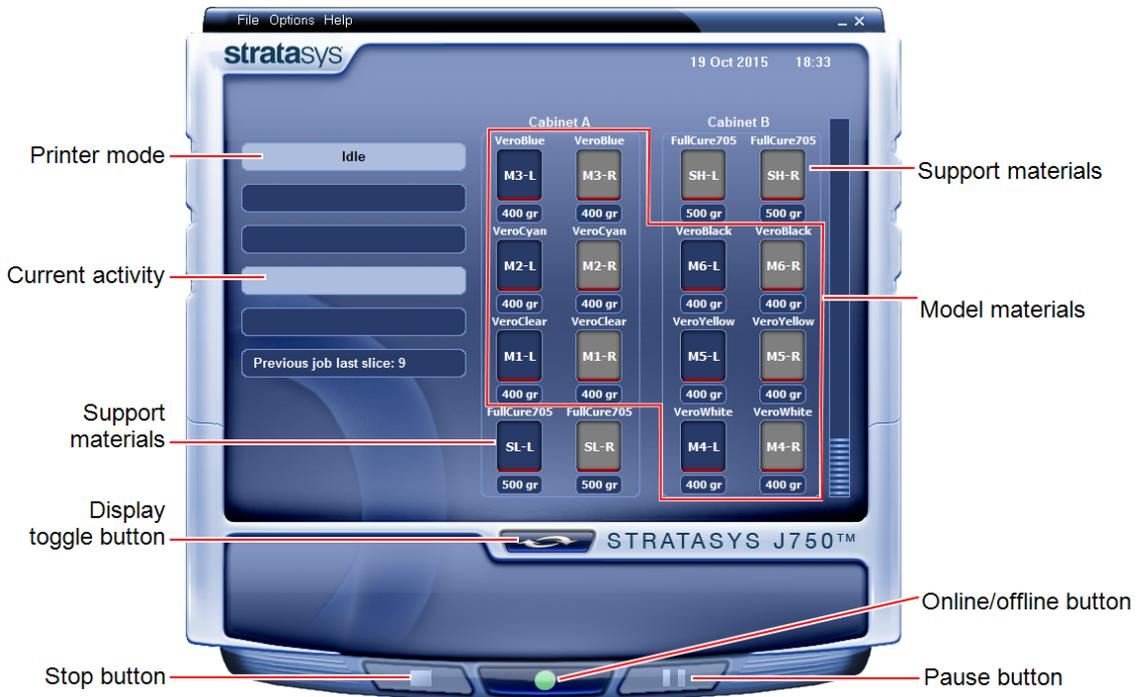

Figure 4-3 Printer interface

Loading Model and Support Cartridges

Stratasys J750/J735/J720 printers use up to 12 cartridges of model material and up to four cartridges of support material, each weighing 3.6 kilograms when full.

A graphical representation of the cartridges loaded and their current weight appears in the [printer interface](#) (see the figure on the previous page).



The material cabinet contains a module that identifies loaded printing materials. Tampering with this module will render the printer inoperable and may void Stratasys warranties and service contracts.

Important: If you need to replace the printing material currently installed with another type, see "Changing the Printing Material" on page 4-13. Otherwise, make sure to replace the material cartridge with one containing the same type of material.

To load model and support material:

1. Open the material cabinet.
2. Load model and support cartridges into their respective compartments.
You should feel some resistance, as a needle pierces the cartridge seal.
3. Check the printer interface to make sure that the new cartridge is detected and that its weight is displayed (see the figure on the previous page).
4. Close the material cabinet.

Tips about loading and replacing material cartridges:

- You can replace material cartridges either before or during printing.
- You can load partially used cartridges, provided that they contain more than 100 grams of material.
- You can replace a partially used cartridge to avoid the need for replacing it during printing.
- The cartridge type is automatically detected by the printer. If you replace a cartridge containing different model material, a message appears recommending that you run the Material Replacement wizard to flush out the old material.
- If printing stops for an extended time before you replace a material cartridge, the printer may go into *Standby* or *Idle* mode. If this happens, see "Resuming Production After Printing has Stopped" on page 4-10.

Producing 3D Prints

3D prints can be produced after they are arranged on the virtual build tray in the GrabCAD Print application. For information about preparing files for printing, see the GrabCAD Print [online documentation](#).

Preparing the Printer

Before beginning to produce 3D prints, it is recommended that you check the current printing quality of the print heads by performing the Pattern Test.

To prepare the printer for printing:

1. Make sure that the build tray in the printer is empty and clean.
2. If not, remove cured material with the scraper, and clean the tray thoroughly with a cleaning cloth soaked with 90% alcohol (IPA or ethanol).



Caution

Use protective gloves when cleaning the build tray, and be careful of the sharp edges of the scraper blade.

3. Make sure that there is sufficient model and support material loaded, as indicated on the printer interface (see the figure on page 4-4). You may want to replace the cartridges of model and support material currently loaded in the printer to avoid the need for replacing them during printing.

Note: When you click *Print* in GrabCAD Print, a warning message appears if there is not enough of one or more material.

For loading material cartridges and replacing empty ones, see "Loading Model and Support Cartridges" on the previous page.

For changing the *type* of material currently loaded, see "Changing the Printing Material" on page 4-13.

You can monitor printer status by switching the printer interface display. To do this, click the display toggle button on the printer interface screen.

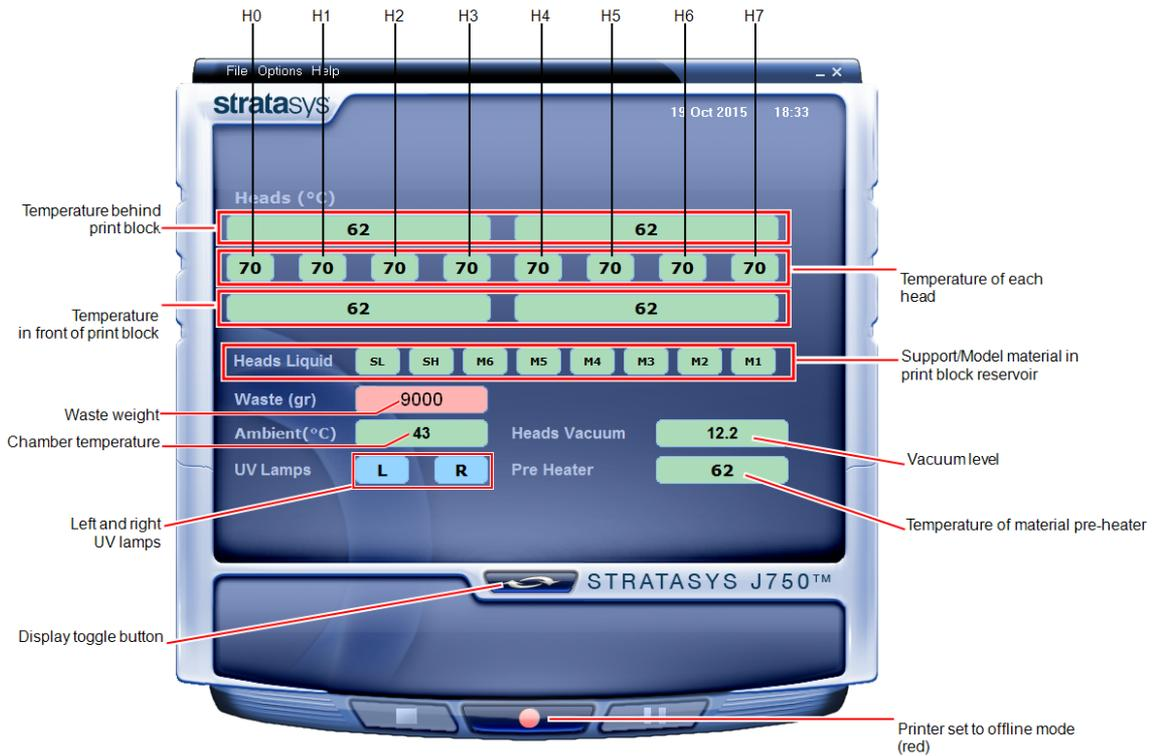

Figure 4-4 Printer status

Starting Printing

To begin printing:

- On the printer interface, click the red button to switch the printer to *online* mode.

The color of the button changes from red to green (see the figure on page 4-4). If there is a job in the printing queue, it is sent to the printer.

When switching the printer to *online* mode, a message is displayed if a maintenance activity is required to ensure optimum printing quality. (See "Routine Maintenance Schedule" on page 4-31.) Maintenance notifications can be disabled/enabled from the *Options* menu.

In the printer interface, the printer mode changes from *Idle* to *Pre-print*, as the printer's components prepare themselves for production:

- The print block is heated.
- The UV lamps are powered and they warm up.

When printing begins, the print manager program sends a number of slices to the printer-control application. This fills the buffer between the print manager and the printer to ensure continuous printing. As each slice is printed as a layer on the build tray, another slice is sent to the printer.

Depending on the size of the 3D print(s) to be produced, printing can take between several hours to several days. As long as there is enough model and support material in the supply cartridges, printing proceeds automatically until the job is finished.

J750/J735/J720 printers use up to six different model-material cartridges to produce 3D prints. In addition, two support-material cartridge are required. If additional cartridges are installed and they are not immediately needed for printing, the printer interface indicates this (see "Printer Interface Color Key" below).

Printer Interface Color Key

The background colors in the printer indicator fields tell you at a glance whether or not the value or item is suitable or ready for printing.

- **Green**—suitable/ready for printing

For example, in Figure 4-4 on the previous page:

- Heads (°C)*—The heads have reached the temperature required for printing.
- Ambient*—The ambient temperature of the printing chamber is within the acceptable range.
- Heads Liquid*—The level of model and support material in the print-block reservoir is OK.
- Heads Vacuum*—The vacuum level in the system is within the acceptable range.
- Pre-Heater*—The model and support resins have been heated to the required temperature before being supplied to the print block.

- **Blue**—not ready

For example, in Figure 4-4 on the previous page:

- UV lamps*—The UV lamps are not on.

- **Red**—not suitable for printing (or indicates a warning)

For example, in Figure 4-4 on the previous page:

- Waste*—The weight of the waste container is 9000 grams, more than allowed when beginning a print job. (See "Replacing the Waste Container" on page 4-127.)

The color of the material cartridges displayed in the printer interface indicates which cartridges are active for the current (or next) print job.

For example, in Figure 4-3 on page 4-4:

- *Blue*—active cartridge
- *Gray*—reserve cartridge

Printing Indicators

The printer interface screen changes when you send a print job to the printer, if the printer is *online*:

- The mode changes from *Pre-print* to *Printing*.
- The specific activity being performed is shown in the “current activity” field.
- Current job-printing information is displayed.
- The printing progress bar is displayed.
- The *Stop* and *Pause* buttons are enabled.

When the weight of a cartridge drops below 100 grams, the display of the material level in the printer interface is *red*.



Figure 4-5 Printer interface during printing

Resuming Production After Printing has Stopped

If the printing process is interrupted, the print manager stops sending slices to the printer. This can happen, for example, if the printing material runs out in the middle of a print job, and you do not replace the empty cartridge immediately. After the printer changes to *Standby* or *Idle* mode, you need to resume printing from the print manager in GrabCAD Print.



After printing stops, the printer goes into *Standby mode*, when heating of the print heads is reduced. About 10 hours later, the printer goes into *Idle* mode, when heating of the print heads is stopped.

To continue printing :

1. If the printer is in *offline* mode, switch it to *online* mode by clicking the red button at the bottom of the printer interface (see the figure on page 4-4). The button changes from red to green.
2. If you don't know why printing has stopped, make sure that the connection between the printer and the server computer is active.
3. Open the *Schedule* screen of GrabCAD Print.

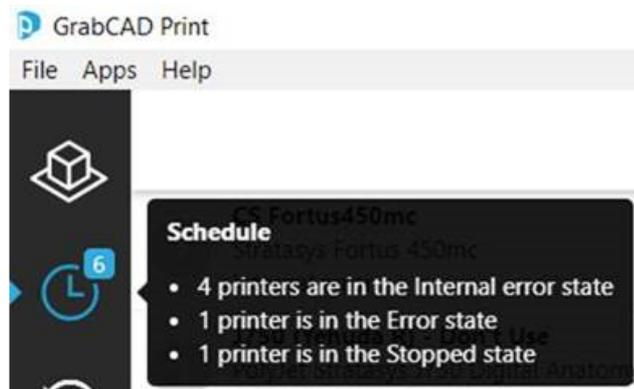

Figure 4-6 Opening the *Schedule* screen

4. Locate the stopped job.



Figure 4-7 Stopped job in the *Schedule* screen

5. Click on the job to display the Job Status details, and click the *Resume* icon



OR—

Right-click on the job to display the pop-up menu, and select **Resume job**.



- In GrabCAD Print, make sure that the correct slice number is entered in the dialog box.



Figure 4-8 Slice confirmation in GrabCAD Print

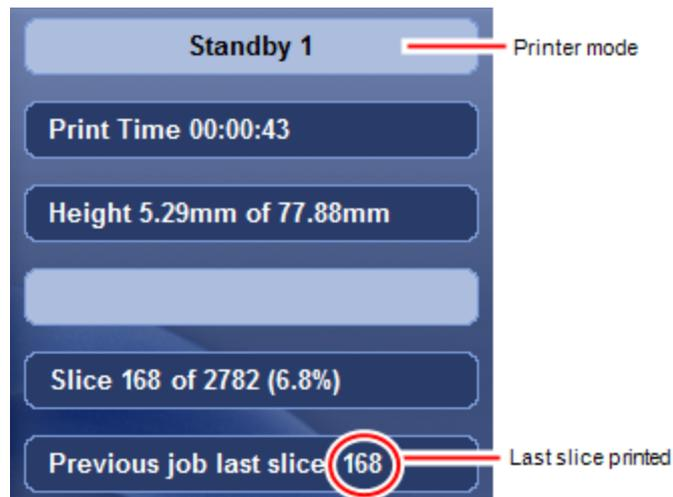

Figure 4-9 Printer interface after interrupted printing

- If, for any reason, the correct number does not appear in the dialog box, enter the number and click **OK**.

You cannot continue printing if:

- The number of the last slice printed does not appear in the printer interface, even if the server computer displays the confirmation dialog box.
- There was a relatively long interruption in printing, even if the “last slice” and indicators are correct. This is because the part already printed might slightly deform or shrink before printing continues, causing a visible difference between it and the part printed later. The effects of a printing stoppage

depend on part size and structure, the model material used, ambient temperature and the length of the stoppage.

If you cannot continue printing:

1. Cancel the job.

In GrabCAD Print, in the *Schedule* screen (see above):

- Right-click on the job to display the pop-up menu, and select **Cancel job**.



OR—

- Left-click on the job to display the Job Status details, and click the

Cancel icon .

2. Remove the partially printed 3D print from the build tray.
3. Resend the job to the printer.

- Click .



You can stop printing from either the printer interface or from GrabCAD Print.

- After clicking the *Stop* button in GrabCAD Print, you can resume printing from GrabCAD Print or from the printer interface.
- After stopping printing from the printer interface, you can resume printing **only** from the printer interface.
- After clicking the *Pause* button in the printer interface, you can resume printing **only** from the printer interface.

Changing the Printing Material

Before producing 3D prints using a different type of printing material than is currently installed, run the Material Replacement wizard to flush the print block and feed tubes.



Before running the wizard, empty the waste container. A full waste container can cause the wizard to cancel or freeze.

After using the wizard to change the support material and certain model materials, Head Optimization is required before printing.



You should carefully plan production of 3D prints the with different materials to avoid unnecessary waste of the materials currently loaded. The amount of material flushed depends on the flushing cycle chosen and if you are replacing one or more cartridges.

The Material Replacement wizard suggests the best slot locations for placing different material cartridges, based on the materials currently in the system. This ensures minimum flushing of materials currently loaded.

Note: When performing manual material replacement, certain replacement options are blocked to protect the system. In these cases, follow the recommendations of the Material Replacement wizard for best replacement options.

To replace the printing material with the wizard:

1. Start the Material Replacement wizard from the *Options* menu.

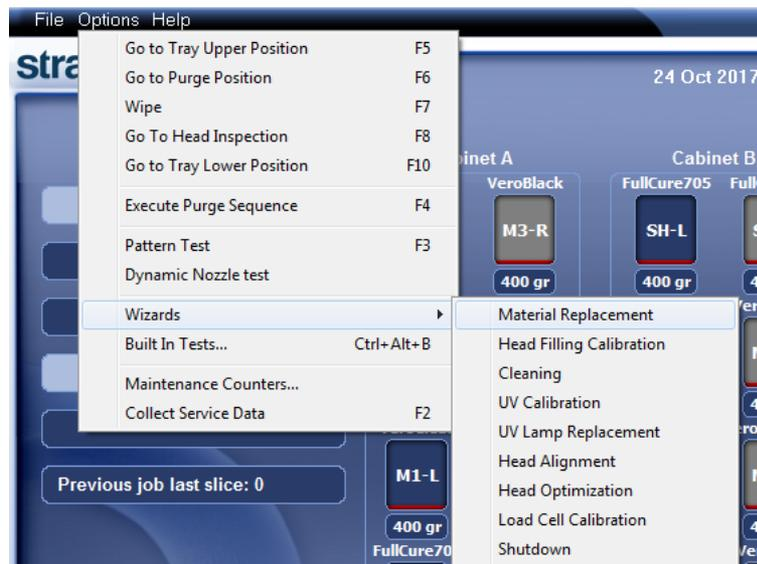

Figure 4-10 Starting the Material Replacement wizard

2. In the opening screen, click **Next**.
3. If the printer cover is not closed, a screen appears, prompting you to close the cover. Confirm that it is closed and click **Next**.



When SUP705/705B Support material is loaded, Digital Anatomy materials cannot be used.
To print Digital Anatomy models, use SUP706/706B Support material.

4. Choose the configuration for producing 3D prints:

- 6 materials
- 3 materials

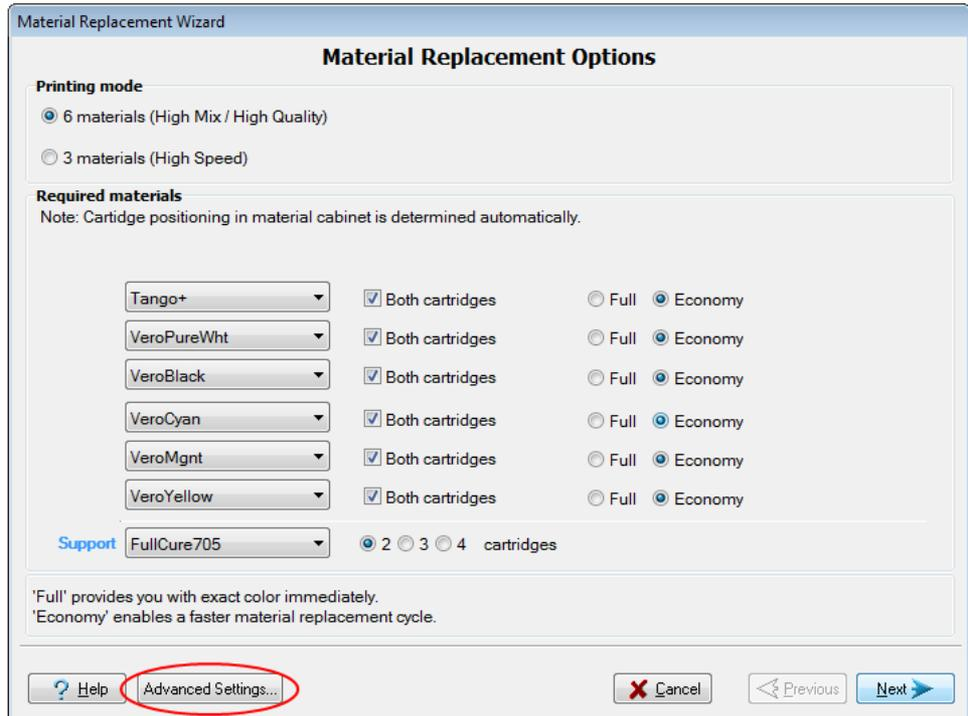

Figure 4-11 Material Replacement Options

6 Materials

Each of the three model print heads is loaded with two different materials.

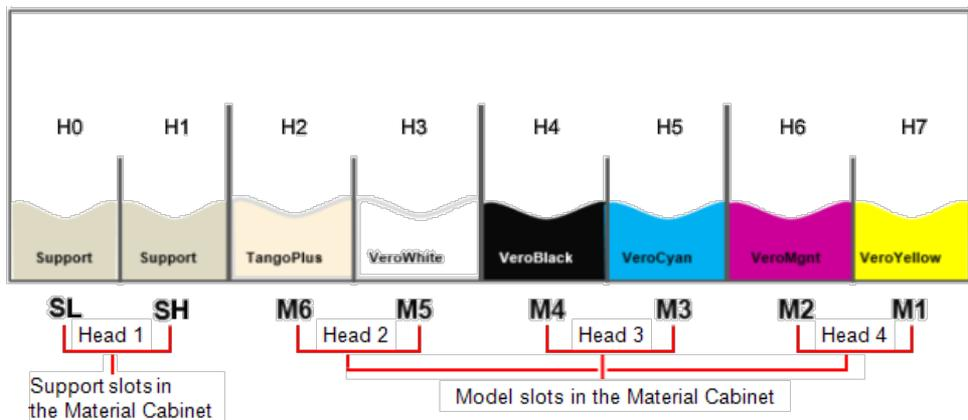

Figure 4-12 Six model materials loaded in the print heads

You can print with any single material, or with a combination of them. High-speed printing is not available, but high-quality 3D prints can be produced.

3 Materials

Both sections of each print head are loaded with the same material.

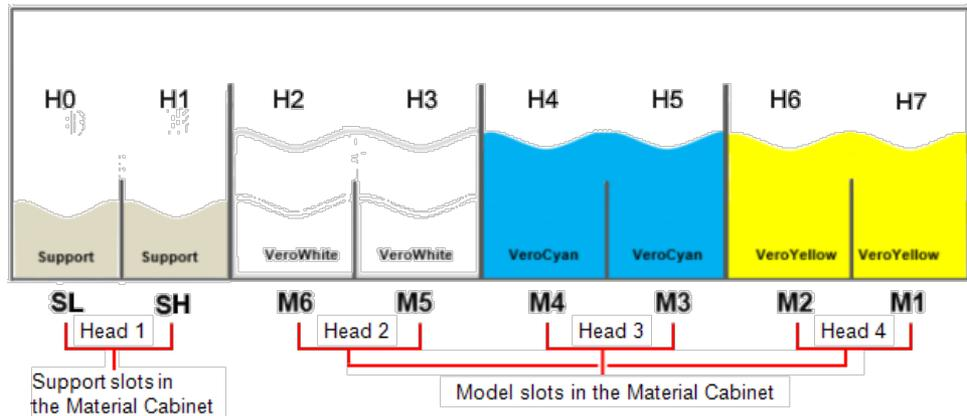

Figure 4-13 Three materials loaded in the print heads

Up to three model materials are available, with high-speed printing.

5. In the *Required materials* section of the wizard screen, select one or more replacement materials cartridges.
6. For model materials, select **Both** if you need to load two replacement cartridges.
Loading one replacement cartridge is more economical because it potentially requires less flushing of material currently in the system. However, when one cartridge is not sufficient, loading two cartridges enables continuous printing until the print job is completed. When one cartridge empties and the other one is being used, you can replace the empty cartridge with a new one.
7. For Support material, select the number of cartridges to replace (2, 3, or 4).
Note: At least two Support material cartridges are required.
8. If the color or mechanical properties of the first 3D prints are unimportant, you can change the model materials without flushing out the current materials. To do so, continue with "Changing Model Materials Without Flushing" on page 4-19.

9. To flush out material currently in the system, choose the flushing cycle that fits your needs:



The default flushing cycle is the one used for the last material replacement.

- Economy*. This cycle can be used when replacing a light-colored model material with a darker material (such as Agilus30 Black™ or VeroBlack™) or if the exact color of the 3D print is unimportant. Use this cycle when replacing cleaning fluid with any model material.

The wizard flushes the system with the minimum amount of material needed to ensure that 3D prints have the mechanical properties of the new material.

- Full*. Use this cycle when the 3D print must have the *exact color* of the new material.

The wizard thoroughly flushes the feed tubes and print heads needed for printing, based on your selections in the previous screens.



There are additional settings that you can select for special purposes (see "Advanced Settings"). If necessary, click **Advanced Settings** before clicking **Next**.

10. Click **Next** to begin the material replacement process in the printer.

The *Cartridge Positioning* screen appears, showing you the new location of all cartridges in the material cabinet.

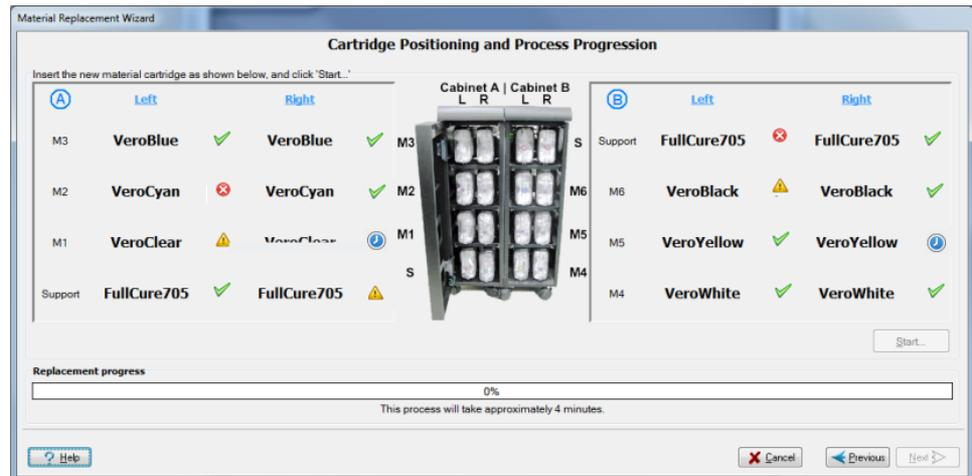

Figure 4-14 Cartridge placement

Symbols:

- ✓ The correct cartridge is in this slot.
- ✗ No cartridge (or the incorrect cartridge) is in this slot.
- ⚠ The cartridge in this slot has insufficient weight to complete the material replacement process.
- ⌚ The expiration date of the cartridge in this slot has passed.

11. Replace material cartridges as necessary, according to the instructions in the wizard screen.

12. Click **Start**.

13. Read the warning message, and click **OK**.



If you continue, you must complete the material replacement process before you can produce 3D prints. To replace material cartridges at another time, click **Cancel**. If you continue (by clicking **OK**) and you do not complete the process, you will need to run the wizard again before producing 3D prints.

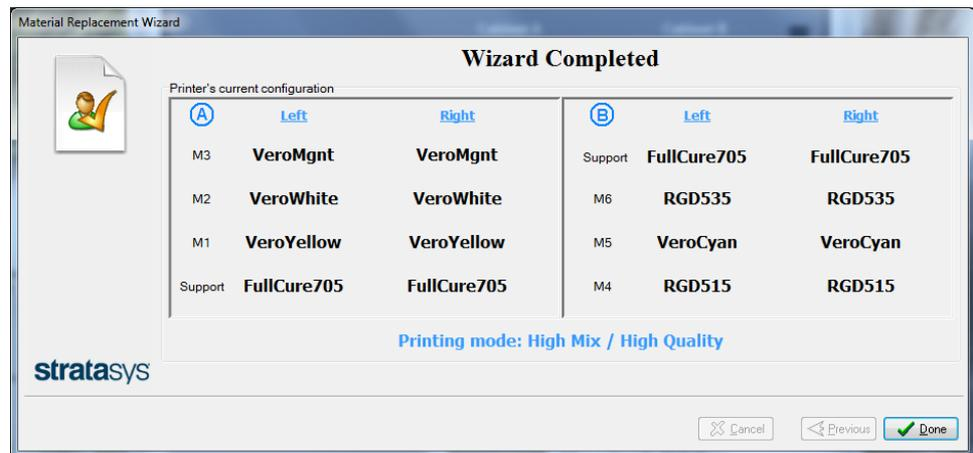

Figure 4-15 Final wizard screen

14. In the final wizard screen, click **Done**.

The printer-control application is automatically updated, and it restarts.

When it opens, the interface displays the new material(s).

The interface in the job preparation application is also updated, and it displays the new material(s).

15. Inspect the area around the purge unit and clean it, if necessary.



Before printing, you need to run the Head Optimization wizard in these cases:

- after replacing Vero with Digital ABS or Agilus30 model materials (and the reverse)
 - after changing the type of Support material (SUP705/705B/706/706B)
 - after replacing the Support material with cleaning fluid (and the reverse)
- See "Optimizing (Calibrating) Print Heads" on page 4-56

Changing Model Materials Without Flushing

You can change the model materials without flushing. Use this option when the color or mechanical properties of the 3D print are unimportant.

To change model materials without flushing:

1. In the *Material Replacement Options* screen, click **Advanced Settings**.
2. In the *Advanced Settings* screen, select **Manual slot selection** and click **Apply**.



Figure 4-16 Manual slot selection

3. When the *Material Replacement Options* screen opens, select the *Replace materials without flushing* check box and click **Next**.

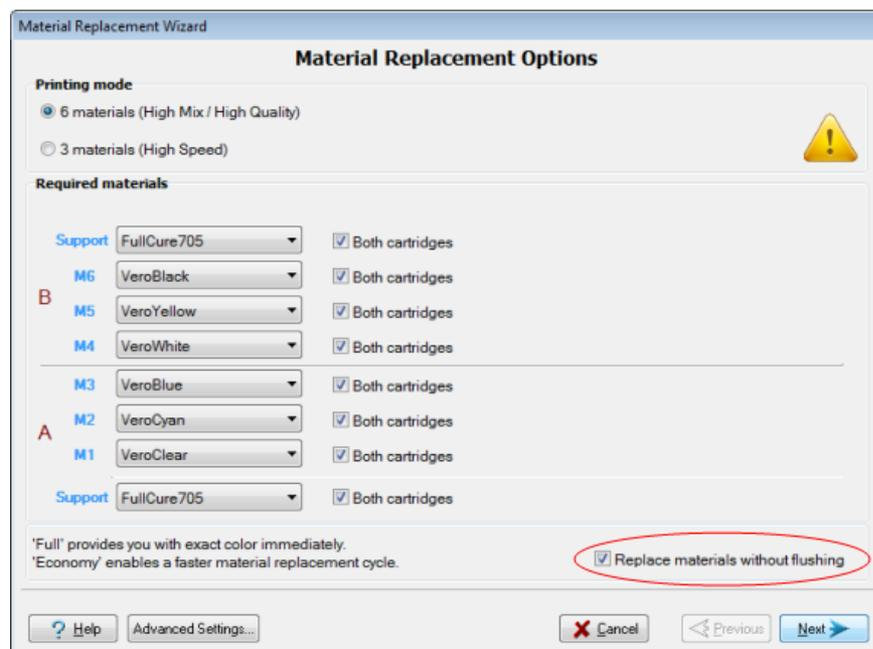

Figure 4-17 Replace materials without flushing

4. In the confirmation message that appears, click **Yes** to continue.

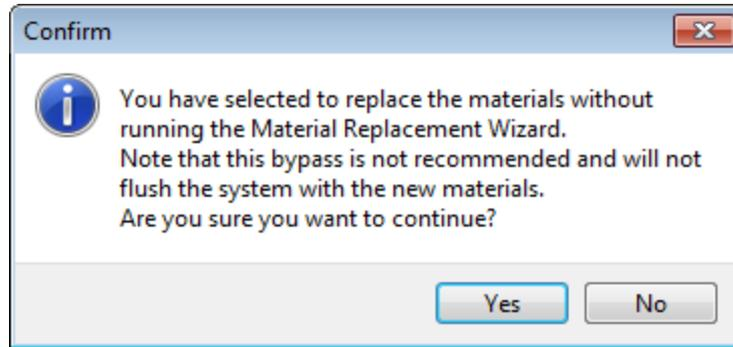

Figure 4-18 Replace without flushing confirmation message

5. In the *Cartridge Positioning and Process Progression* screen, click **Start**.

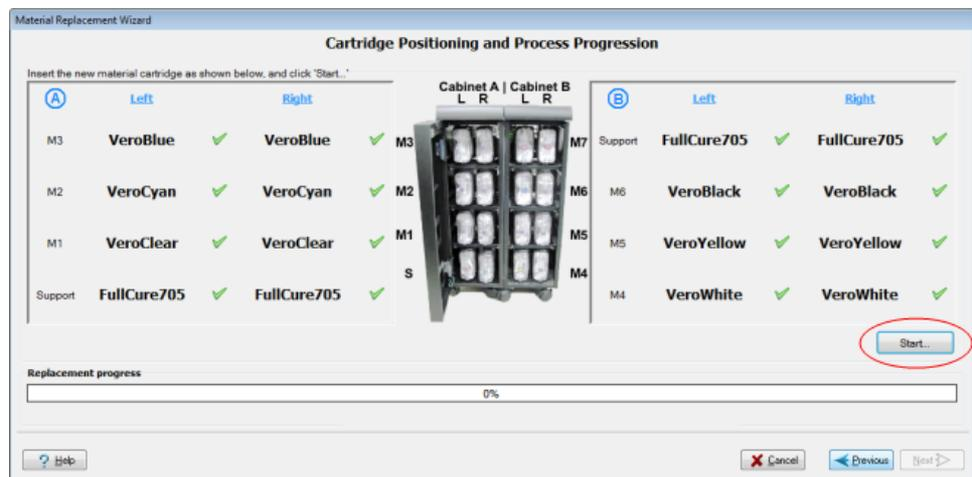

Figure 4-19 Cartridge Positioning and Process Progression screen

6. Read the Warning message that appears, and click **OK** to continue.

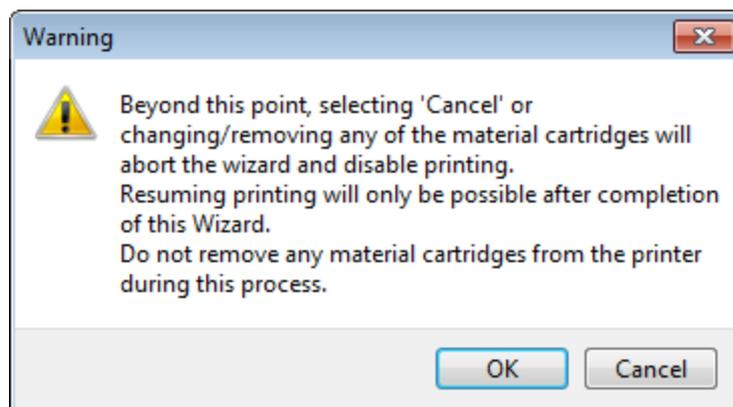

Figure 4-20 Warning message

Material replacement begins.

Printing With Bio-Materials

To ensure the bio-compatibility of printed parts when changing from standard printing materials to bio-compatible materials, follow the instructions for loading the relevant material. To download the required document, search for "Biocompatibility Requirements" on the [Stratasys Support Center](#).

Advanced Settings

The *Advanced Settings* dialog box enables you to configure the Material Replacement wizard for special purposes. If necessary, click **Advanced Settings** in the *Material Replacement Options* screen before clicking **Next**.

Positioning

By default, *Automatic slot selection* determines the best slot locations for the cartridges in the material cabinet, based on materials currently in the system. This ensures minimum flushing of materials currently loaded.

Select **Manual slot selection**—

- if there is a special need to load cartridges in certain slot locations.
- if you only want to change one of the cartridges for a given material channel.



Some materials cannot replace certain other materials. If you attempt to do so, the wizard notifies you.

To select the slots for the cartridges manually:

1. In the *Material Replacement Options* screen, click **Advanced Settings**.
2. In the *Advanced Settings* screen, select **Manual slot selection**, and click **Apply**.



Figure 4-21 Manual slot selection

- In the *Material Replacement Options* screen, **Both cartridges** is selected for each position. To print with only one of the cartridges, clear the check box and then select either the left (L) or the right (R) cartridge.

Note: When changing Support material, select **at least two** Support material cartridge slots—one from A (either L or R) and one from B (either L or R).

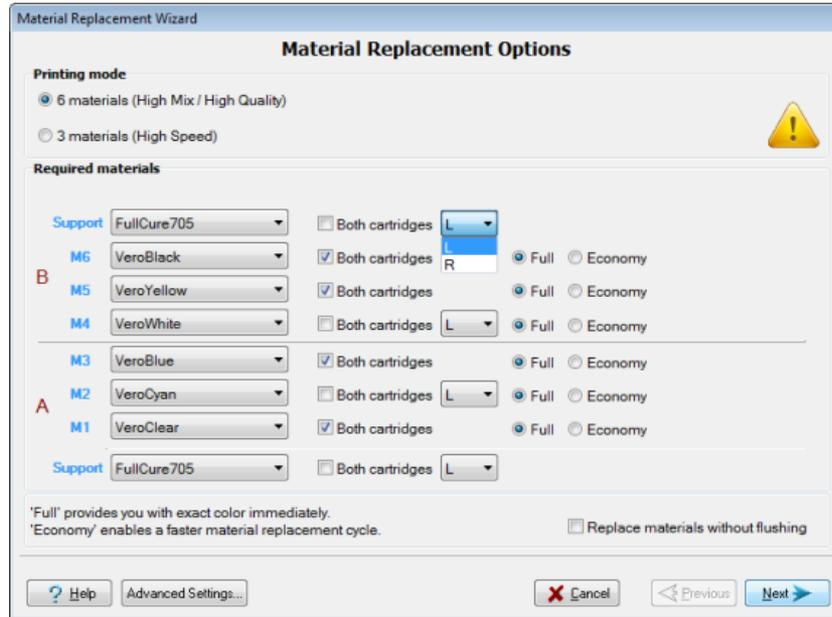

Figure 4-22 Manual cartridge selection

When printing in High Speed mode (three materials), the same material is used in both sections of each print head. The material selected for one of the cartridge slots is also used in the other print head channel.

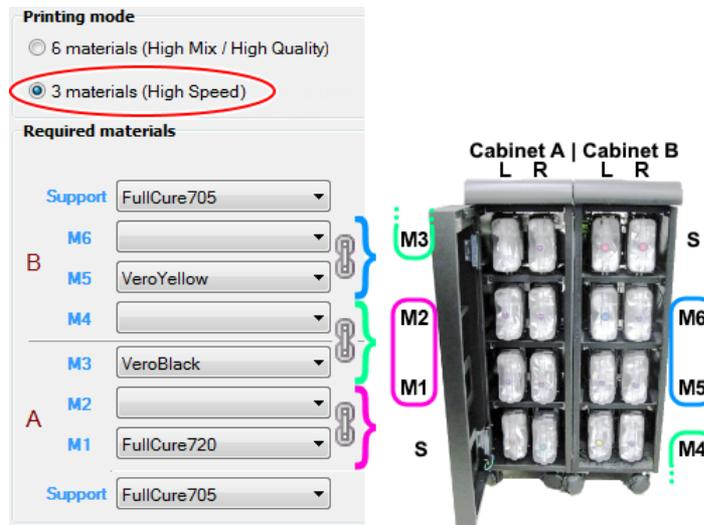

Figure 4-23 Manual cartridge selection—3 model Materials

4. After selecting the materials for the appropriate cartridge slots, the *Cartridge Positioning* screen appears. Place the cartridges in the materials cabinet as shown in this screen.

Additional Flushing Cycles

The flushing cycle you select in the *Material Replacement Options* screen determines how thoroughly to flush out material currently in the system. After selecting the *Economy* cycle and completing the wizard, you might decide that you require a more thorough flushing, to ensure accurate colors. Or, you may notice that the 3D prints are not satisfactory because they contain traces of the previous material. If so, you can flush out more material, so that the next print job will be printed with pure material.

To perform additional flushing cycles:

- In the *Advanced Settings* screen, select **Enable "flush again" options** and click **Apply**.



Figure 4-24 Enable flush again options selected

The *Material Replacement Options* screen appears, where you can select the material(s) you need to flush again.

Keeping the Printer in Idle Mode

Between printing jobs, the printer can be left unused for up to one week. If the printer will not be used for more than a week, use the Shutdown wizard to automatically perform the procedures that must be done before turning off the printer (see "Shutting Down the Printer" on page 4-27).

When the printer stops printing, the printer software automatically reduces the temperature of the print heads, as follows:

After printing stops	Mode	Change in heating of print heads
first 15 minutes	Standby 1	no change
next 1 minute	Standby 2	-----
after Standby 2	Idle	heating stopped

Note: The printer mode is indicated in the upper left of the main printer interface screen (see the figures on pages 4-4, and 4-9).

If, after printing a job, you know that the printer will not be used for 16 minutes or more, you can immediately turn off the heating of the print heads by putting the printer into Idle mode.

To put the printer into Idle mode:

- From the *File* menu (in the printer interface) click **Exit**.

Note: The printer remains in Idle mode until you open the printer application and begin printing again.



When the printer is in Idle mode, do **not** turn it off. It can remain in this mode—with the cover closed—for up to a week. For longer periods, shut down the printer by running the Shutdown wizard (see "Shutting Down the Printer" below).

Setting the Cartridge Expiration Alert

The printer application records the expiration dates for each loaded cartridge. You can display the Cartridge Expiration Date screen from the Options menu.

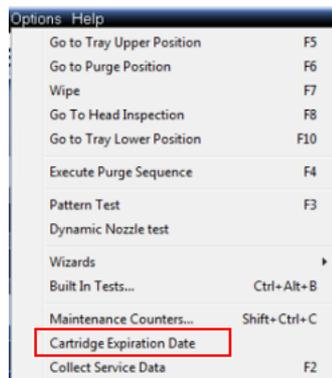

Figure 4-25 Options menu

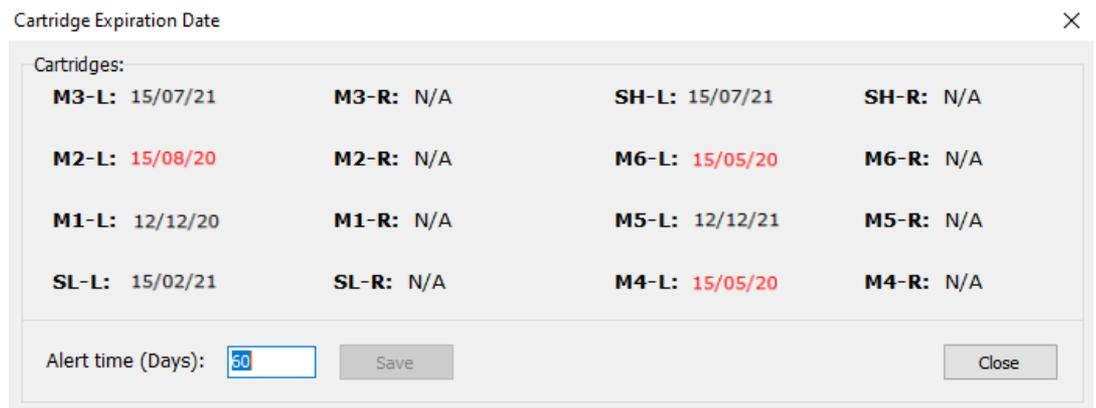

Figure 4-26 Cartridge Expiration Date screen

By default, the expiration indicator is set to display 60 days prior to the cartridge expiration date. Expiration dates that are within this time period are displayed in red in the Cartridge Expiration Date screen. In addition, in the main screen, this is indicated near the relevant cartridge.



Figure 4-27 Cartridge expiration alert indicator in main screen

If this cartridge expiration indicator appears, you can display the *Cartridge Expiration Date* screen by clicking on it.

To change the cartridge expiration alert at an earlier or later time, in the Cartridge Expiration Alert screen, enter the desired number of days, and click **Save**.

Shutting Down the Printer

You only need to shut down the printer if it will not be used for 30 days or more. Otherwise, the printer can remain on, in *Idle* mode. However, if there is a need to turn off the printer sooner, use the Shutdown wizard to automatically perform the necessary processes before turning off the printer.



The Shutdown process flushes printing materials from printer components. To avoid flushing out valuable material, make sure to print at least once a week. Many printer operators use this opportunity to print customer samples or test parts.

Before running the wizard, empty the waste container. A full waste container can cause the wizard to cancel or freeze.

To properly shut down, the printer needs to perform several processes. These are controlled by the Shutdown wizard. **Except for immediate servicing, do not attempt to shut down the printer by simply closing the computer interface (the printer-control application), and never disconnect power to the printer before completing this wizard.**



Caution

Turning off the printer for an extended period without first running the wizard can cause serious damage to print heads and other expensive printer parts.

Depending on the length of time the printer will not be used, you can choose between a short shutdown procedure, and a more thorough procedure.

- **Up to 30 days:** The wizard empties the print block of model and support material, to prevent leaks. This takes about 10 minutes.
- **More than 30 days:** The wizard empties the print block, then flushes the system with cleaning fluid. This takes up to 75 minutes, and you must be present to load a cleaning-fluid cartridge when instructed.

Note: Before selecting *More than 30 days*, make sure that the following cartridges are available (each containing a minimum of 250 grams):

- Three (3) Model cleaning-fluid cartridges
- One (1) Support cleaning-fluid cartridge

To run the Shutdown wizard:

1. Start the Shutdown wizard from the *Options* menu.

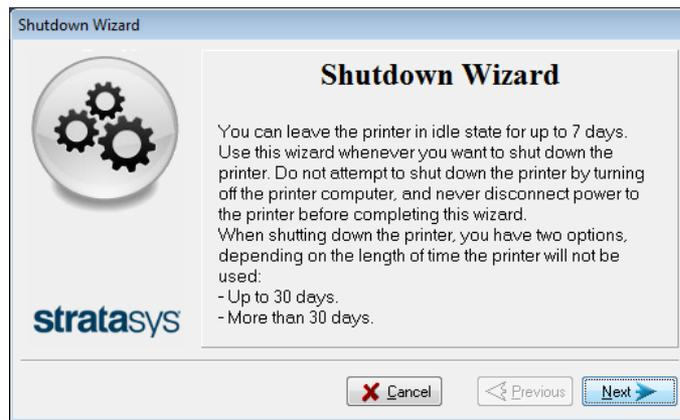

Figure 4-28 Shutdown wizard, opening screen

2. Click **Next**.
3. Select the option corresponding to the length of time that the printer will not be used—less or more than 30 days.

Note: Before selecting *More than 30 days*, make sure that cleaning-fluid cartridges are available.



Figure 4-29 Shutdown options

4. In the next screen, verify that the tray is empty and click **Next**.

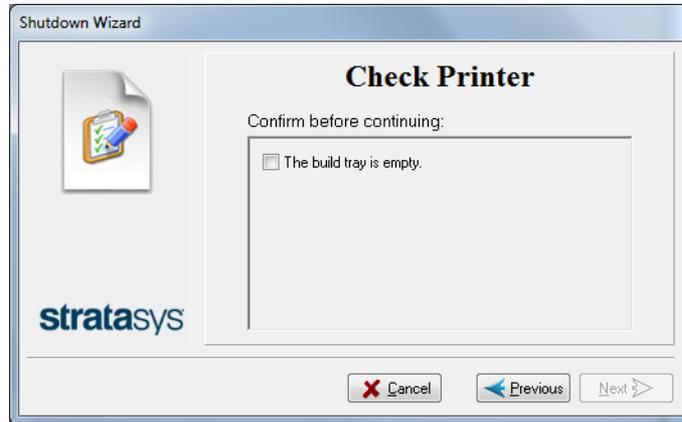

Figure 4-30 Tray status

The shutdown procedure begins.

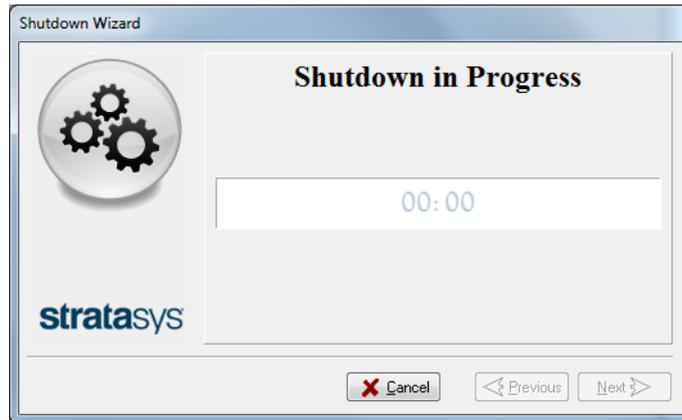

Figure 4-31 Shutdown progress

5. Follow the instructions until cleaning is completed.

- When the final wizard screen appears, close the printer-control application and shut down the printer computer.

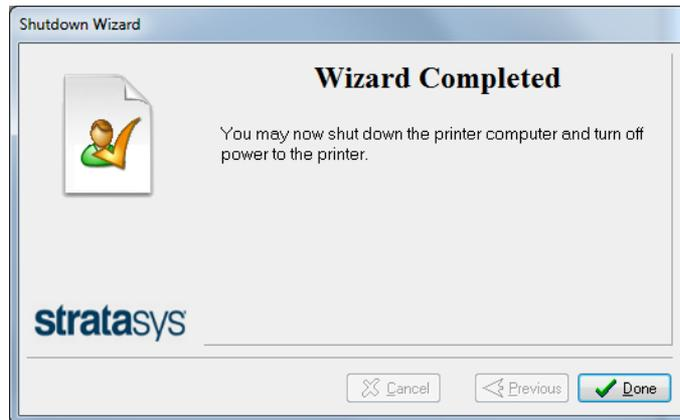

Figure 4-32 Final Shutdown wizard screen

- After the printer computer shuts down, turn off the main power switch at the back of the printer (see Figure 4-2 on page 4-3).

Maintaining the Printer

Performing routine maintenance tasks is essential for getting satisfactory results from your printer. Perform the tasks at specified intervals.

Routine Maintenance Schedule

Frequency	Task	For More Information
Before printing	Clean the UV lamp lenses.	"Cleaning the Print Heads, UV Lamp Glass, Roller and Wiper" on page 4-38.
Before / after printing	Check the UV lamp overheating indicator.	See "UV Lamp Check " on page 4-34.
Before / after printing	Routine cleaning of: <ul style="list-style-type: none"> • print heads • UV lamp glass lenses • roller surface • wiper • build tray and surrounding area 	"Cleaning the Print Heads, UV Lamp Glass, Roller and Wiper" on page 4-38.
Weekly	Clean the purge unit waste collector.	See step 11 of "Cleaning the Print Heads, UV Lamp Glass, Roller and Wiper".
Weekly	Perform the Pattern test.	See "Pattern Test" on page 4-34.
Weekly	Back up the printer's configuration files.	See "Backing up the Printer Configuration" on page 4-37
Weekly	Restart the printer computer.	
Weekly	Clean the roller waste collector.	See "Cleaning the Roller Waste Collector and Inspecting the Roller Scraper" on page 4-43.
Every 300 hours of printing (A reminder message appears.)	Calibrate the UV intensity.	See "Testing and Calibrating the UV Lamps" on page 4-73.
Every 300 hours of printing (A reminder message appears.)	Optimize the print heads.	See "Optimizing (Calibrating) Print Heads" on page 4-56.

Frequency	Task	For More Information
Monthly, and after replacing print heads	Check the alignment of the print heads.	See "Aligning the Print Heads" on page 4-49.
Monthly	Remove and clean the print-head splash shield.	See "Cleaning the Print-Head Splash Shield" on page 4-54.
Monthly	Clean debris from the Z-axis shaft with a vacuum cleaner.	
Monthly	Inspect the exhaust system (duct, fan, connections).	
Monthly	Calibrate the load cells.	See "Calibrating the Load Cells" on page 4-82.
Every 250 hours of printing in High Speed mode (3-materials) (A reminder message appears.)	Flush the print-block heater.	See "Flushing the Print-Block Heater" on page 4-83.
Every 1000 hours of printing	Replace the waste-pump tubes.	See "Replacing the Waste-Pump Tubes" on page 4-89.
About once a year (as necessary)	Replace the Material Filters.	See "Replacing the Material Filters" on page 4-96.
Every two years or every 3500 hours of printing	Preventive maintenance visit by service engineer.	Contact your Stratasys service provider.

Maintenance Counters

The printer computer application records the dates and frequency for each maintenance task. You can display the Maintenance Counters screen from the Options menu.

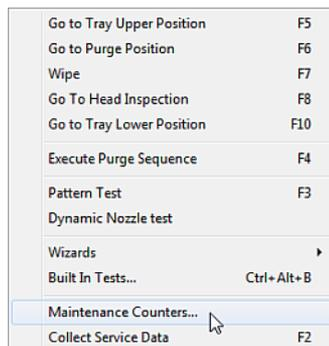

Figure 4-33 Selecting Maintenance Counters

If there is a maintenance task due, this is indicated on the main interface screen.



Figure 4-34 Maintenance Required indicator

If this indicator appears, you can display the Maintenance Counters screen by clicking on it.

 A screenshot of the 'Maintenance Counters (Hours)' window. It features a table with columns for 'Item', 'Total', 'Dated', 'Warning Time', and 'User Warning'. The table lists various maintenance tasks with their respective counters, dates, and warning times. Some tasks have 'Reset' buttons and checkboxes for 'User Warning'.

Item	Total	Dated	Warning Time	User Warning
Total Printing time	0	26/11/18	N/A	
PM is Due	0	26/11/18	3500	<input type="checkbox"/> Reset
Operator Maintenance				
UV Calibration	0	26/11/18	300	<input checked="" type="checkbox"/>
Cleaning wizard	0	26/11/18	170	<input checked="" type="checkbox"/>
Pattern Test	0	26/11/18	170	<input checked="" type="checkbox"/>
Roller Bath Inspection	0	26/11/18	170	<input type="checkbox"/> Reset <input checked="" type="checkbox"/>
Head Alignment	0	23/05/19	300	<input checked="" type="checkbox"/>
Load Cell Calibration	0	26/11/18	3500	<input checked="" type="checkbox"/>
Restart Computer	162	26/11/18	720	<input type="checkbox"/> Reset <input checked="" type="checkbox"/>
HDW HS	0	26/11/18	300	<input checked="" type="checkbox"/>
HDW HQ	0	26/11/18	300	<input checked="" type="checkbox"/>
HDW HM	0	26/11/18	300	<input checked="" type="checkbox"/>
HDW SHS	0	26/11/18	300	<input checked="" type="checkbox"/>
Max Sleep Chnl Time	0	26/11/18	N/A	<input type="checkbox"/> Reset <input checked="" type="checkbox"/>

Figure 4-35 Maintenance Counters screen



The Maintenance Required indicator appears by default for most operator-performed maintenance tasks. The check box under “User Warning” controls whether or not it appears when a particular task is due.

For maintenance tasks that are controlled by wizards, the dates and printing times are reset automatically when the relevant wizard is run and completed successfully. Manual maintenance tasks (for example, roller inspection and

wiper replacement) are reset by clicking the reset button in the Maintenance Counters screen.

UV Lamp Check

A heat-sensitive label is fixed to the UV lamp covers as a warning against overheating. Its center changes from white to black if the temperature of the cover reaches 65°C (150°F). If this occurs, do not use the printer, and call your service provider. As a precaution, it is recommended that you check the label before and after printing.

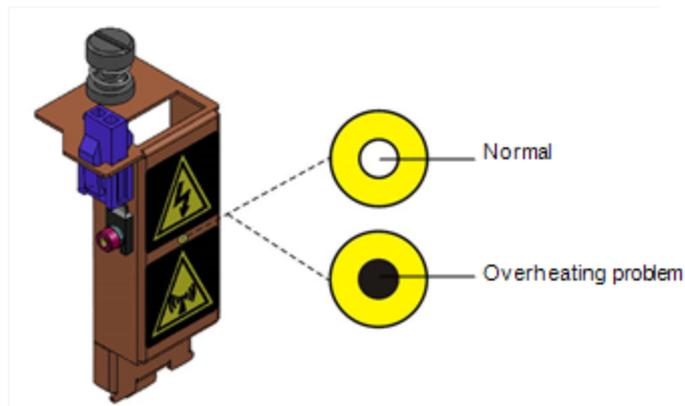

Figure 4-36 Heat-sensitive label on UV lamp cover



If the UV lamp continues to overheat, and the temperature around the lamp reaches 90°C (194°F), a heat fuse turns off the electricity to the power to the UV lamp and the motors for the X, Y, and Z axes. In the unlikely event that this occurs, the printer cannot be used until it is serviced by an authorized service engineer.

Pattern Test

The pattern test is the basic verification of the printer's ability to produce quality 3D prints, since it demonstrates the condition of the nozzles in the print heads. Make sure, therefore, that you perform this test weekly, and whenever you suspect a printing problem.

To perform the pattern test:

1. Make sure that the build tray is empty.
2. Prepare a sheet of pink paper, A-4 or Letter size.
3. In the printer, tape the pink paper to the surface left of the build tray.
4. Press **F3**, or open the *Options* menu and select **Pattern Test**.

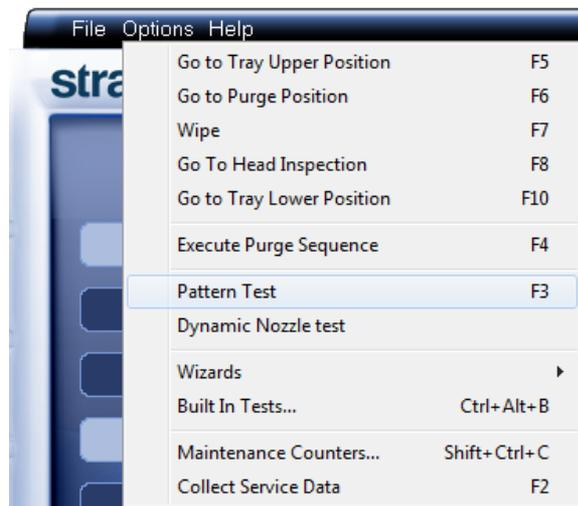

Figure 4-37 Selecting Pattern Test

5. Click **Yes** in the *Confirm* dialog box to begin.

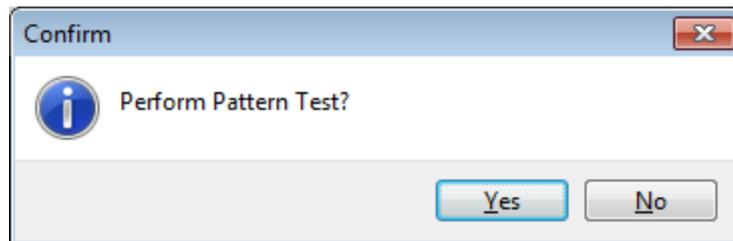

Figure 4-38 Pattern Test confirmation

6. If the build tray is *not* clear, click **No** in the following dialog box.

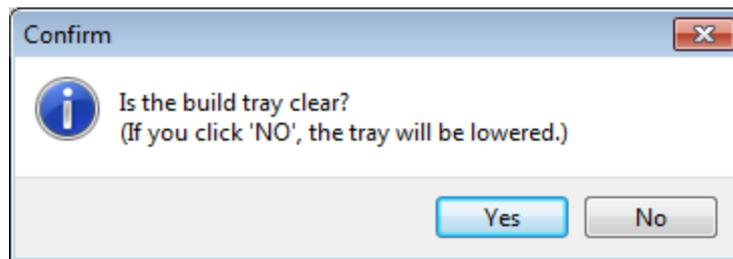

Figure 4-39 Build tray (Z) level adjustment

The build tray is lowered to prevent damage to parts on the tray.

The printer prints a series of lines on the test paper (see next figure).

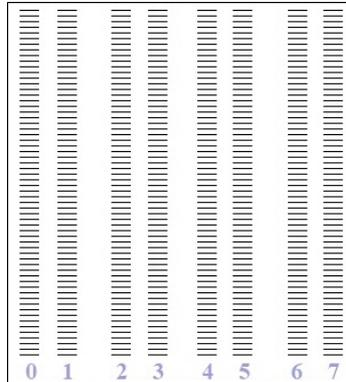

Figure 4-40 Sample Pattern Test

7. Carefully inspect the test paper to see if there are missing lines.
Too many missing lines, especially if they are in the same area, indicates that the quality of printing when producing 3D prints will be poor. If this is the case, see "Improving Print Quality" on page 4-38.
Note: Acceptable 3D print quality is subjective, and depends on the type and scale (size) of the 3D prints produced. As a rule, however, more than 10 missing lines in one area of a column is considered unacceptable.



If you do not see many missing lines, but you suspect that there are faulty nozzles in a print head, you can print samples to inspect. See "Dynamic Nozzle Test" on page 4-120.

Backing up the Printer Configuration

It is recommended that you periodically back up the printer's configuration files. In case of printer malfunction or the need to re-install the software on the printer computer, parameters can be restored from the backup. The backup also saves the printer's log and the calibration and maintenance history.

To back up the printer configuration files:

1. From the *Options* menu, select **Collect Service Data**.

or—

Press **F2**.

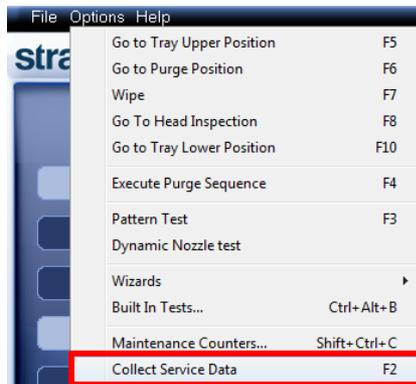

Figure 4-41 Selecting *Collect Service Data* from the *Options* menu

2. In the confirmation dialog box, click **Yes**.

A zip file is saved in this folder—

for J750 printers: \STRATASYS_J750\ServiceData

for J735 printers: \STRATASYS_J735\ServiceData

for J720 printers: \STRATASYS_J720\ServiceData

3. Copy this file to a location that is not on the printer computer (for example, a network folder or a USB drive).

Improving Print Quality

If you suspect that print quality is poor, perform the Pattern Test (see "Pattern Test" on page 4-34). If the results are poor, use the following procedure to improve print quality.

If the results of the last pattern test are poor:

1. From the *Options* menu, select **Purge Sequence**, or press **F4**.
2. In the confirmation dialog box, click **Yes**.
The print heads are purged of model and support material, and the wiper removes excess material from them.
3. Repeat the purge sequence.
4. Perform the pattern test.

If the results of the pattern test are still poor:

1. Manually clean the print heads (see "Cleaning the Print Heads, UV Lamp Glass, Roller and Wiper" below).
2. Perform the purge sequence.
3. Perform the pattern test.

If the results of the pattern test are still poor:

1. Carefully clean the print heads again, making sure there is no residue left on them.
2. Perform the purge sequence.
3. Perform the pattern test.

If the results of the pattern test are still poor:

- Optimize the print heads and replace faulty print heads, if necessary (see "Optimizing (Calibrating) Print Heads" on page 4-56).

Cleaning the Print Heads, UV Lamp Glass, Roller and Wiper

Regular inspection and cleaning of the orifice plates on the bottom of the print heads prevents print nozzles from clogging. Cleaning the roller, wiper, and UV lamp glass are also important for maintaining quality printing. A wizard adjusts printer components to enable access to these key areas, and it guides you through the cleaning procedure. To maintain the printer in optimum condition, run the wizard after every print job, when you remove the 3D print from the build tray. This procedure takes about 20 minutes.



Before running the wizard, empty the waste container. A full waste container can cause the wizard to cancel or freeze.

To clean the printer components:

1. Prepare—
 - 90% isopropanol (IPA—*isopropyl alcohol*) or ethanol (*ethyl alcohol*)
 - disposable cleaning gloves
 - a supplied 3M sanding sponge
 - a supplied cleaning cloth or equivalent
 - a mirror
2. Start the Cleaning wizard from the *Options* menu.



Figure 4-42 Options > Wizards menu

3. Make sure that the build tray is clear (empty), and close the cover. Confirm this in the wizard screen and click **Next**.

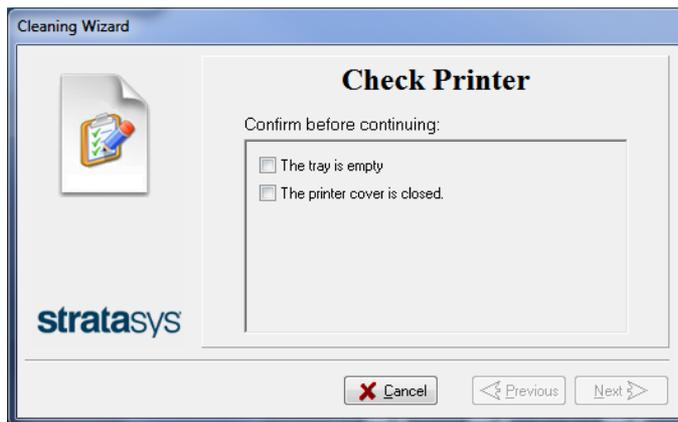

Figure 4-43 Preparation check

The printer moves components to the cleaning position.

4. When the following screen appears, open the printer.

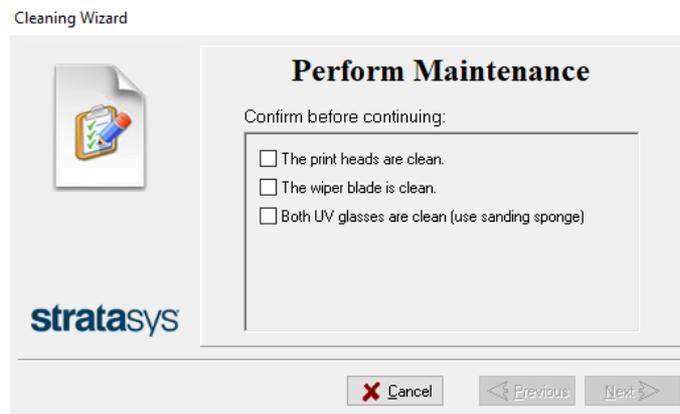

Figure 4-44 Wizard screen during cleaning tasks



Warning: Hot Surface

The print head orifice plates (bottom surface) may be hot. Do not touch them with your bare hands, and proceed with caution.

5. Place the mirror on the build tray.
6. Put on the gloves.



Caution

Uncured printing material on the print heads might cause skin irritation. Use disposable cleaning gloves to protect your hands.

7. Soak the cleaning cloth with alcohol.

- Clean the orifice plates, with a back-and-forth motion. Use the mirror to make sure that you have removed all of the residue material.

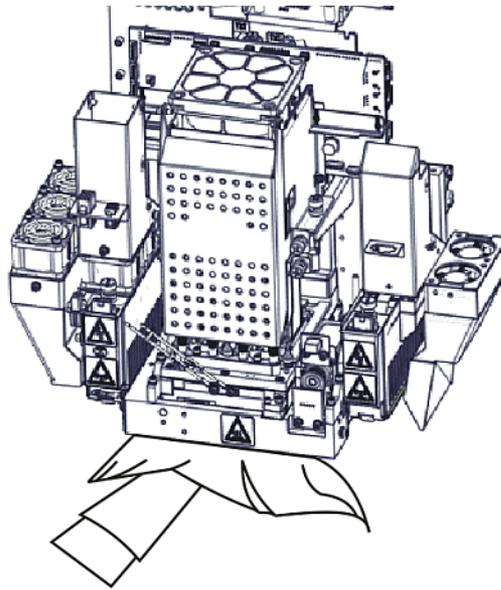

Figure 4-45 Cleaning the heads



Once a month, remove and clean the print-head splash shield. (See step 4 on page 4-55.)

- Using the supplied cleaning sponge, clean the glass lens on both UV lamps.
- Using the alcohol-soaked cleaning cloth, remove any material remaining on the wiper and the surrounding area.
- Remove any pieces of waste material collected in the purge unit. If necessary, remove the waste collector to clean it. Wipe the rubber seal.

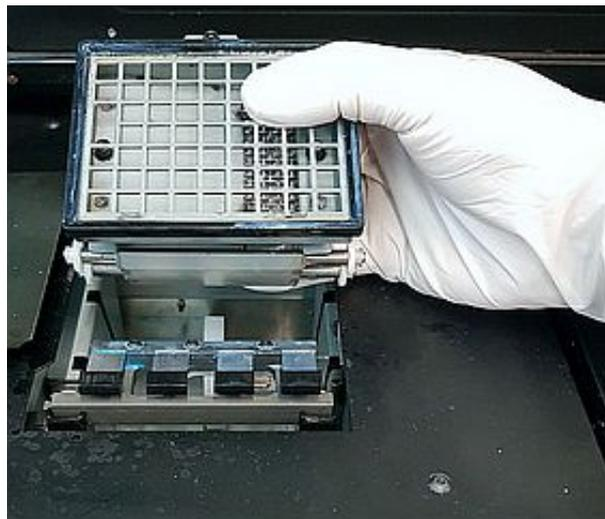

Figure 4-46 Removing the purge unit waste collector

Note: When returning the waste collector to the purge unit, make sure to insert it as shown.

12. Inspect the wiper.

If the wiper is scratched, torn or worn, or if you cannot clean it completely, replace it.

- a. Grasp it and pull it up and out of its bracket.
- b. Insert the new wiper blade, making sure that it is straight and secured well on both sides.

13. Select the confirmation check boxes in the wizard screen (see Figure 4-44) and click **Next**.

14. Activate the roller, so that it rotates while you clean it.

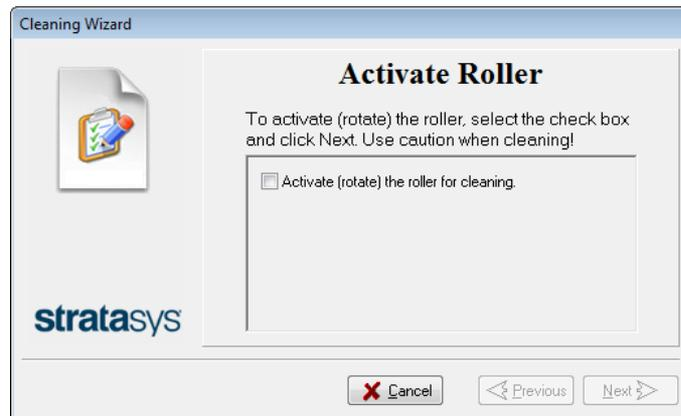

Figure 4-47 Roller-rotation activation

15. With a cleaning cloth soaked with alcohol, clean the roller surface, as it is rotating.



Caution

Use caution when cleaning the rotating roller. Use a cleaning cloth or the supplied UV sanding sponge.

16. When the roller is clean, select the confirmation check box in the wizard screen and click **Next**.



Figure 4-48 Clean-roller confirmation

The roller stops rotating when you click **Next**.

17. Remove the cleaning materials from the printer and close the printer cover.
18. Select the confirmation check boxes in the wizard screen and click **Next**.
The head-purge cycle begins. When this is complete, the final wizard screen appears.

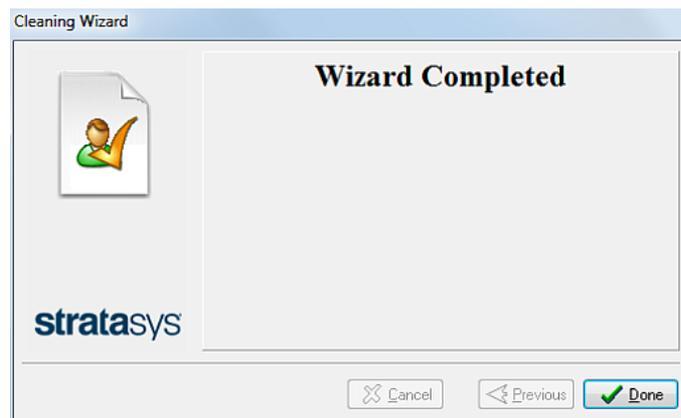

Figure 4-49 Cleaning wizard—final screen

19. Click **Done** to close the wizard.

Cleaning the Roller Waste Collector and Inspecting the Roller Scraper

The roller waste collector removes waste material scraped from the roller. Suction removes this waste to the printer's waste container.

This assembly should be cleaned weekly to prevent a blockage in the tubes leading to the waste container, so that waste material does not overflow into the printer.

To clean the roller waste collector:

1. Prepare—
 - M2.5 and M2 Hex (Allen) keys
 - disposable cleaning gloves
 - 90% isopropanol (IPA—*isopropyl alcohol*) or ethanol (*ethyl alcohol*)
 - cleaning cloth
 - cotton swabs (Q-tips or similar)
 - mirror
 - flashlight
2. From the *Option* menu, select **Go to Head Inspection Position**.
3. Put on the gloves.
4. Remove the right UV-lamp assembly:
 - a. Disconnect the UV power cable and the fan power cable.

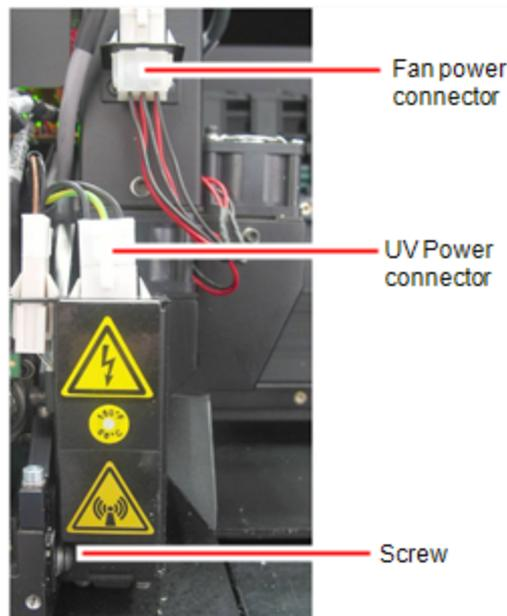

Figure 4-50 Disconnecting the right UV assembly

- b. Remove the screw that secures the right UV lamp, and then pull and lift up the UV lamp.

5. Loosen the two screws securing the suction tube on the print block.

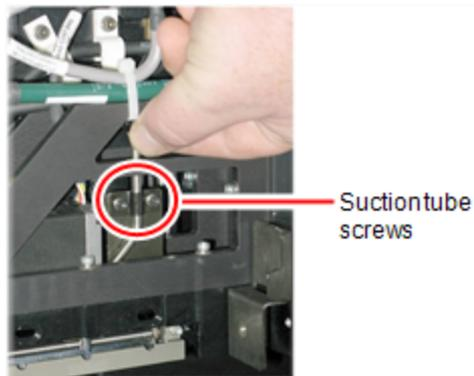

Figure 4-51 Lifting the suction tube

6. Lift the suction tube to secure it in a raised position.
7. Remove the two screws securing the covering of the roller waste collector and remove it.



Be very careful to save the covering screws. These are special screws; if they are lost, you need to order replacements.

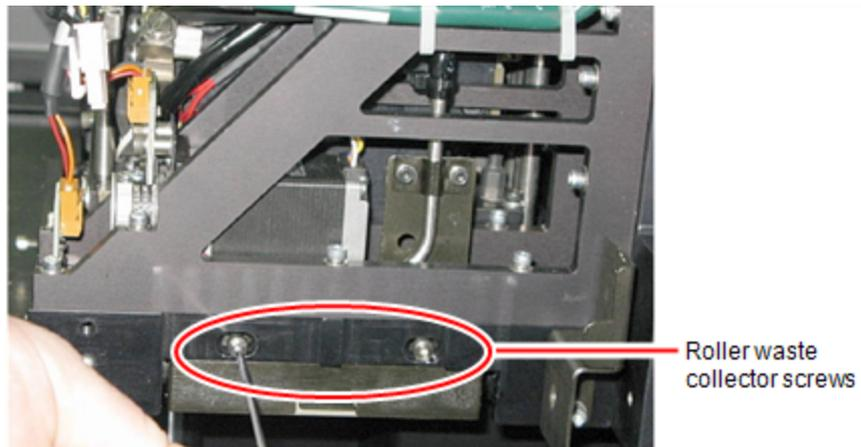

Figure 4-52 Removing the roller waste collector screws

8. Remove the covering by pulling it out, and then lower it.

9. Clean the roller waste collector and the scraper blade surface using cotton swabs. Make sure to remove any remaining printing materials.



Figure 4-53 Cleaning the roller waste collector



Before replacing the covering, you can check the effectiveness of the roller scraper—see below.

To check the effectiveness of the roller scraper:

1. Put on the cleaning gloves.
2. Wet a cloth with isopropanol.
3. Use the cloth to wet the bottom of the roller.
4. Turn the roller slowly with your hand. As the blade scrapes the roller, make sure the isopropanol is spread evenly over the entire length of the blade.
5. Inspect the roller. If it is not dry, replace the blade. (See "Replacing the Roller Scraper" on the next page.)
6. Before returning the roller waste collector to the print block, make sure that the pins are clean.

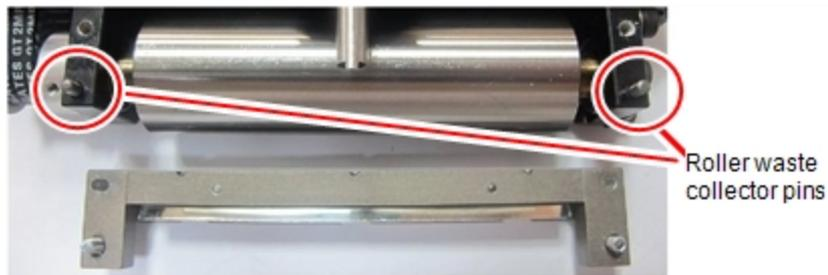

Figure 4-54 Roller waste collector pins

To re-assemble the components:

1. Return the roller waste collector to the print block and screw on the covering (see Figure 4-52 on the previous page).

2. Loosen the screws securing the suction tube.

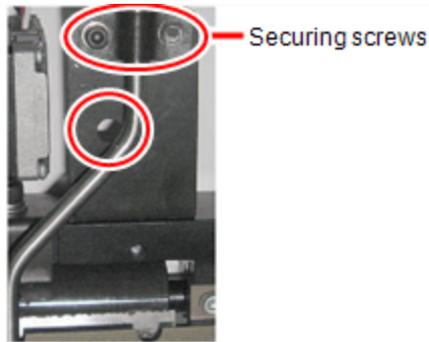

Figure 4-55 Positioning the suction tube

3. Lower the suction tube so that the hole in the panel behind the tube is visible, and tighten the screws to secure the tube.
4. Attach the right-UV-lamp assembly to the print block and reconnect the UV power and fan cables.

Replacing the Roller Scraper

You should replace the roller scraper blade—

- after 1,000 hours of printing.
- if it does not effectively keep the roller clean.



You should periodically test the effectiveness of the roller scraper when you clean the roller waste collector. See "Cleaning the Roller Waste Collector and Inspecting the Roller Scraper" on page 4-43.

To replace the roller scraper:

1. Prepare—
 - a new roller scraper blade
 - a Phillips 1x75 mm screwdriver
 - a 2.5-mm and a 2-mm hex (Allen) key
2. Remove the right UV lamp and the roller waste collector covering (see steps 4 to 7 on page 4-44).
3. Loosen the two screws securing the roller waste collector and pull it out.



Figure 4-56 Removing the roller waste collector

4. Remove the screws that secure the roller scraper assembly.

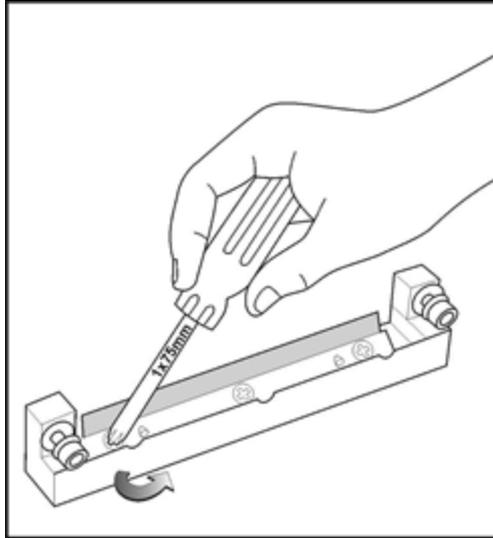

Figure 4-57 Removing the roller scraper screws

5. Remove the scraper blade and discard it.

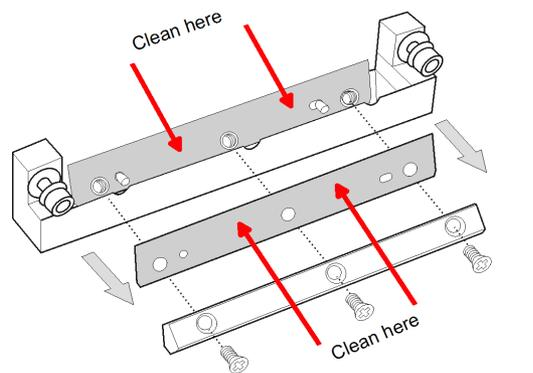

Figure 4-58 Removing the old roller scraper blade

6. Place the new scraper blade onto the pins in the holder, as shown.

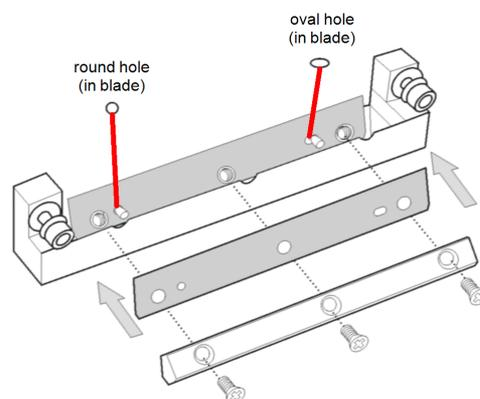

Figure 4-59 Inserting the new roller scraper blade

7. Insert and tighten the roller scraper blade screws.

Important:

- Tighten the screws in the order shown in Figure 4-60.
- Use the new screws supplied in the replacement kit

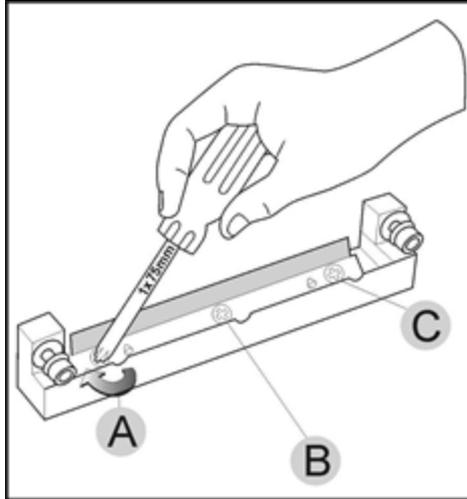

Figure 4-60 Tightening the roller scraper screws

8. After tightening the screws, inspect the blade and make sure that it is straight. If necessary, loosen the screws and tighten them again, evenly.
9. Return the roller waste collector assembly and the right UV lamp to the print block. (See steps 5 to 7 on page 4-44 in "Cleaning the Roller Waste Collector and Inspecting the Roller Scraper".)

Aligning the Print Heads

You should check the alignment of the print heads—

- once a month
- after replacing one or more heads
- if quality is not acceptable even after cleaning the orifice plate on the bottom of the print block (see "Cleaning the Print Heads, UV Lamp Glass, Roller and Wiper" on page 4-38).

This procedure takes about 20 minutes.

To check the alignment of the print heads:

1. Prepare—
 - a transparency sheet, A-4 or Letter size
 - any type of adhesive tape, to fasten the transparency sheet to the build tray
2. Start the Head Alignment wizard from the *Options* menu.

- When the following screen appears, place the transparency on the build tray—next to the left and rear edges of the tray (see below).

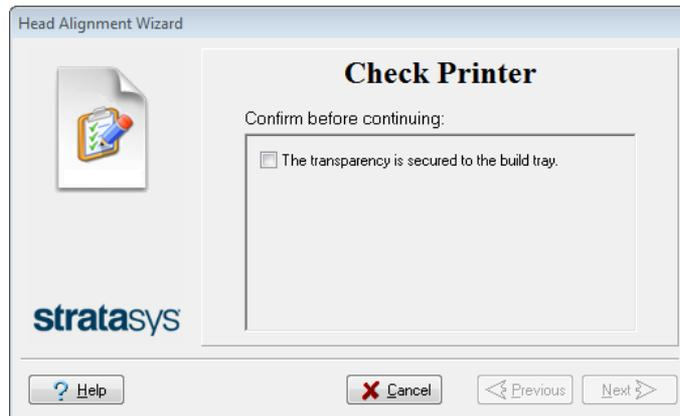

Figure 4-61 Transparency confirmation



Figure 4-62 Positioning the transparency on the build tray

- Make sure that the transparency sheet is lying flat, and tape it to the tray.
- Close the printer cover.
- In the wizard screen, select the check box to confirm that the transparency sheet is secured to the build tray, and click **Next**.

When you click **Next**, the printer prints the head alignment test on the transparency. When printing is finished, the following screen appears.

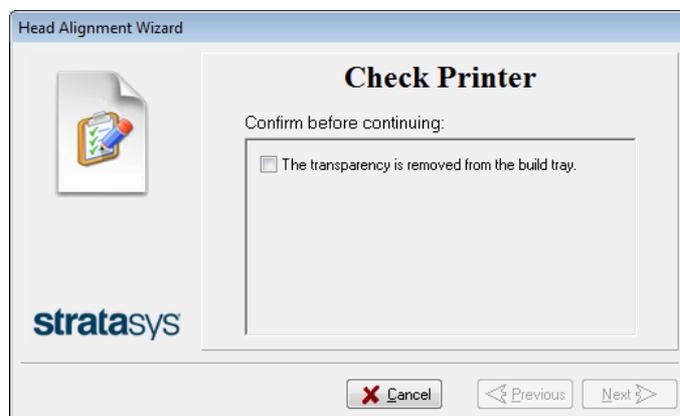

Figure 4-63 Head Alignment wizard—steps 7–9

- Open the printer and remove the transparency.

The transparency sheet is printed with sets of vertical lines in seven columns, each showing the results from a different print head.

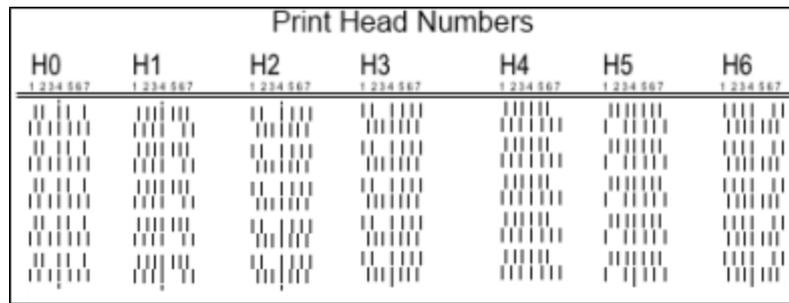

Figure 4-64 Sample head-alignment test

Note: There is no column for head H7 because its alignment is used as a reference for aligning all other heads.

8. For each column of lines, use a magnifying glass or loupe to inspect pairs of consecutive rows printed on the transparency to see where the vertical lines align.

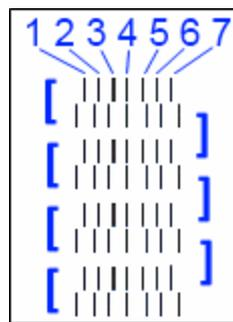

Figure 4-65 Comparing rows of alignment lines

Note: It does not matter which pair of lines you inspect, since they were all printed by the same head. Choose a pair of clearly printed lines for the inspection. (Since some nozzles may not print clearly, you may have to inspect several pairs of lines to properly view the alignment.)

Optimum head alignment is shown when the *fourth* lines in the upper and lower rows are aligned, as in Figure 4-65. In the example shown, no change to the head alignment is necessary. If other lines in the set are aligned, you need to change the alignment of that head—in the next wizard screens.

9. In the wizard screen shown in Figure 4-63, select the *Transparency removed* check box, and click **Next**.

The first in a series of alignment screens appears.

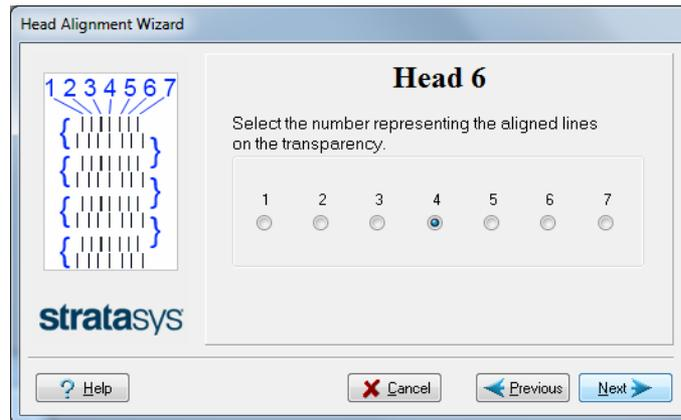

Figure 4-66 Head alignment selection

10. In the head-alignment screen, select the number that indicates which lines align in the upper and lower rows of a pair on the transparency (counting from the left) for this print head.

Note: Because the alignment of the fourth lines is optimum, the number “4” is selected, by default, in the wizard screen. This does not change the head alignment. If you select other numbers, the wizard adjusts the head alignment, accordingly.

11. Click **Next** to display the next head alignment screen, and again select the number representing the most closely aligned vertical lines on the transparency for that print head.

When you have finished aligning all of the heads, the following screen is displayed.



Figure 4-67 Parameter update confirmation

12. Continue as follows:

- To make the alignment changes in the printer, make sure that *Update system with new parameters* is selected, and click **Next**.

A message that the parameters were updated appears. For all modes, except High Quality, since the update to parameters can affect the color uniformity, it is recommended to continue directly with the Color Uniformity wizard.

- To recheck the alignment test results before making the alignment changes in the printer, click **Previous**.
- If you do not want to make alignment changes in the printer at this time, select *Keep previous parameters*, and click **Next**.

13. In the following screen, you can choose to either repeat the head alignment procedure, continue to the Color Uniformity wizard, or close the wizard.



Figure 4-68 Repeat head alignment option

- If the most closely aligned vertical lines for a print head were at either extreme, choose **Repeat the test**, then click **Next**.

The additional transparency test will show if the heads are now properly aligned, and—if not—the wizard will allow you to “fine tune” the alignment.

- For High Mix and High Speed modes, if the head alignment parameters were updated, you should “fine tune” the print heads to ensure color uniformity, especially along the part’s X-walls. To do this, choose **Run Color Uniformity Wizard** and click **Next**. The *Head Alignment Wizard Completed* screen appears. When you click **Done**, the Color Uniformity wizard opens.
- If the vertical lines for the print heads were not aligned at either extreme, or if you do not want to run the color uniformity wizard, choose *End this wizard*, then click **Next**.

Cleaning the Print-Head Splash Shield

To prevent excess printing material from accumulating around the print heads, a splash shield is installed on the bottom of the print block. Remove the shield and clean it once a month, when cleaning the print heads (see "Cleaning the Print Heads, UV Lamp Glass, Roller and Wiper" on page 4-38).

To remove the print-head splash shield:

1. Run the Cleaning wizard from the *Options* menu.
When the printer moves components to the cleaning position, the following screen appears.

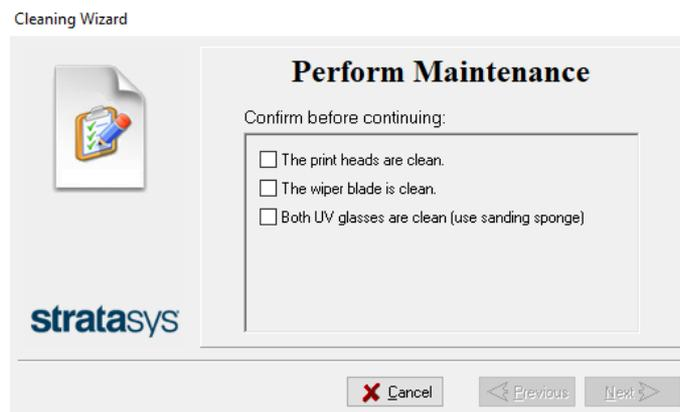

Figure 4-69 Wizard screen during cleaning tasks

2. Open the printer and place a mirror on the build tray.
3. Put on cleaning gloves.



Caution

Uncured printing material on the print heads might cause skin irritation. Use disposable cleaning gloves to protect your hands.

- Using a 2-mm hex (Allen) key, remove the screws to remove the splash shield.



Figure 4-70 Print-head splash shield installed on the print block

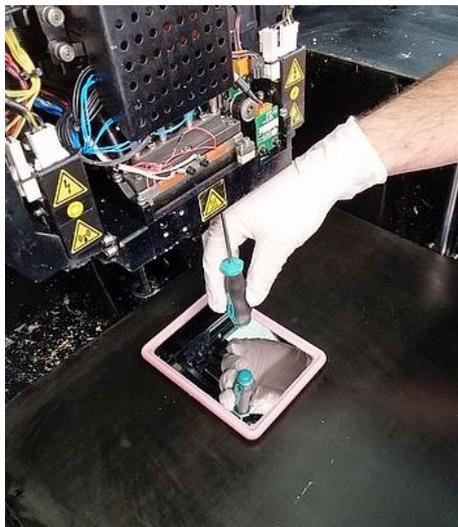

Figure 4-71 Removing the print-head splash shield



Warning: Hot Surface

The print head orifice plates (bottom surface) may be hot. Do not touch them with your bare hands, and proceed with caution.

- Soak a cleaning cloth with 90% alcohol and clean the splash shield.
- Return the splash shield to the print block and secure it with four (4) screws.

After cleaning the print heads and the splash shield, continue with step 9 in the daily cleaning routine (see "Cleaning the Print Heads, UV Lamp Glass, Roller and Wiper" on page 4-41).

Optimizing (Calibrating) Print Heads

The condition of the print heads directly affects the quality of 3D prints. To maintain optimum printing, you should routinely test the print heads, and calibrate them to the best working configuration possible by running the Head Optimization wizard every 300 hours of printing.

You also need to calibrate the print heads in these cases:

- after replacing Vero with Digital ABS or Agilus30 model materials (and the reverse)
- after changing the type of support material (SUP705/705B/706/706B)
- after replacing the support material with cleaning fluid (and the reverse)

During this procedure, you place a scale on the build tray and connect it to the printer. Printing material (resin) is jetted from each head and its weight is automatically recorded and the wizard determines how to optimize the print heads.

If, during the optimization process, the wizard determines that a print head is faulty—or that it is negatively affecting layer uniformity with the current head configuration—the wizard instructs you to replace it. If this happens, you can continue the wizard to replace the print head, or abort the wizard, to replace the head at another time.



Run the Head Optimization wizard every 300 hours of printing or whenever the condition of print heads is negatively affecting the quality of 3D prints, or if you suspect that there is a problem with one or more of the print heads.

Before running the wizard, empty the waste container. A full waste container can cause the wizard to cancel or freeze.

Note: To accurately test and calibrate print heads, they must be clean. If necessary, run the Cleaning wizard before beginning this procedure.

To test and calibrate the print heads:

1. Prepare—

- disposable cleaning gloves (any clean, powder-free protective gloves)
- pink paper
- the Missing Nozzles ruler
- the scale supplied for use in the Head Optimization wizard

Important: Before beginning this procedure, ensure that the scale is calibrated and at least partially charged.

2. Start the Head Optimization wizard from the *Options* menu.

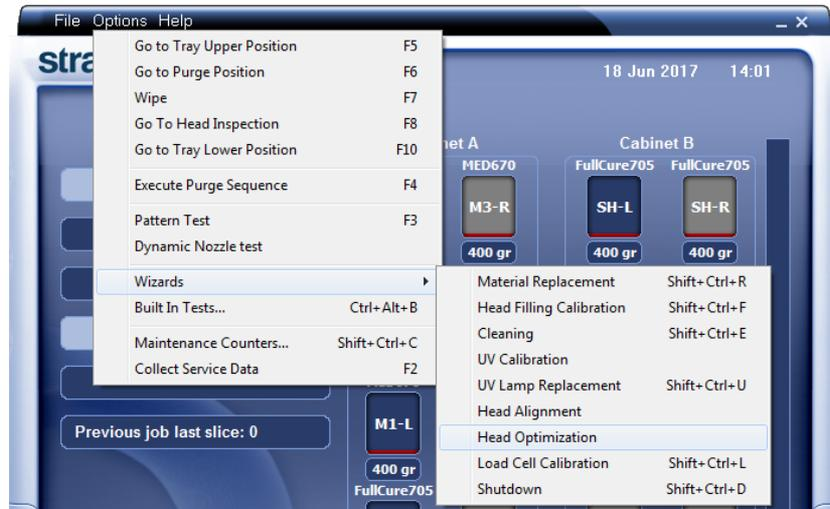

Figure 4-72 Starting the Head Optimization wizard

3. In the opening wizard screen, click **Next** to begin.
The *Wizard Conditions* screen appears.
4. Read the conditions, select **I Agree** and click **Next**.
5. In the following screen, select **Continue with Head optimization** if you have recently cleaned the print heads. Otherwise, cancel the wizard and run the Cleaning wizard.



Figure 4-73 Clean print heads screen

- In the following screen, make sure *Optimize all print heads* is selected, and click **Next**.



Figure 4-74 Procedure selection screen

- Select the printing mode for which you want to optimize the print heads and click **Next**.



Figure 4-75 Printing mode selection

- Make sure that the build tray is clear and clean, and confirm this in the wizard screen.

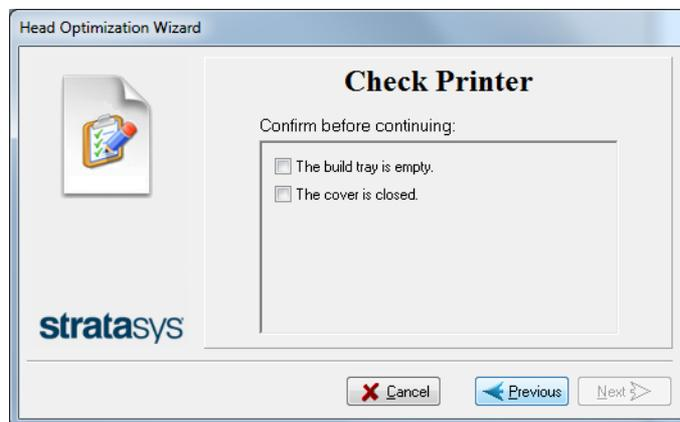

Figure 4-76 Preparing for head optimization (1)

When you click **Next**, a frame is printed on the build tray.

- When the following screen appears, open the printer and tape a sheet of pink paper to the surface left of the build tray.

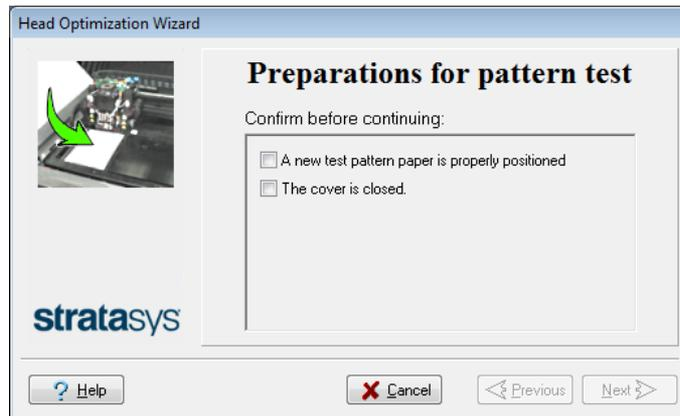

Figure 4-77 Preparing for head optimization (2)

When you click **Next**, the Pattern Test is printed on the pink paper.

- When the following screen appears, open the printer and remove the Pattern Test paper.

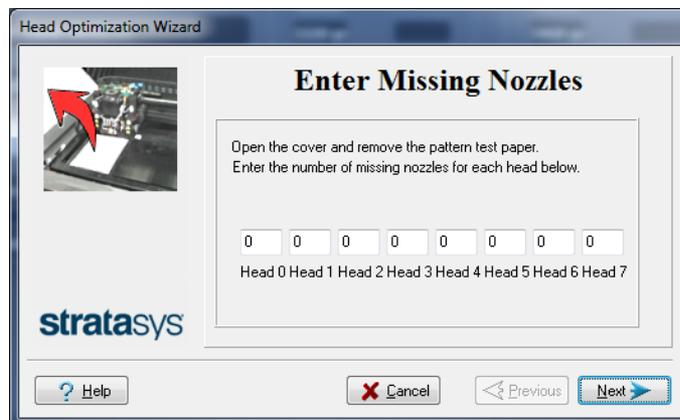

Figure 4-78 Enter Missing Nozzles screen

- Carefully inspect the Pattern Test paper with the Missing Nozzles Ruler to see if there are missing lines.

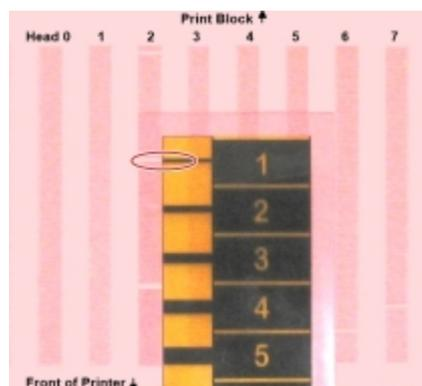

Figure 4-79 Inspecting the Pattern Test

Each missing line represents a faulty nozzle in the print head.

12. In the *Missing Nozzles* screen, enter the number of missing nozzles for each print head and click **Next**.
13. The wizard continues according to the number of missing nozzles you entered.
 - If there are too many missing nozzles for acceptable printing, the wizard instructs you to replace the defective print head(s). You can do this now, or abort the wizard.

If you are prepared to replace print heads now, the wizard guides you through the procedure when you click **Next**. Make sure you have replacement heads and the required tools (see page 4-64). Then, continue with "Preparing the Print Block" on page 4-65.

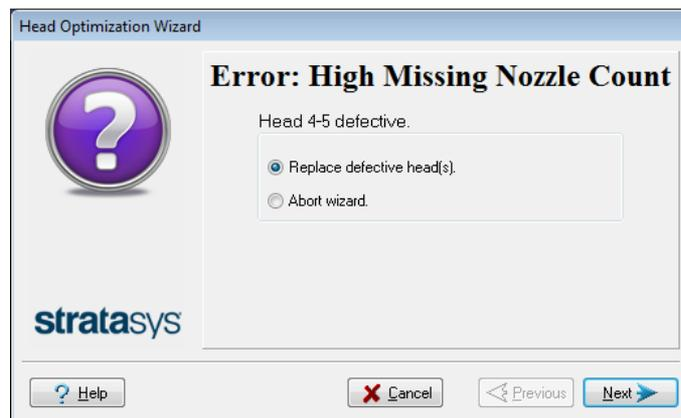

Figure 4-80 Head replacement due to missing nozzles

- If the number of missing nozzles in all print heads is acceptable, the wizard continues with the head optimization process (below).
14. Set up the scale in the printer by performing the steps listed in the wizard screen.

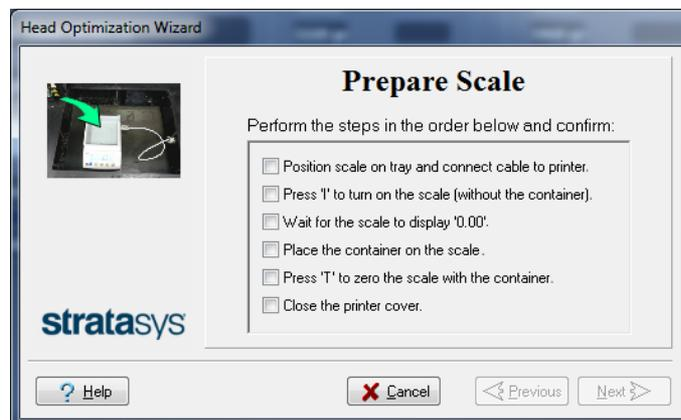

Figure 4-81 Setting up the Head Optimization scale

15. After confirming all of the items listed in the wizard screen, click **Next**.
Printing material (resin) is jetted from each head and its weight is automatically recorded. Then, the following screen appears.

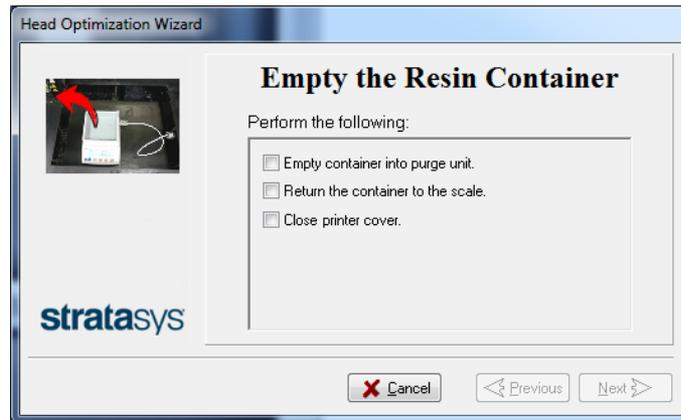

Figure 4-82 Emptying the resin container

16. Open the printer. Carefully remove the resin container from the scale and empty it into the purge unit. Then return the container to the scale.



Caution: The resin in the container is uncured

- To prevent contact with skin, wear neoprene or nitrile gloves.
- Dispose of uncured resin in accordance with applicable regulations. By emptying the container into the purge unit, the resin is stored in the printer's sealed waste container.

17. Close the printer cover, confirm the items listed in the wizard screen, and click **Next**.

The printer cures the resin in the container.

18. When the following screen appears, open the printer and remove the scale.

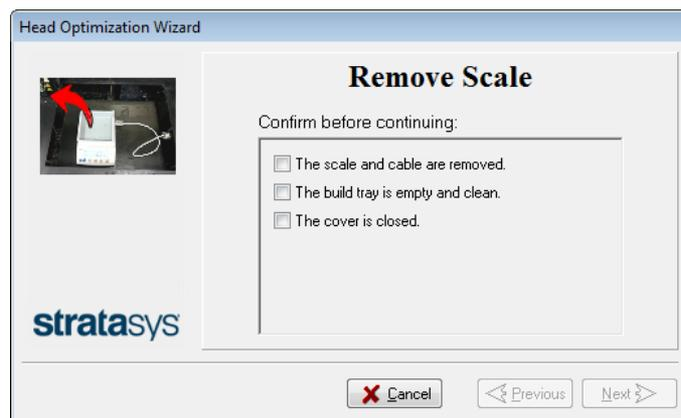

Figure 4-83 Remove Scale confirmation screen

19. Confirm the items listed in the wizard screen, and click **Next**.

The wizard uses the data collected to analyze the condition of the print heads and optimize them so they print with a uniform layer of material.

- If the heads are in satisfactory condition, the following wizard screen appears.

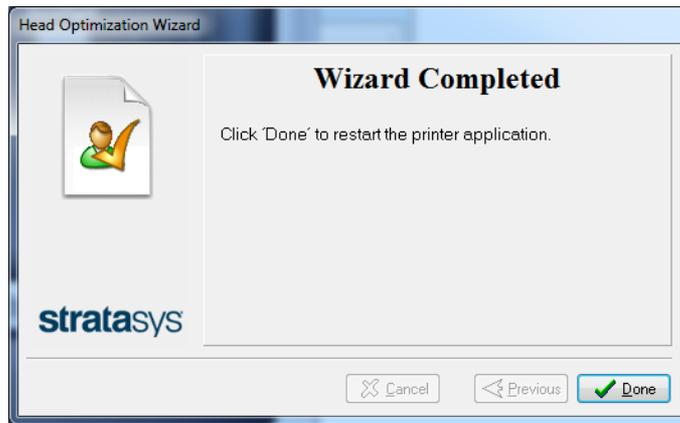

Figure 4-84 Final wizard screen, after optimizing print heads

- If the wizard determines that a print head is faulty—or that it is negatively affecting part quality with the current head configuration—you need to replace it. Indicate whether or not you want to do so now.



Figure 4-85 Defective print heads found

- Select **Replace defective head(s)** if you are prepared to replace the print heads now (see below).
- or—
- Select **Abort wizard** if you want to replace the print heads at another time.



Replace print heads only after consulting with an authorized Stratasys service provider.

To replace print heads, you need these tools and materials:

- replacement print head(s)
- 90% isopropanol (IPA—*isopropyl alcohol*) or ethanol (*ethyl alcohol*)
- disposable cleaning gloves (supplied with the print head; or use any clean, powder-free protective gloves)
- a supplied cleaning cloth or equivalent
- a mirror
- a 4-mm hex (Allen) key
- a small Phillips screwdriver
- the Missing Nozzles ruler
- the scale supplied for use in the Head Optimization wizard (Weight Test)

Important: Before beginning this procedure, ensure that the scale is calibrated and at least partially charged.

If you are replacing print heads now, the wizard guides you through the procedure when you click **Next**. Continue with "Replacing Print Heads" below.

Replacing Print Heads

The condition of the print heads directly affects the quality of 3D prints. You may need to replace a print head if one or more of the following symptoms occurs:

- The Head Optimization wizard determines that a print head is defective. (See "Optimizing (Calibrating) Print Heads" on page 4-56.)
- There are noticeable grooves in the surface of 3D prints.
- Visual inspection of the head reveals that its surface is damaged—peeling or bubbles in the nozzle area.
- The printer interface displays a warning or malfunction message relating to a print head—
 - Head Heater temperature timeout
 - Head Heater thermistor open
 - Head Heater thermistor short



Replace print heads only after consulting with an authorized Stratasys service provider.

The Head Optimization wizard guides you through the procedure of replacing a print head, and configures printer components to enable you to perform it. Only replace a print head with the aid of the wizard.

The entire print-head replacement procedure takes about 45 minutes, and consists of the following phases:

- A. Identifying the head(s) needing replacement.
This is normally done by the Head Optimization wizard. Otherwise, evidence of physical damage to the head surface or a malfunction message indicates which head needs replacing.
- B. Preparing the print block for head replacement.
This is done automatically when you run the wizard.
- C. [Removing the defective print head.](#)
- D. [Installing a new print head.](#)
- E. Optimizing the print heads (done automatically by the wizard).
- F. [Performing head alignment.](#)

To replace a print head:

1. Prepare—
 - replacement print head(s)
 - 90% isopropanol (IPA—*isopropyl alcohol*) or ethanol (*ethyl alcohol*)
 - disposable cleaning gloves (use clean, powder-free gloves)
 - lint-free cleaning cloths
 - a mirror
 - a 4-mm hex (Allen) key
 - the scale supplied for use in the Head Optimization wizard (Weight Test)
 - the Missing Nozzles ruler

Important: Make sure that you have these items and that the scale is calibrated and at least partially charged before continuing.

2. Start the Head Optimization wizard from the *Options* menu (see the figure on page 4-56).
3. In the opening wizard screen, click **Next** to begin.
The *Wizard Conditions* screen appears.
4. Read the conditions, select **I Agree** and click **Next**.

5. In the following screen, select **Continue with Head optimization** if you have recently cleaned the print heads. Otherwise, cancel the wizard and run the Cleaning wizard.



Figure 4-86 Clean print heads screen

6. In the following screen, select **Replace faulty heads**, and click **Next**.



Figure 4-87 Procedure selection screen

Preparing the Print Block

7. Select the print head(s) needing replacement, and click **Next**.



Figure 4-88 Head selection screen

The printer heats and empties the print block, and prepares the printer.
(This should take up to 15 minutes.)

The following screen appears when the printer is ready for you to replace print heads.

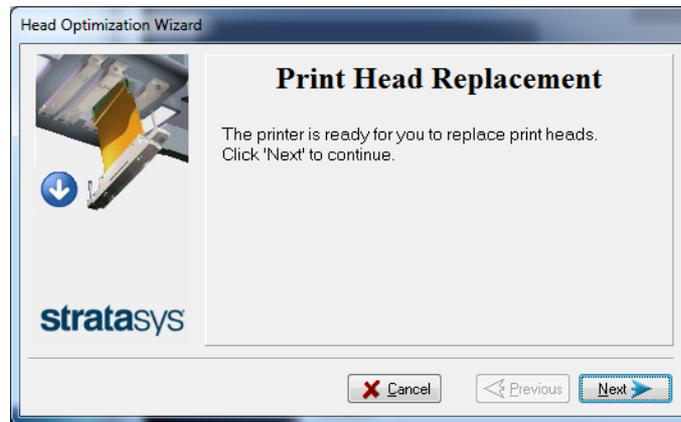

Figure 4-89 Printer ready for head replacement

8. Put on the protective gloves and open the printer cover.
Note: The printer disconnects power to the heads for your safety.

Removing the Defective Head

9. On the front of the print block, loosen the screws that secure the cover protecting the print-head driver cards.

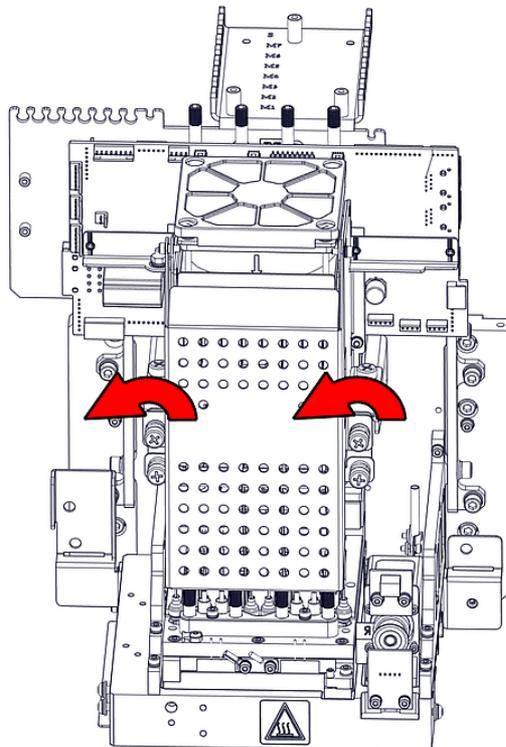

Figure 4-90 Loosening the driver-card cover screws

10. Lift up the cover.

11. Loosen the screws that secure the driver-card bracket, and lower the bracket.

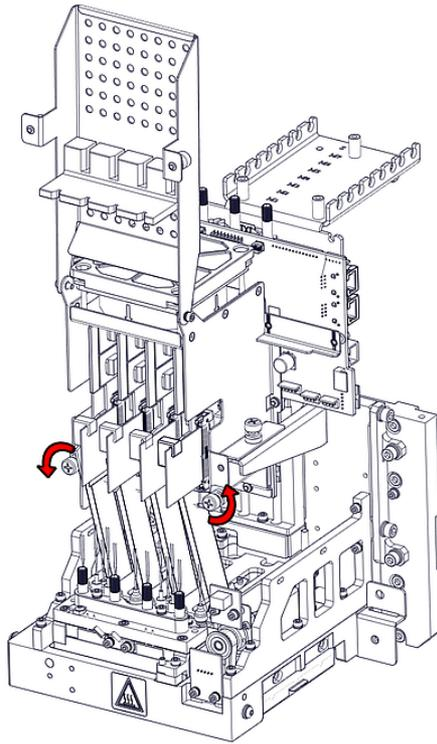

Figure 4-91 Loosening the driver-card bracket screws

12. Release the driver-card support.

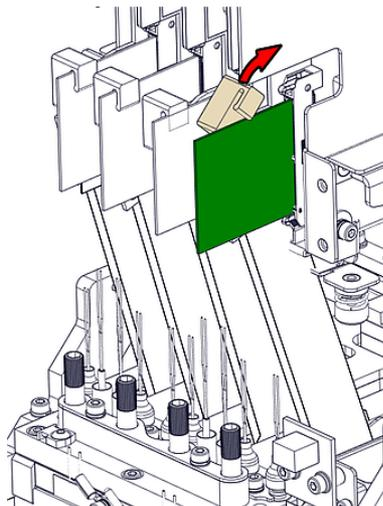

Figure 4-92 Releasing the driver-card support

13. Remove the driver card by releasing the latch at the points shown.

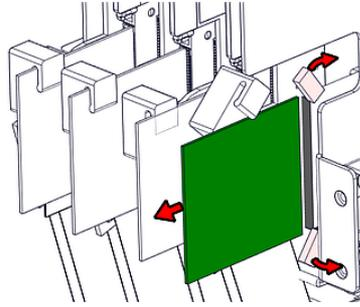

Figure 4-93 Releasing the driver-card latch

14. Release the upper and lower screws that secure the print head in the block.
(If necessary, you may use a 4-mm hex (Allen) key to loosen the screws.)

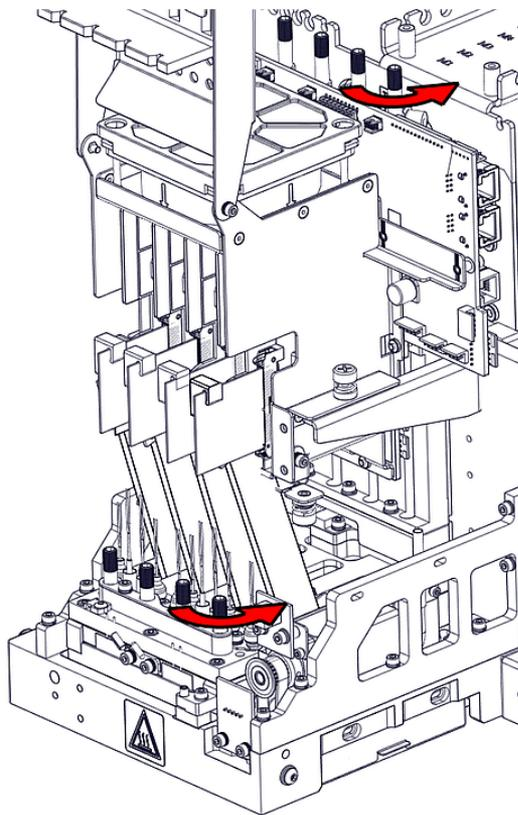

Figure 4-94 Releasing the print-head locking screws

15. Press down on the upper and lower locking screws to release the print head, and remove it from the bottom of the print block.

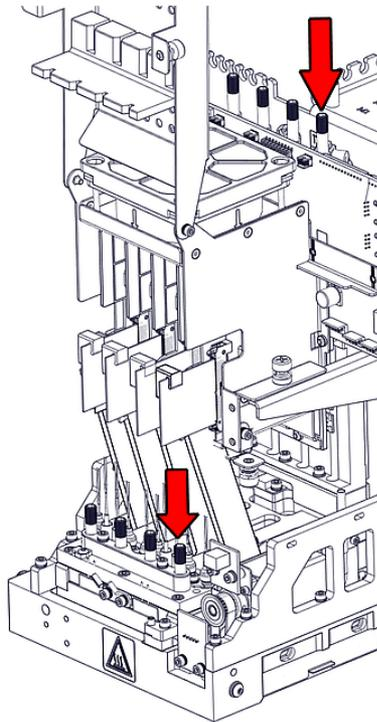

Figure 4-95 Releasing the print head

16. Make sure that along with the head, you remove the four (4) rubber O-ring seals.

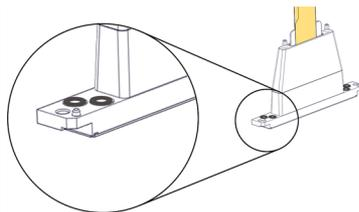

Figure 4-96 O-ring seals on the print head



Important

If the seals are not removed with the head, they are probably stuck to the print block housing. If so, remove them.

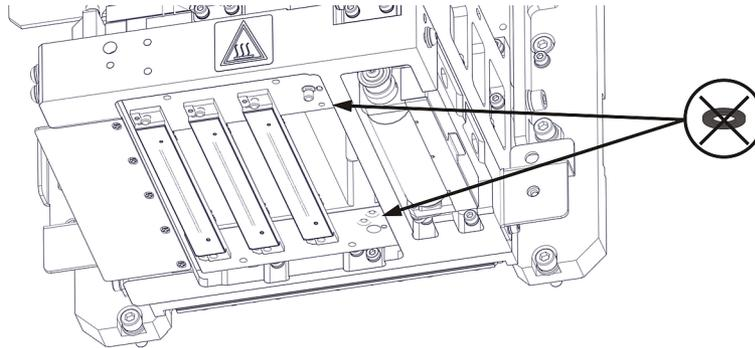

Figure 4-97 Making sure the O-rings are not stuck to the print block

Installing the New Head

17. Place four (4) O-ring seals in the replacement head (see Figure 4-96 on the previous page).
18. Position the head in the print block, making sure that the location pins are in place.

Note: Make sure to insert the head with the contacts on the driver card facing the print block.
19. Tighten the upper and lower screws that secure the print head in the print block (see Figure 4-95 on the previous page).

Note: Hand-tighten these screws. To avoid over-tightening, do *not* use a hex (Allen) key.
20. Insert the driver card into its socket, and secure the card.

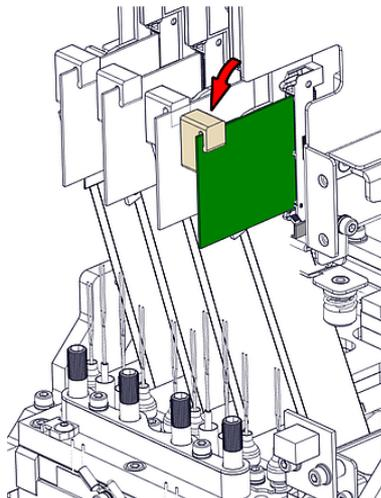

Figure 4-98 Securing the driver card

21. Lower the protective cover and tighten the screws to secure it.

22. In the *Replace print heads* screen, select the check box to confirm that you have replaced the head(s), and click **Next**.

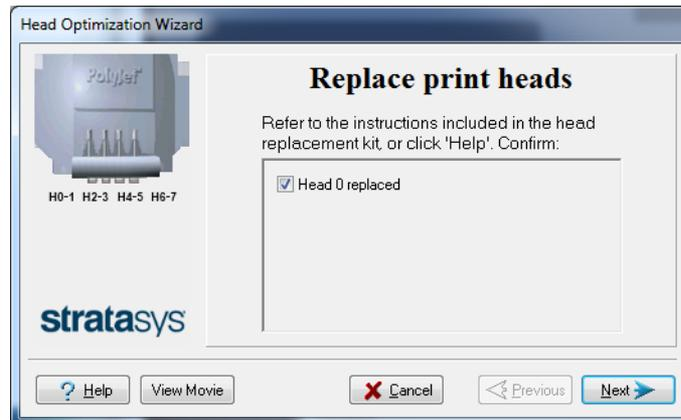

Figure 4-99 Head replacement confirmation

23. With your fingers, make sure that the new head is level and even with the other heads.



Figure 4-100 Checking the level of the new head

24. Confirm that the heads are level by selecting the check box in the following wizard screen, and click **Next**.

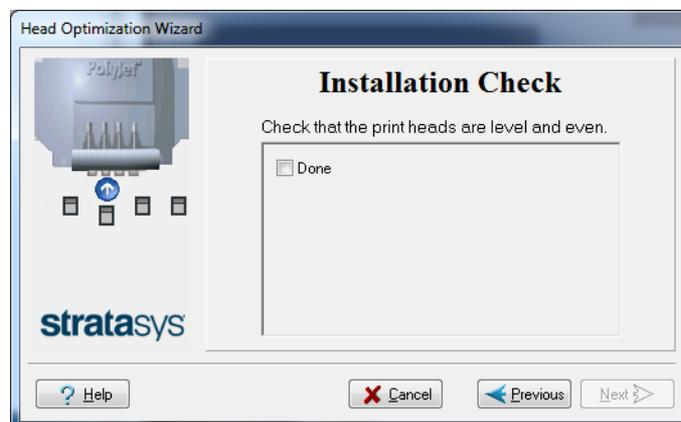

Figure 4-101 Installation-check screen

25. In the next wizard screen, confirm that you have removed all tools and objects from the printer.

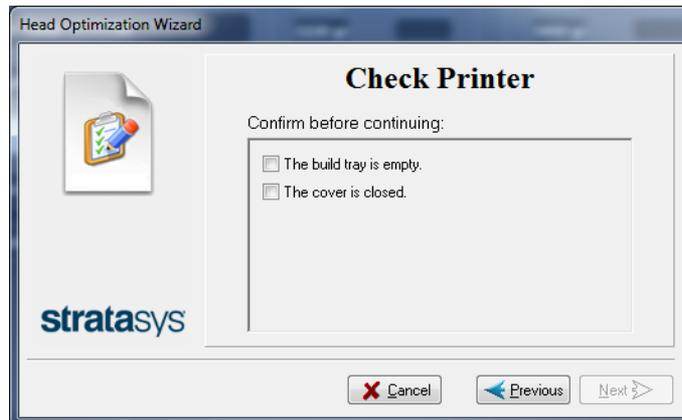

Figure 4-102 Cleared-tray confirmation screen

26. Close the printer cover.

The wizard continues by heating the heads, then filling and purging them.

If installation problems are detected, the wizard alerts you and instructs you how to continue (see "Installation Problems" below).

27. After replacing print heads, you should run the wizard again, to optimize the new heads, and to make sure that they are optimized for printing with the other heads. In the final wizard screen, select **Optimize all print heads** and click **Next**.

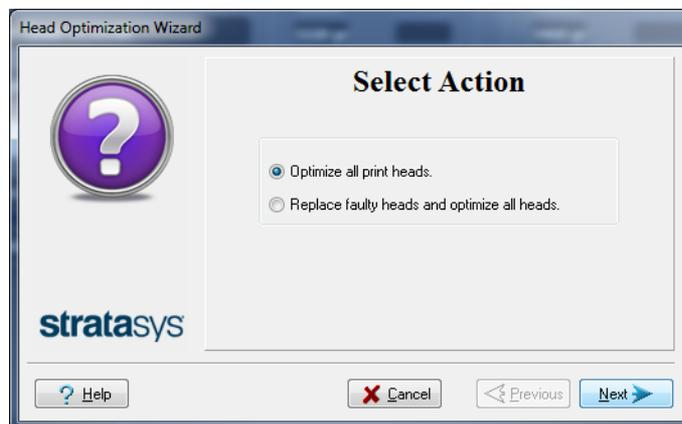

Figure 4-103 Final wizard Screen

Installation Problems

If the printer detects that there is a problem after you install print heads, a relevant warning screen appears.

- If the printer software does not detect the replaced head, release the print head card and re-insert it. (see "Removing the Defective Head" on page 4-66).

- If the replacement head was not calibrated by Stratasys, remove the head and replace it with another one.

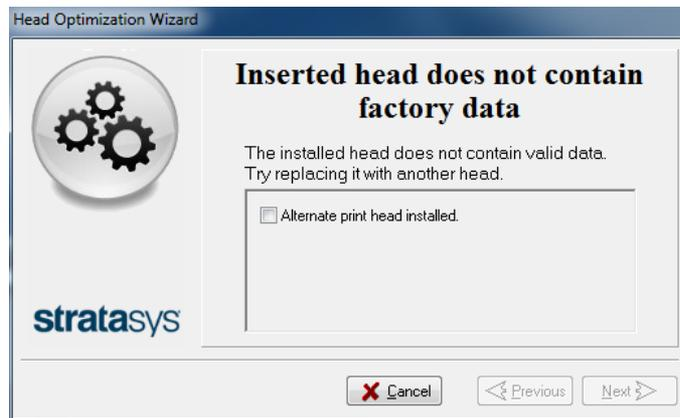

Figure 4-104 Invalid-head warning

Contact your Stratasys service provider about the uncalibrated head.

Testing and Calibrating the UV Lamps

The level of UV radiation from the lamps used for curing 3D prints can change over time. To ensure optimum curing of 3D prints during printing, a pop-up message reminds you to test the lamps and calibrate the level of UV radiation after every 300 hours of printing. You do this by running the UV Calibration Wizard.

To measure the UV radiation, you need:

- Stratasys TOL-03005-S (UV sensor and cable)
or—
- a stand-alone UV radiation meter, approved for use with the printer

The wizard compares the measured radiation to the recommended radiation level for each of the lamps, at each printing mode—High Speed / High Quality.

When calibrating the lamps, the wizard attempts to adjust the radiation level, if necessary.

- If the reading is within the acceptable range, the wizard continues to the next phase.
- If further adjustment is necessary, the current phase is repeated.
- If the level of UV radiation is too low to be properly adjusted, the wizard continues to the next phase, but the final wizard screen indicates that the lamp's radiation for the printing mode is unacceptable.



Before testing and calibrating the UV lamps:

- Make sure the glass lens on each of the UV lamps is clean. For easy access, run the Head Cleaning Wizard, and use the special sanding sponge supplied in the Start-Up Kit.
- Make sure that the glass over the UV radiation sensor is clean.

To test and calibrate UV lamp radiation:

1. Start the UV Calibration Wizard from the *Options* menu.
2. In the following screen, select **Calibrate UV Intensity** to adjust the lamp's radiation level to the acceptable range.

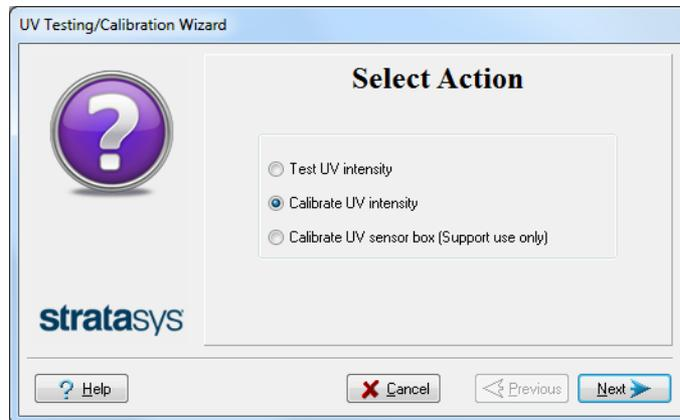

Figure 4-105 UV Test/Calibration selection

3. In the following screen, select the UV sensor and measuring device to be used.

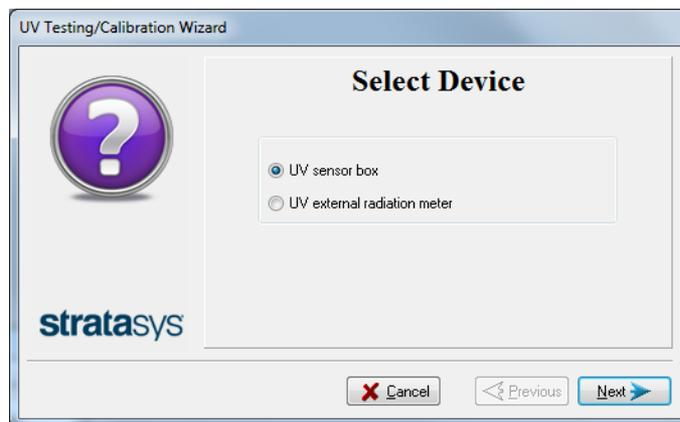

Figure 4-106 UV device selection

**UV Measuring Device**

When you use the Stratasys UV sensor box (TOL-03005-S), you connect it to the printer. The wizard automatically measures and calibrates the UV radiation.

If you use a stand-alone UV radiation meter, you need to manually enter the readings from the meter in the wizard screens.

4. Make sure that the build tray is empty. Confirm this in the wizard screen and click **Next**.

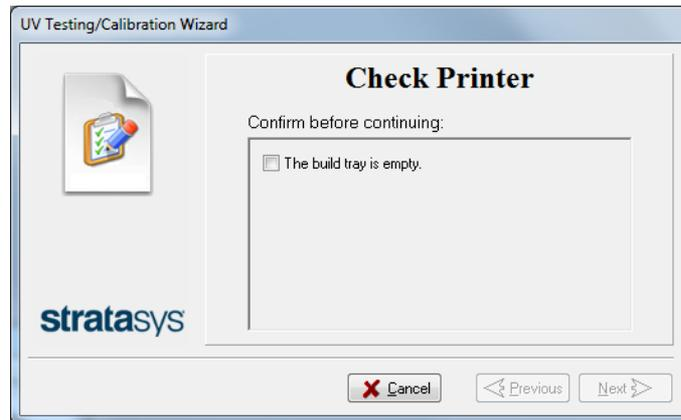

Figure 4-107 Printer preparation

- When using a Stratasys UV sensor box that you connect to the printer (TOL-03005-S), continue with "UV Sensor Connected to Printer" on the next page.
- When using a stand-alone UV radiation meter, continue with "External UV Meter" on page 4-78.

UV Sensor Connected to Printer

The following steps apply when using the Stratasys UV sensor box that you connect to the printer. They do not apply when using a UV external radiation measuring device.

1. To synchronize the wizard and the UV sensor, enter the CF number from the label on the back of the UV sensor box.

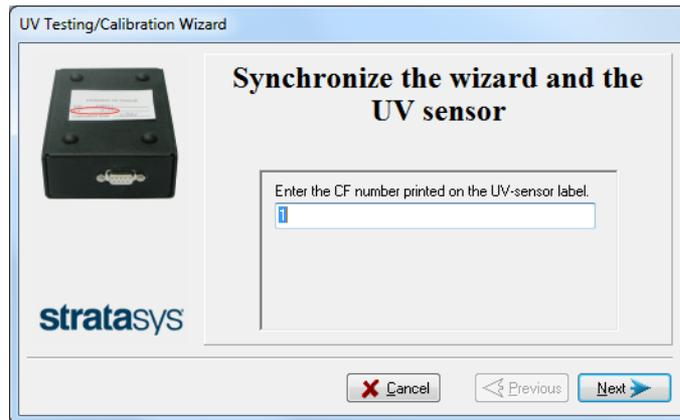

Figure 4-108 UV sensor synchronization



Figure 4-109 Label on the bottom of the UV sensor box

2. Click **Next**.

The build tray lowers so you can connect the UV sensor box.



Figure 4-110 UV sensor connector

3. Confirm the items listed in the wizard screen and click **Next**.

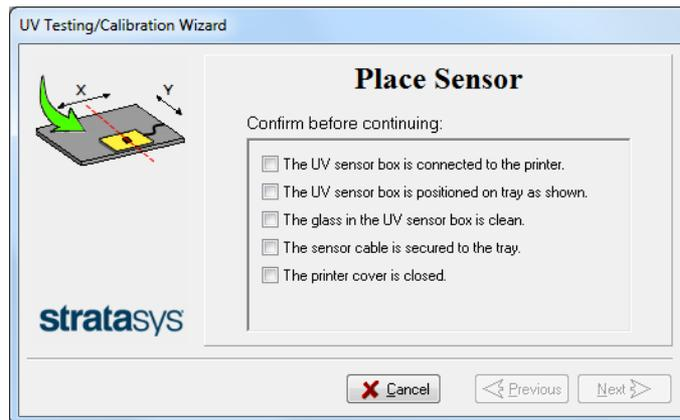

Figure 4-111 Sensor positioning

Continue with "UV Measurement " on page 4-80.

External UV Meter

The following steps apply when using a stand-alone UV meter. This section does **not** apply when using the Stratasys UV sensor box connected to the printer.

1. When the following screen appears, open the printer and place the UV sensor (probe) at the rear edge of the tray, in the center.

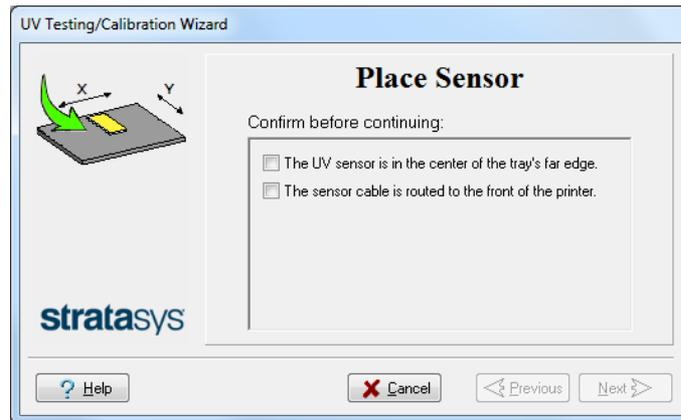

Figure 4-112 Sensor placement screen

2. Lead the cable out of the printer so that you can close the printer, and tape it down to make sure that it does not interfere with the moving print block.

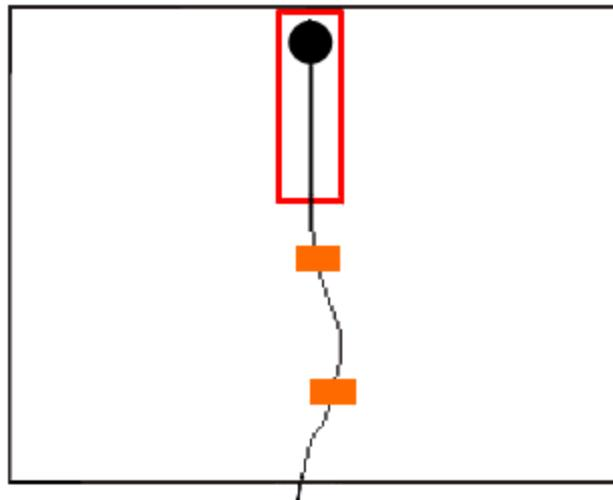

Figure 4-113 Correct UV-sensor placement

3. Close the printer, while checking that the sensor does not move out of position.
4. Set the UV meter to measure mJ/cm².
5. Set the range on the meter to 2,000.

6. Connect the cable from the sensor to the UV meter.
7. Turn on the UV meter, and wait until "0 0 0.0" appears on the display.
8. In the wizard screen, confirm that the sensor is positioned correctly, and click **Next**.

Continue with "UV Measurement " on the next page.

UV Measurement

The UV lamps power up and stabilize. (This takes several minutes.) Then, the print block passes over the sensor and the wizard compares the measured radiation to the recommended level for each UV lamp and printing mode. During this process, which takes 20–40 minutes, you need to monitor the progress as displayed in the wizard screen.

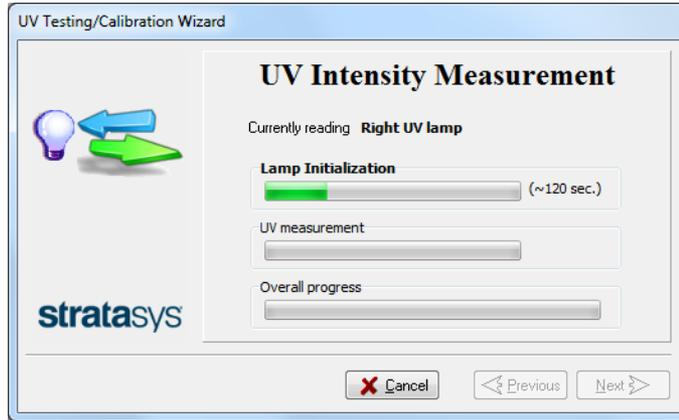

Figure 4-114 UV measurement progress

When using a stand-alone radiation meter (not the Stratasys UV sensor box connected to the printer): Reset the meter and enter the reading (measurement) when you are prompted to do so.

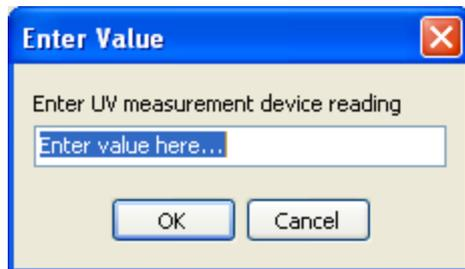

Figure 4-115 UV Measurement dialog box

If the UV level measured is not acceptable, the wizard calibrates the UV lamp by adjusting the current supplied to it, and then tests it again.

When all UV tests have finished, the results are displayed, showing the condition of the lamps after calibration (see Figure 4-116 below).

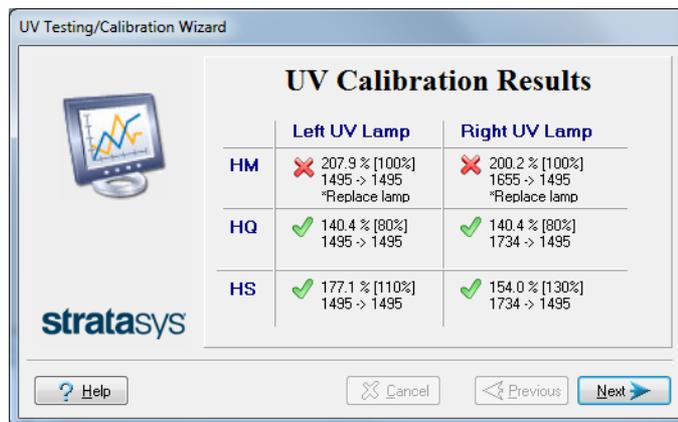

Figure 4-116 Results and condition of UV lamps after calibration

After examining the UV calibration results:

1. Click **Next**.
2. Remove the UV sensor and close the printer cover. After confirming the items listed in the wizard screen, click **Next**.

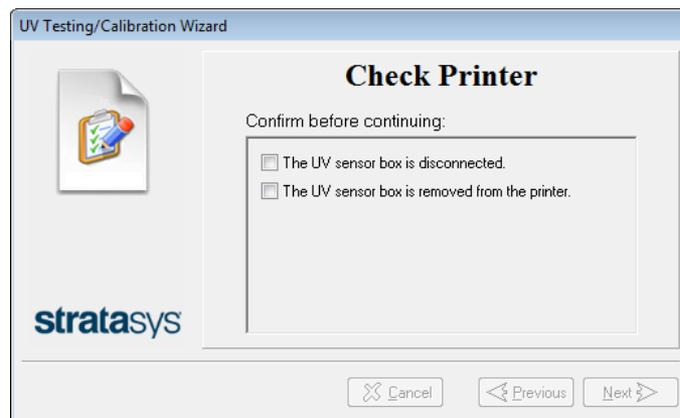

Figure 4-117 UV sensor removal

If the results are not acceptable for quality printing, this is indicated in the final wizard screen.

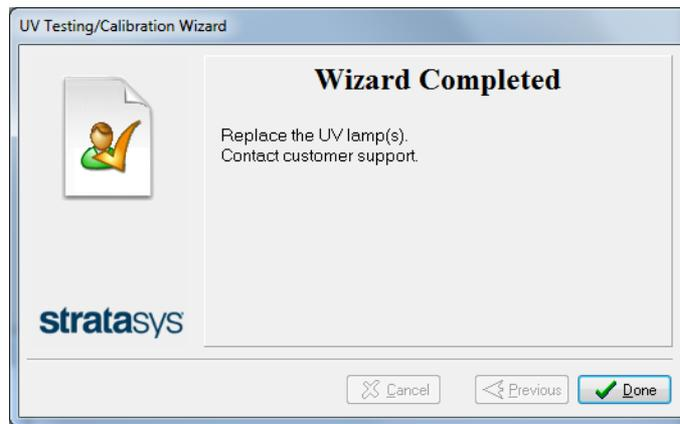

Figure 4-118 Final UV Calibration Wizard screen

Calibrating the Load Cells

Load cells are sensors that measure the weight of the material cartridges and the waste container in the printer. It is important that you periodically check that the weight measurements are accurate to prevent unnecessary waste of printing materials or printer malfunctions.

To calibrate load cells:

1. Start the Load Cell Calibration wizard from the *Options* menu.
2. In the following screen, select one or more load cells that you want to calibrate.

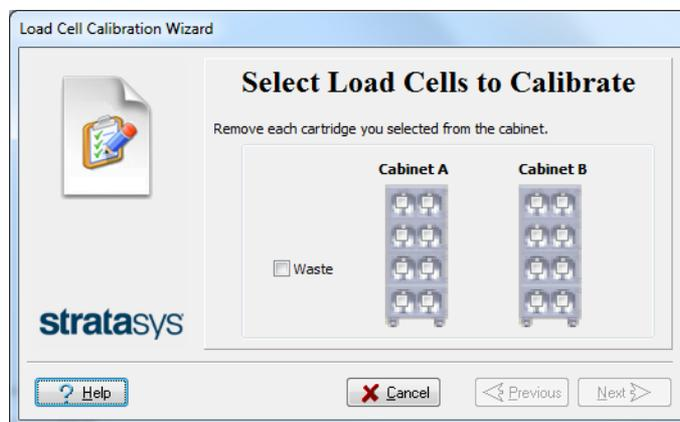

Figure 4-119 Load cell selection

3. Remove each selected cartridge from the materials cart, and click **Next**.
4. In the next wizard screen, observe the numbers and wait until the weight level is relatively stable—two units above or below the average level shown.

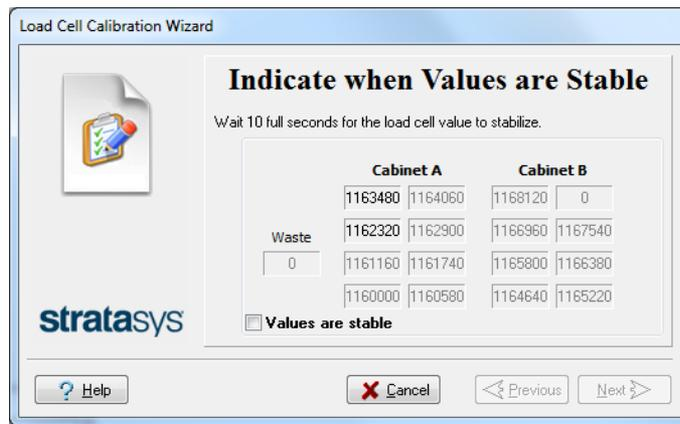

Figure 4-120 Weight stabilization

5. Select the check box, and click **Next**.
6. Click **Done** in the final wizard screen.



Flushing the Print-Block Heater

If the printer is configured to print in High Speed mode, with three model materials, the print-block heater needs to be periodically flushed. This is necessary to prevent possible clogging of unused material channels in this mode. A reminder message appears if 250 printing hours have passed since the print-block heater was last flushed.



The time required for completing this procedure depends on the materials loaded in the printer. A time estimation appears in the wizard before starting the flushing process.

To flush the Print-block Heater:

1. From the *Options* menu, open the Material Replacement wizard.

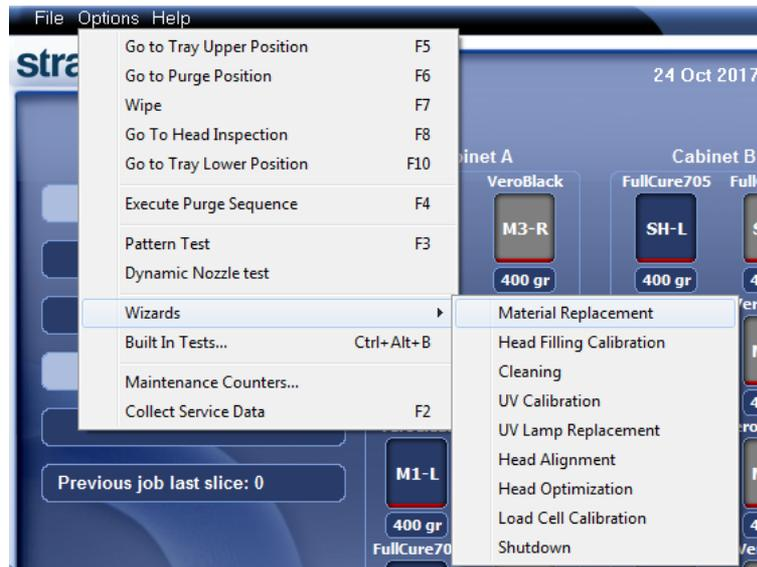

Figure 4-121 Opening the Material Replacement wizard

2. In the opening screen, click **Next**.
3. In the *Material Replacement Options* screen, click **Advanced Settings**.

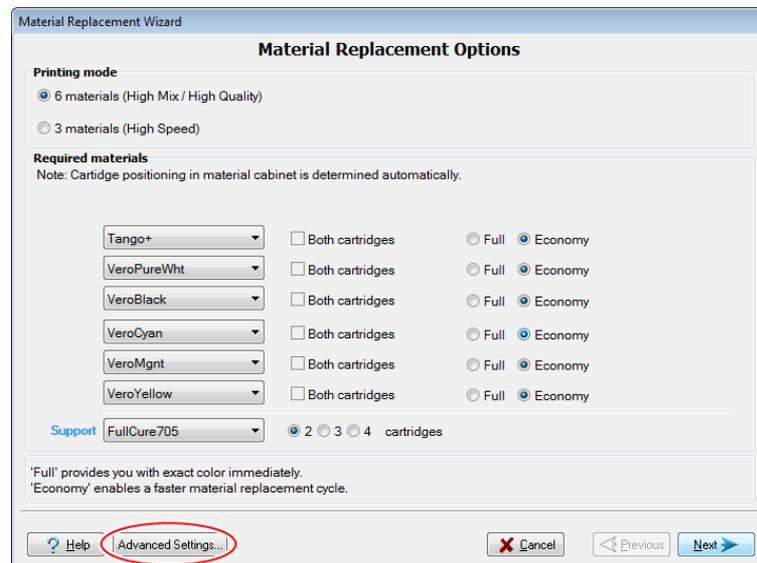

Figure 4-122 Material Replacement Options screen

4. In the *Advanced Settings* screen, select **Manual slot selection** and click **Apply**.



Figure 4-123 Manual slot selection

5. When the *Material Replacement Options* screen opens again, select the following:

- 6 materials**
- Economy**

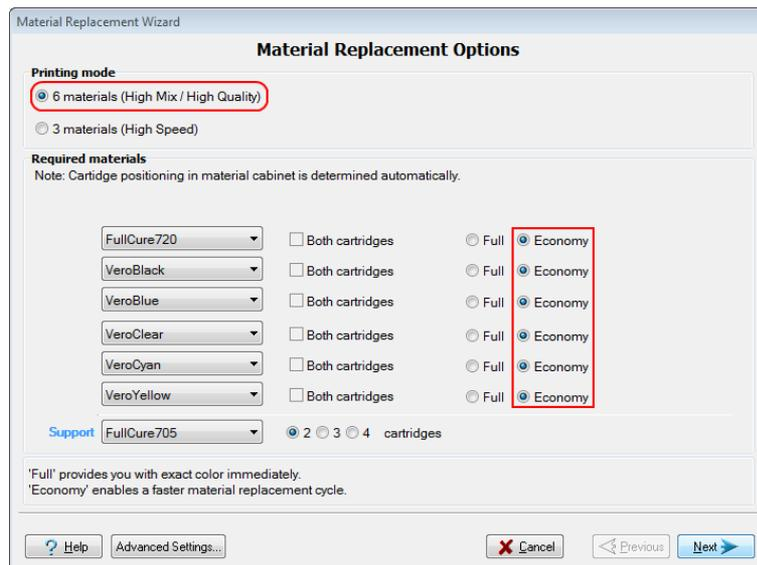
Figure 4-124 Selections in the *Material Replacement Options* screen

Make sure that the printer is loaded with the selected materials. This procedure requires six model materials to flush all of the channels in the print-block heater.

6. Click **Next**.

- In the *Cartridge Positioning* screen, make sure that the material cartridges are properly positioned.

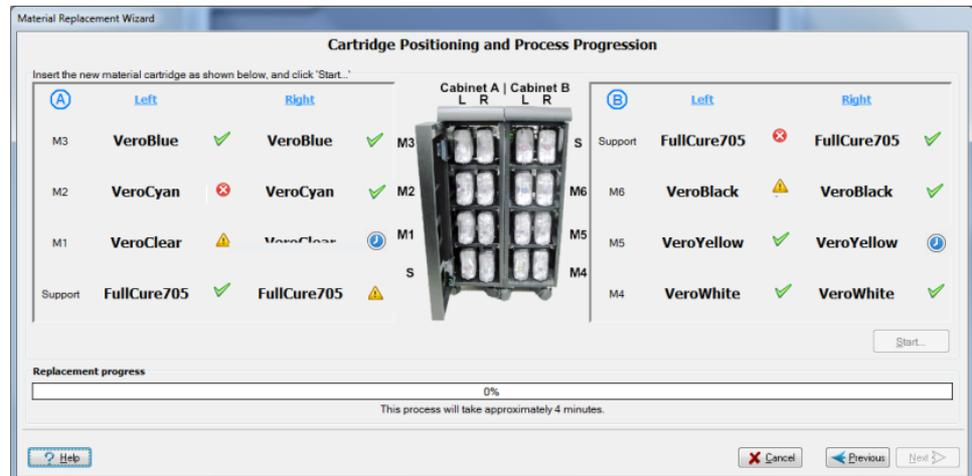

Figure 4-125 Cartridge Positioning screen

Symbols:

- ✓ The correct cartridge is in this slot.
- ✗ No cartridge (or the incorrect cartridge) is in this slot.
- ⚠ The cartridge in this slot has insufficient weight to complete the material replacement process.
- ⌚ The expiration date of the cartridge in this slot has passed.

Note: The time needed to complete this process depends on the materials currently loaded in the printer. The estimated time is displayed at the bottom of the *Cartridge positioning* screen.

- Click **Start**.
- Read the warning message, and click **OK**.
The wizard drains the model materials from the print block and fills it with the selected materials.
When the process is finished, the *Wizard Completed* screen appears.

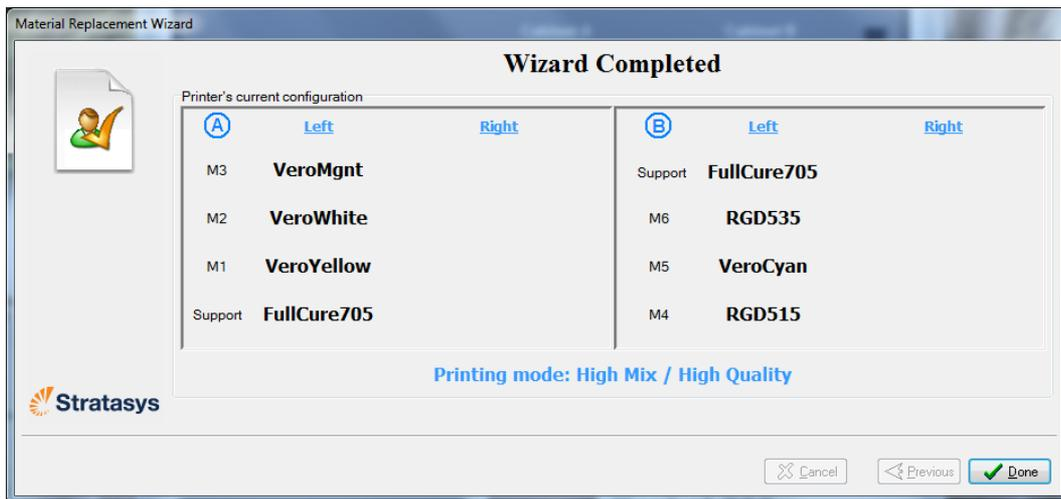

Figure 4-126 Wizard Completed screen

10. Click **Done**.

The printer-control application restarts, and it is now in High Mix / High Quality mode, using all six material loaded in the printer.

Returning to the previous mode

To return to the High Speed printing mode:

1. Run the Material Replacement wizard again.
2. In the *Material Replacement Options* screen, select the following:
 - 3 materials (High Speed)**
 - Economy**

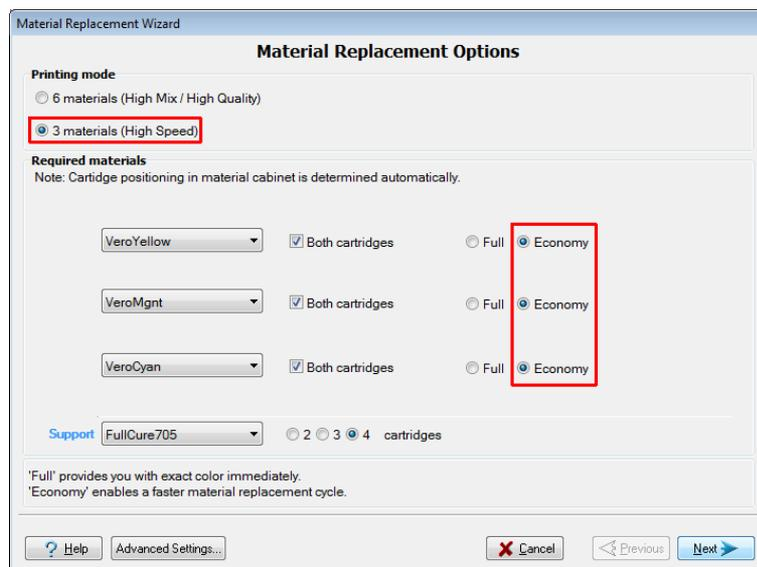

Figure 4-127 Material Replacement Options selection

3. Click **Next**.

4. In the *Cartridge positioning* screen, make sure that the material cartridges are properly positioned.

Note: The time needed to complete this process depends on the materials currently loaded in the printer. The estimated time is displayed at the bottom of the *Cartridge positioning* screen.

5. Click **Start**.
The wizard fills both channels of each print head with the selected material.
6. When the *Wizard Completed* screen appears, click **Done**.
After the printer-control application restarts, you can print.

Replacing the Waste-Pump Tubes

The tubes that pump waste material from the roller waste collector and the purge unit should be replaced after 1000 hours of use. After this time, the printer software sends a maintenance alert to display on the printer interface screen.

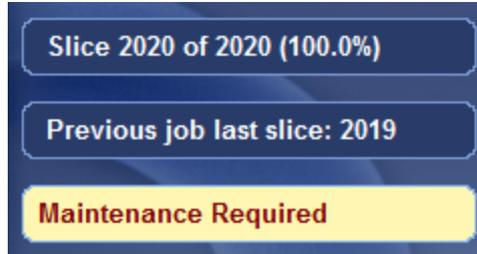

Figure 4-128 Maintenance alert

You can check when the pump tubes need to be replaced in the Maintenance Counters interface.

To open the *Maintenance Counters* interface:

- Click on the "Maintenance Required" indicator.
- or—
- From the *Options* menu, select **Maintenance Counters**.

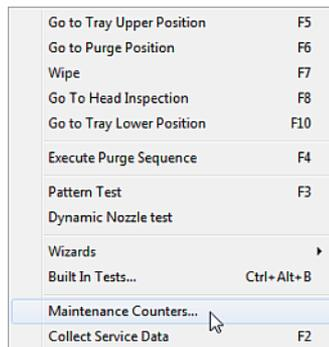

Figure 4-129 Selecting *Maintenance Counters* from the *Options* menu.

When the *Maintenance Counters* screen opens, scroll down to the *General Pumps* section.

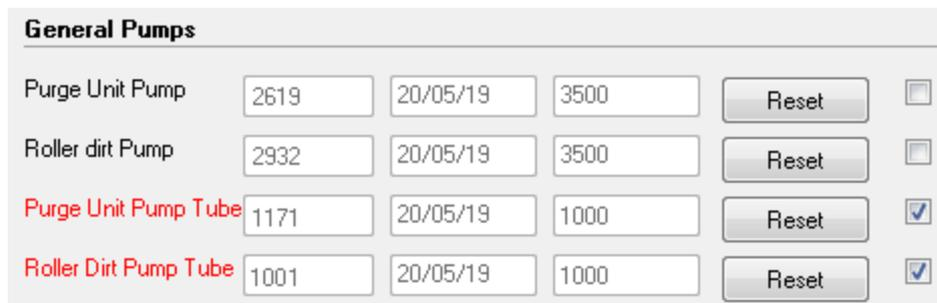

Figure 4-130 Pump Maintenance Counters

The waste-pump tubes that require replacing are displayed in red.

Note: If the check box on the right is selected, the "Maintenance Required" indicator appears when that task is due.

To replace pump tubes, you replace the entire pump "cassette" in the printer. Replacement cassettes are supplied in the printer Start-up Kit. Additional cassettes can be ordered from your Stratasys service provider.

To replace the waste pump tubes:

1. Prepare—
 - disposable cleaning gloves
 - protective eye wear
 - a supplied cleaning cloth or equivalent (for cleaning the material that spills while replacing the tubes)
 - disposable cup (for catching material from the tubes when the fittings are disconnected)
2. Make sure that the printer is in Idle mode (see the figure on page 4-4).

Note: The printer enters Idle mode about 16 minutes after printing stops. To force the printer into Idle mode, close the printer application: From the *File* menu, click **Exit**.
3. Using an 8-mm hex (Allen) key, open the two latches that secure the left printer panel (as you face the printer).



Figure 4-131 Opening a panel latch

4. Open the panel and disconnect the ground (earth) wire.

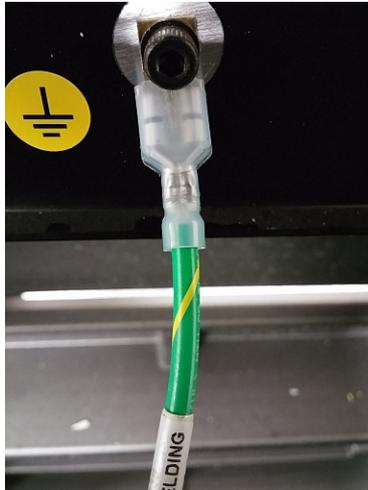

Figure 4-132 Ground wire connected to panel

5. Remove the panel.
6. Identify the waste pump that requires tube replacement.

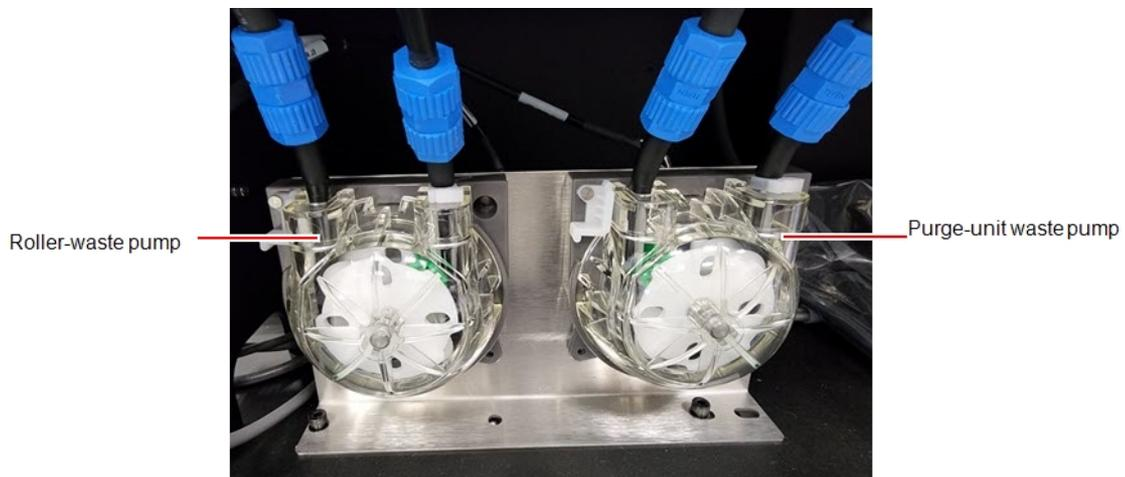

Figure 4-133 Waste pumps (sample)

7. Put on protective gloves and eye wear.



Caution

Uncured printing material might cause skin and eye irritation. Use disposable cleaning gloves to protect your hands and protective eye wear to protect your eyes.

8. Disconnect the fittings:
 - a. Unscrew the fittings that connect each waste-pump tube.
 - b. Separate the tubes and put them into the disposable cup to catch material that spills.

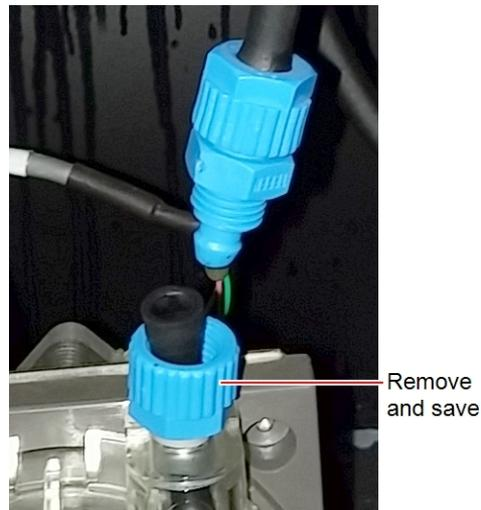

Figure 4-134 Disconnecting pump tubes

9. Remove the part of the fitting remaining on the pump tube, and save it.
10. Rotate the white restraining clip to release the pump.

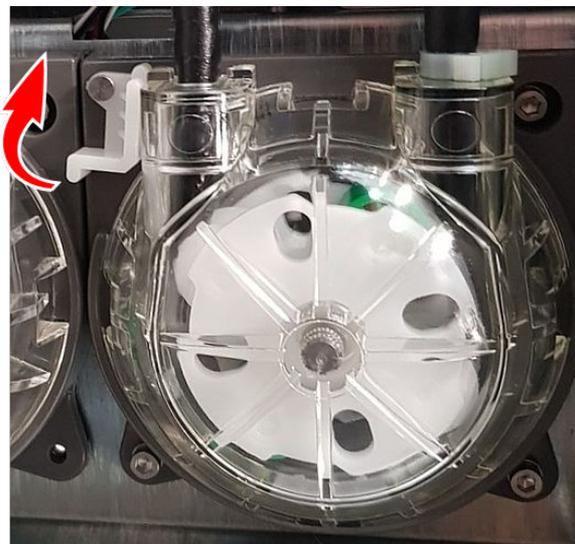

Figure 4-135 Releasing the pump (sample)

11. When the tubes on both sides of the pump are disconnected, rotate the pump "cassette" counter-clockwise and remove it.

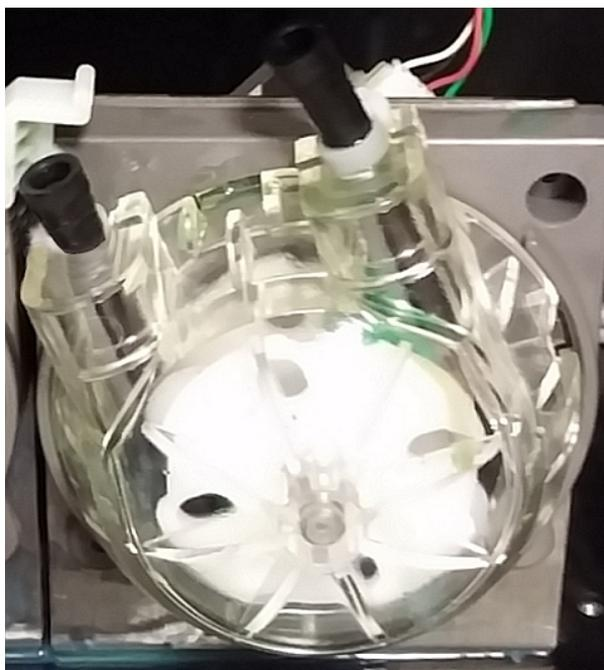

Figure 4-136 Rotating the pump cassette (sample)

12. Holding a new pump cassette with one hand, rotate the rotor.
This ensures that the pump functions properly after a long storage period.

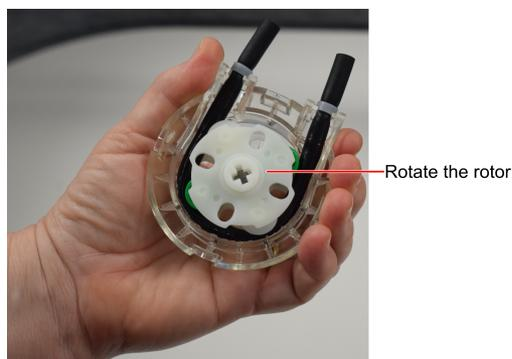

Figure 4-137 Preparing the pump cassette for installation

13. Attach the new pump cassette to the printer.

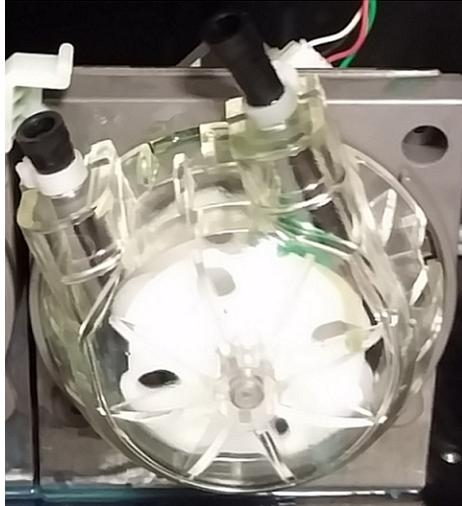

Figure 4-138 Attach the pump cassette (sample)

Fit the cassette into the slots in the housing, and turn clockwise to working position.

14. Rotate the white restraining clip to secure the pump.

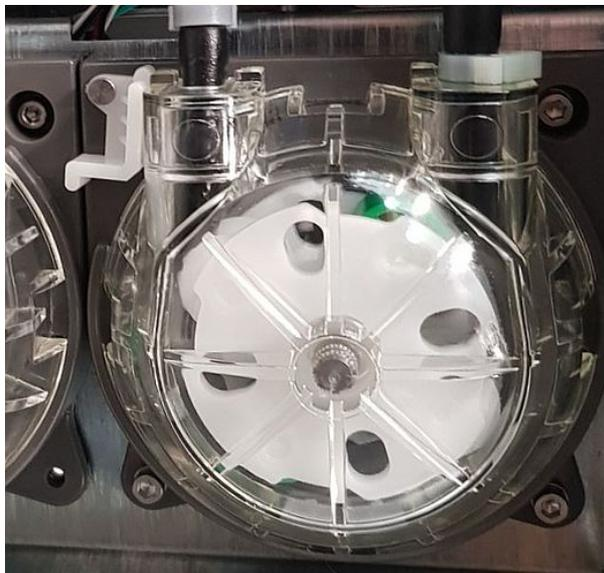

Figure 4-139 Securing the pump (sample)

15. Remove the clamp from the tube that is directed to the waste container (pump outlet).

Clamp removed from outlet side

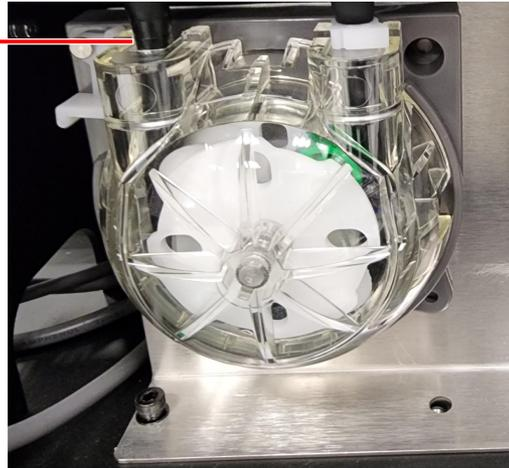

Figure 4-140 Clamp removed from the outlet side of the pump (sample)

16. Connect the tubes to the new pump cassette.

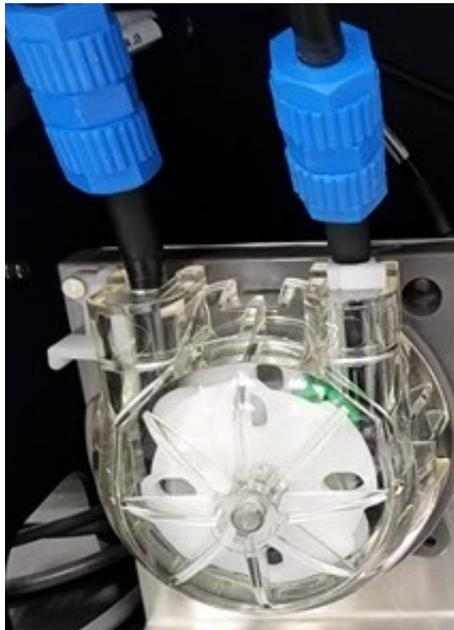

Figure 4-141 Secured pump (sample)

17. Use the cleaning cloth to wipe the spilled material.
18. Perform the Pattern Test and make sure the pump cassette operates properly. See "Pattern Test" on page 4-34.
19. If necessary, replace the pump cassette on the other waste pump.
20. Attach the panel to the printer.
Make sure to reconnect the ground wire to the printer panel.
21. Open the *Maintenance Counters* screen, scroll down to the *General Pumps* section, and click **Reset** for the relevant counter(s) (see Figure 4-130 on page 4-89).

Replacing the Material Filters

Filters are installed in the lines that supply model material to the print heads. There are two configurations:

- In the old configuration, the material filter includes several luer fittings.
- In the new configuration, the material filter is connected directly and secured by only 2 tie wraps.

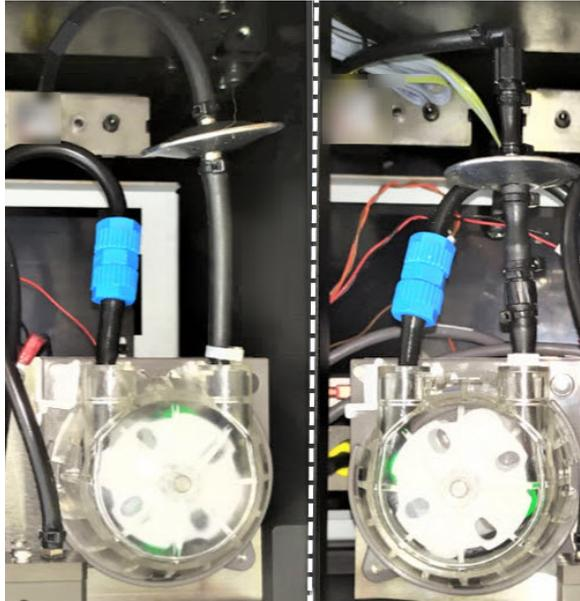

Figure 4-142 Material filters – new configuration (left); old configuration (right)



In the next service visit, the old configuration will be replaced by the new configuration. The new configuration prevents drips and reduces the number of connections significantly.

To replace the material filter:

1. Prepare the following tools and materials:
 - 8-mm hex (Allen) key
 - protective gloves
 - cleaning cloths or paper towels
 - replacement 10-micron filters (supplied in the Start-up Kit)
 - tie-wrap cutters
2. Close the printer application.
3. Shut down the printer computer, and turn off the main power switch.
4. Using an 8-mm hex (Allen) key, open the latches that secure the back of the materials cabinet and remove the back of the cabinet.

- Put on protective gloves.

**Warning: Toxic and Corrosive Materials**

Prolonged contact with resins could cause skin irritation. Put on protective gloves before continuing.

- Disconnect the material filter starting with the top side.
 - For the old configuration, remove the tubing assembly.
Make sure that the fitting at the end of the feed-tube remains attached to the tube. Re-attach it, if necessary.
 - For the new configuration, use the cutters to cut the tie wraps on both sides.



tie wraps

Figure 4-143 Material filters tie wraps



Cover the filter with a cleaning cloth (or paper towels) to absorb material spillage.

- Attach the new filter to the disconnected tubes.
 - For the old configuration, connect the filter with the tubing assembly.
Hold the fitting at the end of the feed tube in place and turn the filter. Otherwise, the tube will be twisted and material might leak.
 - For the new configuration, attach the filter with the tie wraps on both sides.
- Discard the old filter.

**Caution:**

The filter contains uncured printing material. Discard the filter in accordance with applicable environmental regulations.

- Replace the back of the materials cabinet.

10. In the *Maintenance Counters* screen, click **Reset** and then **Close**.

Item	Total	Dated	Warning Time	User Warning
Total Printing time	0	18/04/22	N/A	
Model 1 Left Filter	0	18/04/22	300	Reset <input checked="" type="checkbox"/>
Model 1 Right Filter	0	18/04/22	300	Reset <input checked="" type="checkbox"/>
Model 2 Left Filter	0	18/04/22	300	Reset <input checked="" type="checkbox"/>
Model 2 Right Filter	0	18/04/22	300	Reset <input checked="" type="checkbox"/>
Model 3 Left Filter	0	18/04/22	300	Reset <input checked="" type="checkbox"/>
Model 3 Right Filter	0	18/04/22	300	Reset <input checked="" type="checkbox"/>
Model 4 Left Filter	0	18/04/22	300	Reset <input checked="" type="checkbox"/>
Model 4 Right Filter	0	18/04/22	300	Reset <input checked="" type="checkbox"/>
Model 5 Left Filter	0	18/04/22	300	Reset <input checked="" type="checkbox"/>
Model 5 Right Filter	0	18/04/22	300	Reset <input checked="" type="checkbox"/>
Model 6 Left Filter	0	18/04/22	300	Reset <input checked="" type="checkbox"/>
Model 6 Right Filter	0	18/04/22	300	Reset <input checked="" type="checkbox"/>
Model 7 Left Filter	0	18/04/22	300	Reset <input checked="" type="checkbox"/>
Model 7 Right Filter	0	18/04/22	300	Reset <input checked="" type="checkbox"/>
Support 1 L Filter	0	18/04/22	300	Reset <input checked="" type="checkbox"/>

Figure 4-144 Maintenance Counters screen, showing material filters (sample)

For more information about maintenance counters, see "Maintenance Counters" on page 4-32.

Replacing the Odor Filter

If the printer exhaust is not connected to an external ventilation system, a built-in activated-carbon filter removes odors from printing materials. This filter should be replaced regularly (as necessary) to keep your working environment pleasant. This is normally done during the preventive-maintenance service visit.



If the printer exhaust is connected to an external ventilation system, the odor filter is not needed and should be removed from the printer. Odor filter removal improves heat expulsion and system cooling.

Replacing the UV Lamps

The UV lamps used for curing 3D prints have a long, but limited, working life. You can test and adjust their effective power with the UV Calibration wizard (see "Testing and Calibrating the UV Lamps" on page 4-73). If you need to replace a UV lamp bulb or UV reflector, follow these instructions:

To replace the UV lamp bulb or UV reflector:

1. Make sure the printer is in *offline* mode.



Figure 4-145 Offline mode indicator (red)

The *online/offline* button at the bottom of the printer interface should be red. If not, click it to switch the printer to *offline* mode.



Warning

Before continuing, make sure that the safety interlock is not defeated, and that the UV lamp is not hot.

2. Start the UV Lamp Replacement wizard from the *Options* menu.

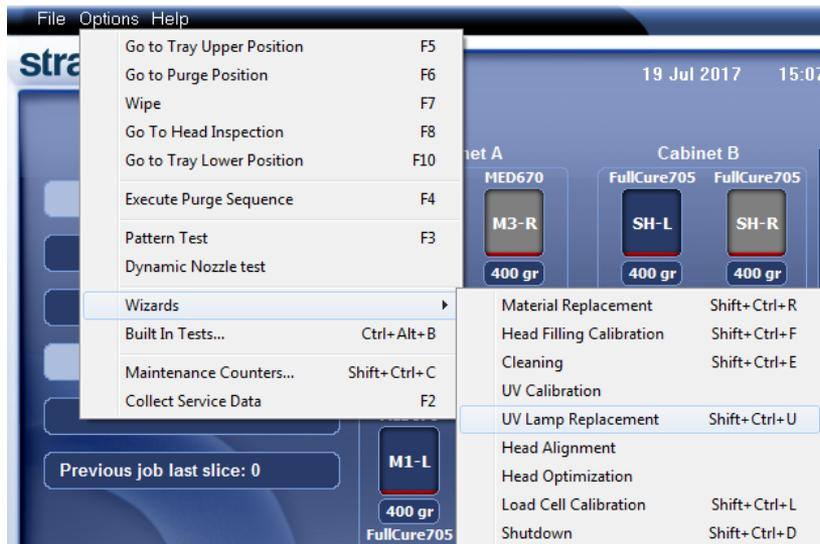

Figure 4-146 Selecting the UV Lamp Replacement wizard

3. Make sure that the build tray is empty, and confirm this in the wizard screen. Then, close the printer, and click **Next**.

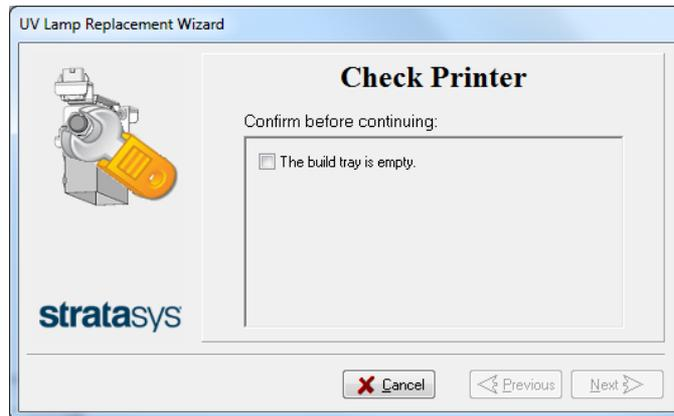

Figure 4-147 Tray confirmation

The axes move to the “home” position.

4. Select the UV lamp(s) to be replaced and click **Next**.



Figure 4-148 UV lamp selection screen

5. Disconnect the UV-lamp power connector and the UV heat fuse connector.

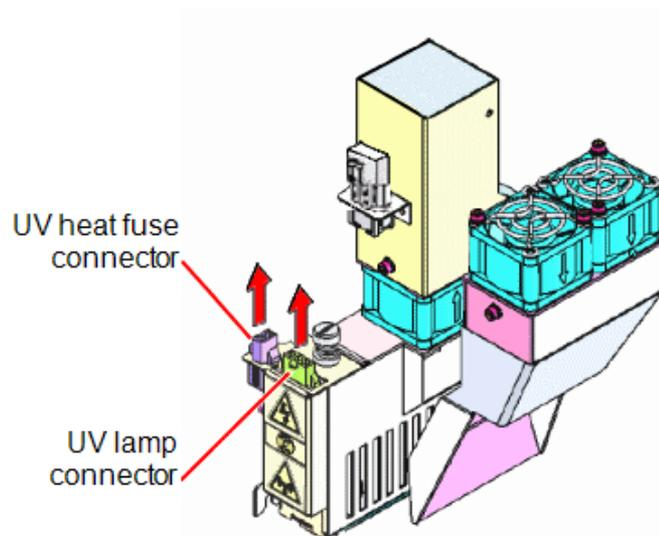

Figure 4-149 Disconnecting the UV lamp

Note: Do *not* disconnect the power connection to the cooling fans.

6. Loosen the screw securing the UV lamp cover (A), and pull the cover up (B), then out (C).

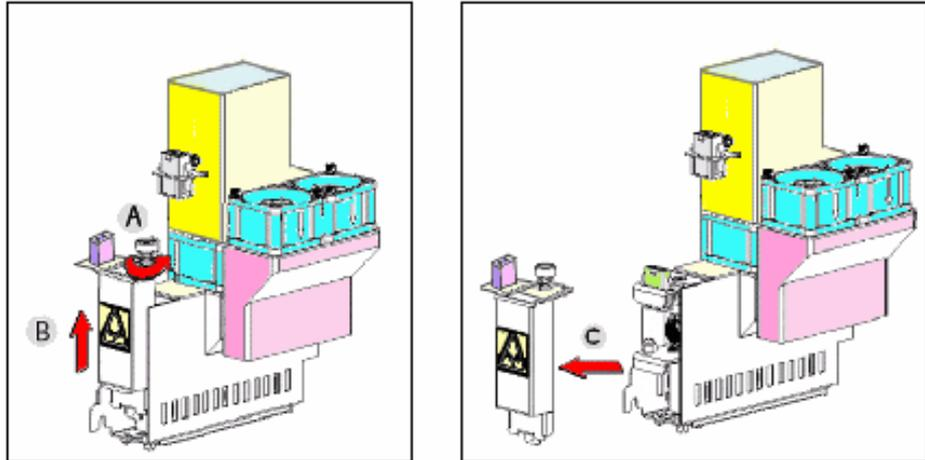

Figure 4-150 Removing the UV lamp cover

7. Pull the UV reflector out of the UV housing.

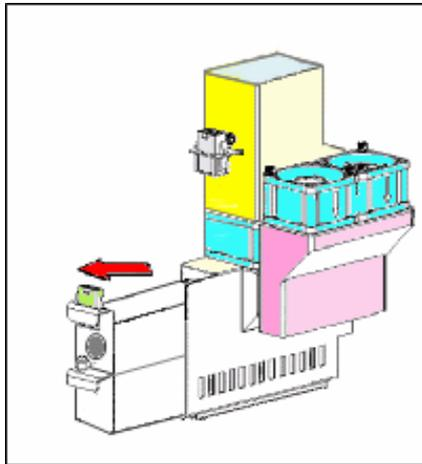

Figure 4-151 Removing the UV lamp reflector

8. Using a 2.5-mm hex key, remove the UV lamp clamp (2 screws).

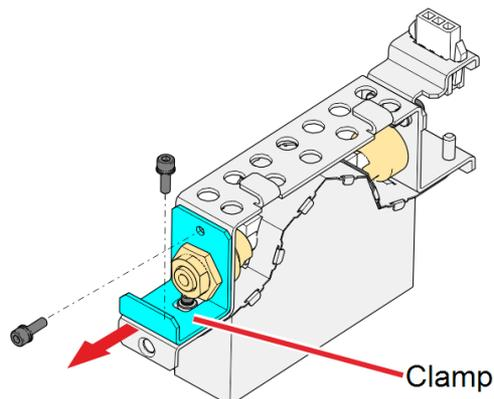

Figure 4-152 Removing the UV lamp clamp

9. Remove the UV lamp bulb from the UV reflector.

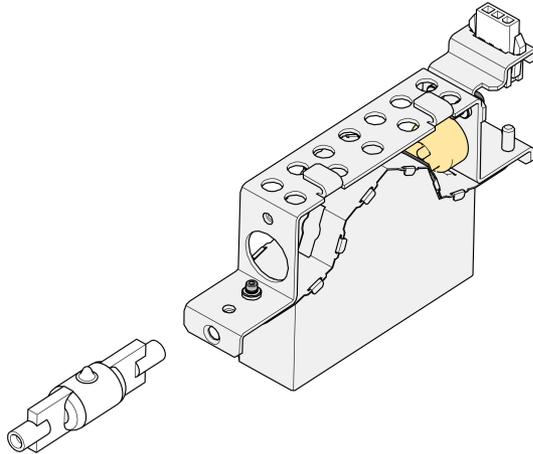

Figure 4-153 Removing the UV lamp bulb

10. Before continuing, inspect the spring-loaded pins. If there are burn marks around the pins or if the pins are loose—their springs are not functioning properly—and do not support the bulb, continue with step 15, to replace the UV reflector. Otherwise, continue with step 11 to replace the UV lamp bulb.

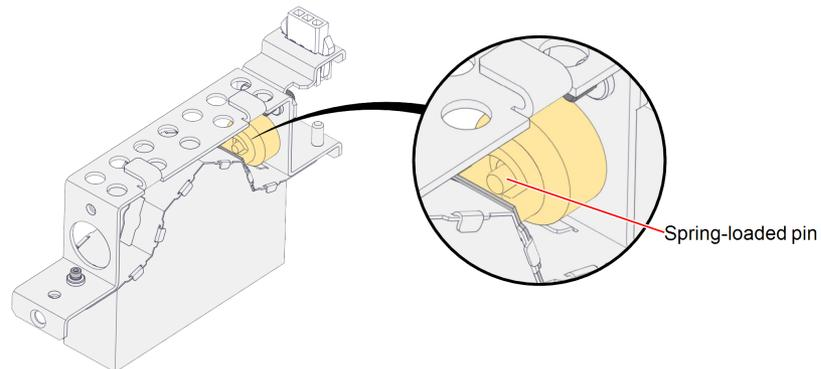

Figure 4-154 Spring-loaded pin

- Using the polyurethane tube provided in the kit, push the new UV lamp bulb into the UV reflector. Make sure that the tip on the bulb is facing the direction of the top of the reflector.

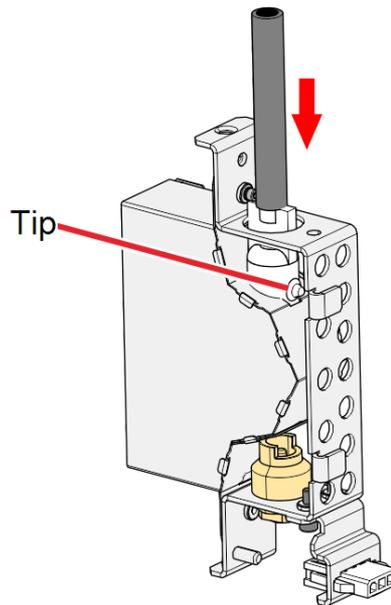

Figure 4-155 Pushing the new UV bulb into the UV reflector

- Twist the tube by 180° (a), and continue to insert the UV lamp bulb into the UV reflector (b). Make sure that the tip on the bulb is facing the direction of the opening of the reflector.

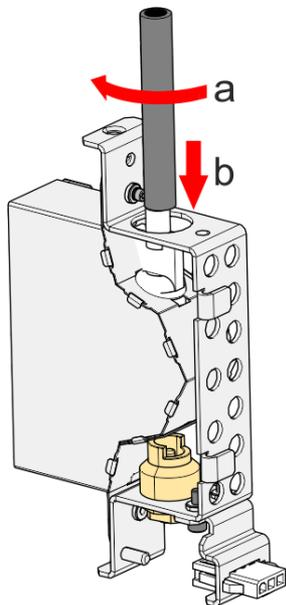

Figure 4-156 Twisting the tube and inserting the UV lamp bulb

13. Use the UV lamp clamp to insert the lamp bulb into place in the UV reflector.

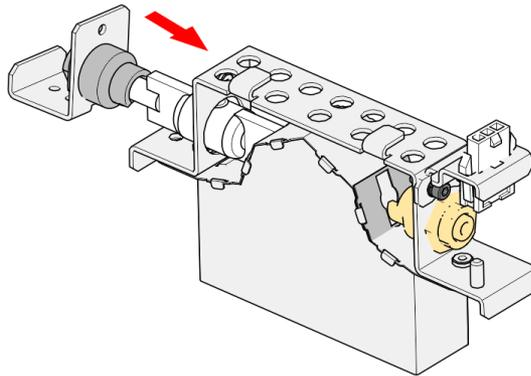

Figure 4-157 Pushing the UV lamp bulb into place

14. Using a 2.5-mm hex key, secure the clamp to the UV reflector, and continue with step 17 .

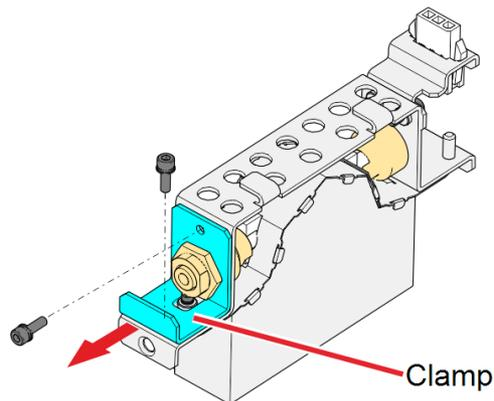

Figure 4-158 Attaching the UV lamp clamp

15. Inspect the new UV reflector, and make sure that a black strip is attached to the inside of it. If not, install one—on the side of the reflector *opposite* (not next to) the print block.

Note: Extra black strips are included in the printer Start-Up Kit. If necessary, you can remove the black strip from the old reflector and install it in the new reflector (as long as the black paint has not faded).

16. Discard the old UV reflector and lamp.



Dispose of the used UV lamp in accordance with environmental and safety requirements.



Warning: Broken UV lamp hazard

UV lamps contain mercury. Deal with broken lamps with caution.

- Ventilate the room thoroughly.
- Use protective gloves when collecting mercury and lamp components.
- Remove spilled mercury with a method that prevents the generation of mercury vapor, such as a syringe, packing tape or paper.
- Place the broken lamp, mercury and contaminated materials in an air-tight, non-metallic container.

17. Insert the UV reflector unit into the housing, next to the print block.

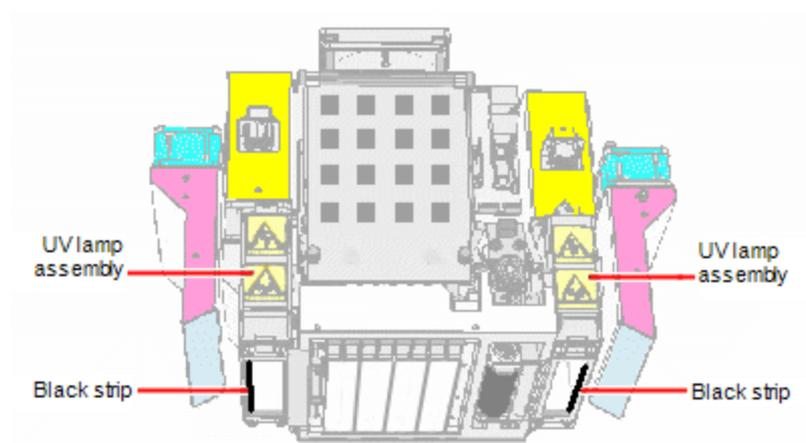

Figure 4-159 Print block and UV lamp assembly, showing correct placement of black strip

18. Replace the UV lamp cover by inserting it into the slot on the bottom of the housing, and tighten the securing screw on top.

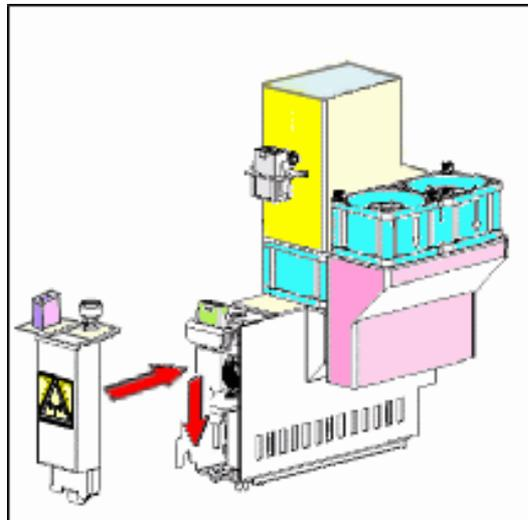

Figure 4-160 Replacing the UV lamp cover

19. Reconnect the power and heat fuse connectors.

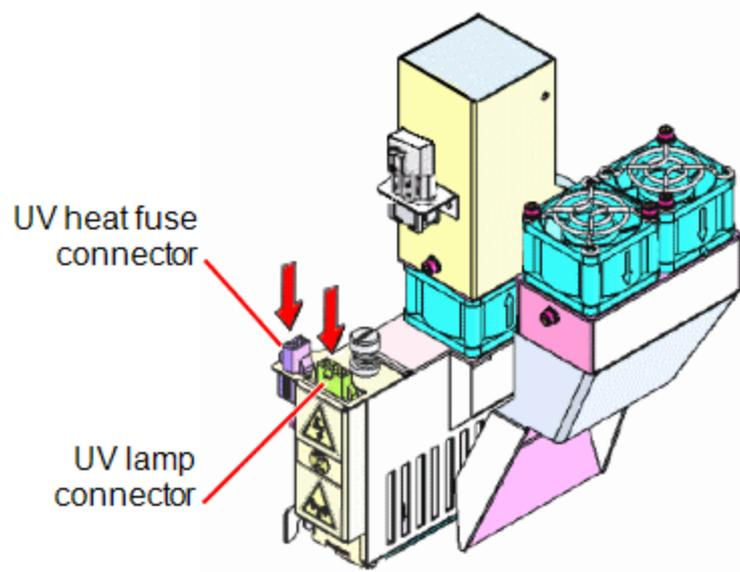

Figure 4-161 Connecting the UV lamp

20. In the wizard screen, confirm that you have replaced the UV lamp(s) and that the black strip is attached, then click **Next**.

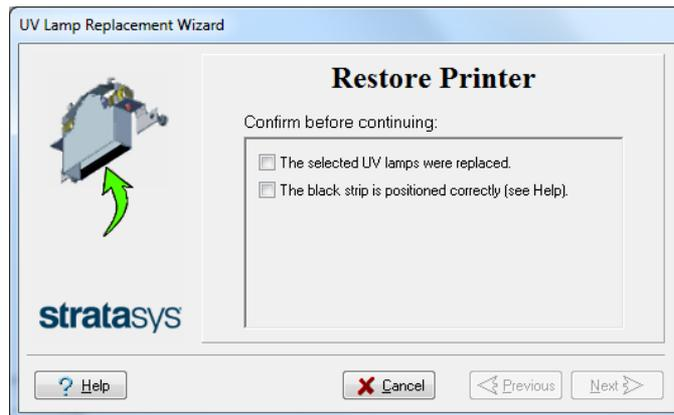

Figure 4-162 UV-installation confirmation

The wizard operates the UV lamps and checks if their power is within the acceptable range for each printing mode.

Note: The mode currently being checked appears in the lower-left corner of the printer interface.



Figure 4-163 Status during UV lamp check

After replacing a UV lamp, it is recommended that you calibrate its power for the various printing modes. The next screen allows you to continue to the UV Calibration wizard (see "Testing and Calibrating the UV Lamps" on page 4-73).

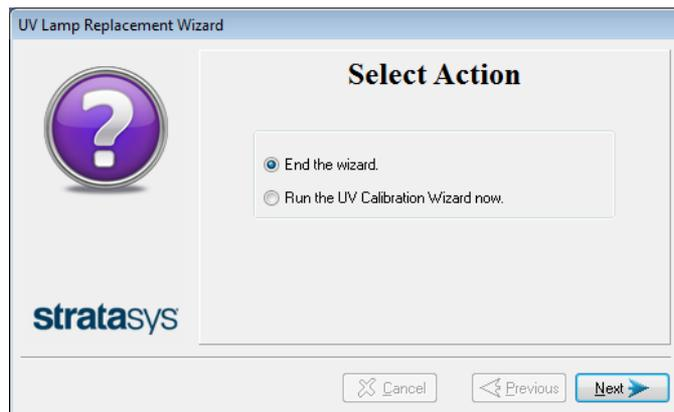

Figure 4-164 Calibration selection screen

Improving Color Uniformity of X-Walls

During the printing process, the alignment of the print heads can adversely affect the color uniformity of the part's X-walls. The non-uniformity is more noticeable when the part's left and right X-walls need to be matched after printing.

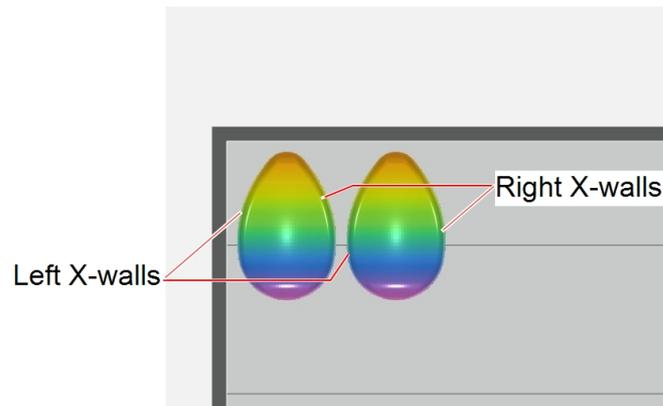

Figure 4-165 Color 3D print with matching walls

To achieve optimum color uniformity on left and right X-walls of the 3D print, after running the Head Alignment wizard, perform this wizard.



It is recommended to perform this wizard after replacing a print head.

The correction performed by this wizard can be activated or deactivated before each print job, as needed.

Note: This wizard is not applicable for High Quality mode.

In this procedure, you print a test transparency using the wizard, scan it on the digital scanner, load and analyze the scanned transparencies in an external Color Uniformity Utility, and enter the pixel correction values for each print head in this wizard.

To improve the color uniformity in 3D prints:

1. Prepare—

- disposable cleaning gloves (any clean, powder-free protective gloves)
- the scanner

Contact your Customer Support representative for the recommended scanner by Stratasys.

- a clean transparency (supplied in the Start-Up Kit)

Important: Do not use an unauthorized brand or type of transparency, as the results may not be accurate.

- the grid transparency (supplied in the scanner accessories kit)
- one A4-sized sheet of black plastic (supplied in the scanner accessories kit)

- Zyxax WaterShield™ for cleaning the transparency
- 90% isopropanol (IPA—*isopropyl alcohol*) or ethanol (*ethyl alcohol*)
- a computer running GrabCAD Print (preferably the computer that sends print jobs to the printer)
- the Color Uniformity Utility (a MATLAB® Environment may also be required if not installed).

Download this utility from the [Software Download](#) section on the Stratasys Support Center.

Important: The scanner platen and transparencies used in this procedure must be absolutely clean, without scratches, fingerprints or other marks. If necessary, use a suitable glass cleaner and cleaning cloth, and always wear gloves when handling these items.

Printing a Transparency

1. Start the Color Uniformity wizard from the *Options* menu.
2. Click **Next** to begin.
3. In the following screen, continue as follows:
 - To print a transparency sheet for analysis in the Color Uniformity Utility, select **Print transparency** and click **Next**.
 - To enter correction values that you obtained from an earlier analysis without printing a transparency, select **Enter correction values** and click **Next**.
 - To activate or deactivate the correction values that you have entered at an earlier time, select **Activate/Deactivate uniformity correction** and click **Next**.



Figure 4-166 Wizard process selection

4. Put on protective gloves.
5. Make sure that the build tray is empty and clean.
6. Place the blank transparency sheet flush against the rear and left edges of the tray (landscape orientation).



Figure 4-167 Fixing the transparency to the tray

7. Secure the transparency sheet with tape to the tray.
8. Using a clean cloth, wipe Zyvax Watershield over the entire transparency. Continue wiping until the transparency is dry.

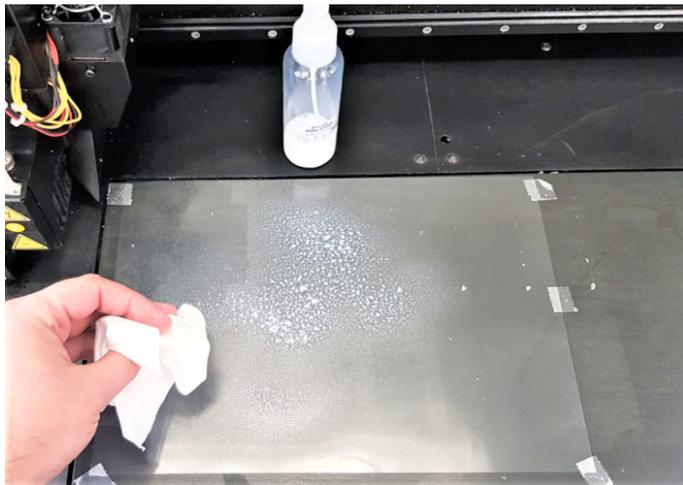

Figure 4-168 Cleaning the transparency with watershield

Important: If you do not apply Zyvax Watershield, the scan may fail and result in Missing Nozzles error. Also, you may need to perform more iterations.

9. In the following screen, confirm the items in the wizard screen, and click **Next**.

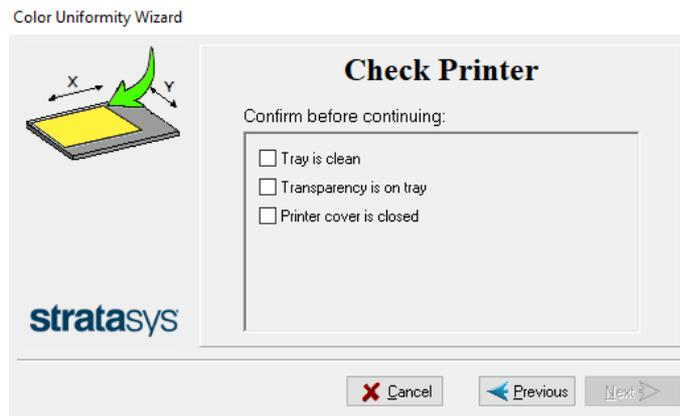

Figure 4-169 Confirming transparency readiness

A test pattern is printed on the transparency. This takes approximately 10 minutes.

10. When the printing is done, and click **Next**.
11. When the following screen appears, continue as follows:
- To enter the correction values, select **Enter the correction values now** and click **Next**. Continue below.
 - To enter the values at a later time, select **Exit wizard now. Enter correction values later** and click **Next**. The *Wizard Complete* screen appears. Click **Done** to exit.

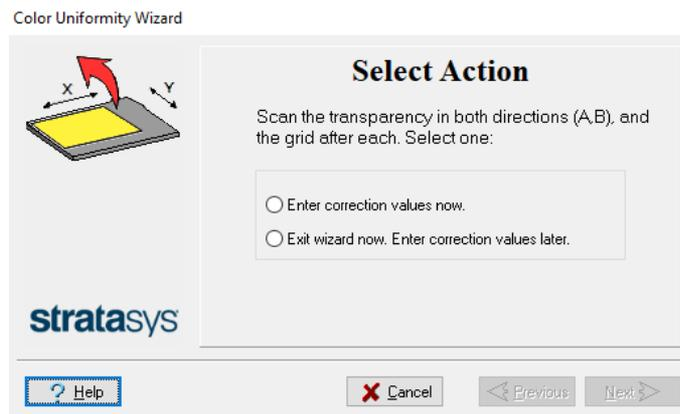

Figure 4-170 Continue or exit selection screen

This completes the first part of the process.

Scanning the Transparency

After printing the test pattern on a transparency, you scan it twice. In addition, you scan the reference (grid) transparency twice.

Use the scanner currently recommended by Stratasys.

The illustrations in this section show the Canon CanoScan LiDE 400 interface.

If you need to install the software for this scanner, download it from:

[https://www.canon.co.uk/support/consumer_products/products/scanners/lide_series/canoscan-lide-400.html?type=drivers&language=&os=windows%20%20\(64-bit\)](https://www.canon.co.uk/support/consumer_products/products/scanners/lide_series/canoscan-lide-400.html?type=drivers&language=&os=windows%20%20(64-bit))

For convenience, the scanner should be connected to the computer running GrabCAD Print.

To scan the transparency:

1. On the computer connected to the scanner, open the scanner utility.

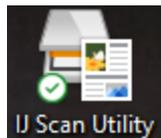

Figure 4-171 Scanner icon

2. In the opening screen, select **ScanGear**.

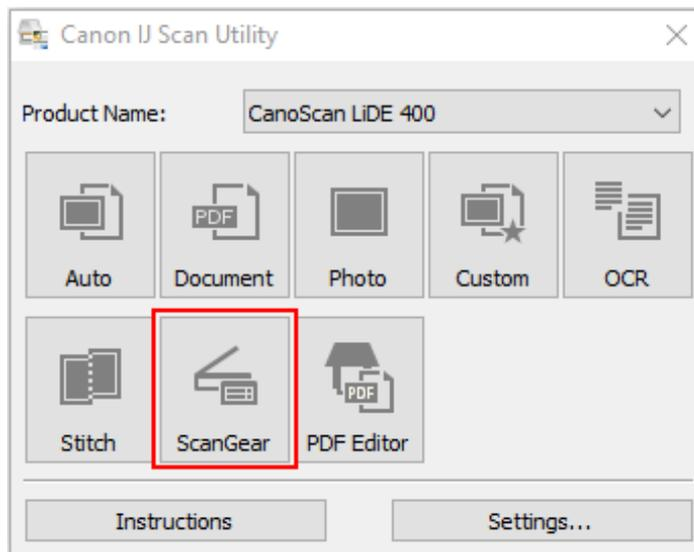

Figure 4-172 Scanning selection

3. Select the *Advanced Mode* tab.
4. Make sure that these settings are as follows:
 - Color Mode: **Color**
 - Output Resolution: **1200** dpi
 - All field under Image Settings: **None** or **OFF**

The screenshot shows the 'Advanced Mode' settings for a printer. The interface is organized into several sections:

- Favorite Settings:** A dropdown menu set to 'User defined'.
- Input Settings:**
 - Select Source: Platen
 - Paper Size: Full Platen
 - Color Mode: **Color** (highlighted with a red box)
 - Dimensions: 216.0 x 297.0 mm
- Output Settings:**
 - Output Resolution: **1200** dpi (highlighted with a red box)
 - Output Size: Flexible
 - Dimensions: 216.0 x 297.0 mm, 100%
 - Data Size: 409.80 MB
- Image Settings:** A list of dropdown menus, all set to 'None' or 'OFF' (highlighted with a red box):
 - Image Adjustment: None
 - Unsharp Mask: OFF
 - Descreen: OFF
 - Reduce Dust and Scratches: None
 - Fading Correction: None
 - Grain Correction: None
 - Gutter Shadow Correction: None

Figure 4-173 *Advanced Mode settings*

5. Place the test-pattern transparency face up on the scanner platen, with the arrows aligned with the black rail (under the glass), and the edge marked **'This Face Up - A'** along the bottom edge of the scanner glass (closest to you).

Make sure that the bottom edge of the transparency is at the border of the platen.



Figure 4-174 Placing the transparency on the scanner - side A

6. Place the A4 sheet of black plastic, glossy-side down, on top of the transparency. Do not move the transparency.
7. Close the scanner lid.
8. At the bottom of the scanner interface, click **Preview**.

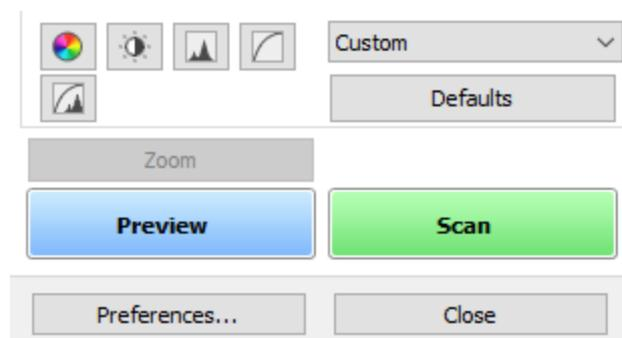

Figure 4-175 Scanner interface, showing *Preview* and *Scan* buttons

9. With the cursor, adjust the cropping frame (scan area) so that it surrounds the printed pattern shown below.

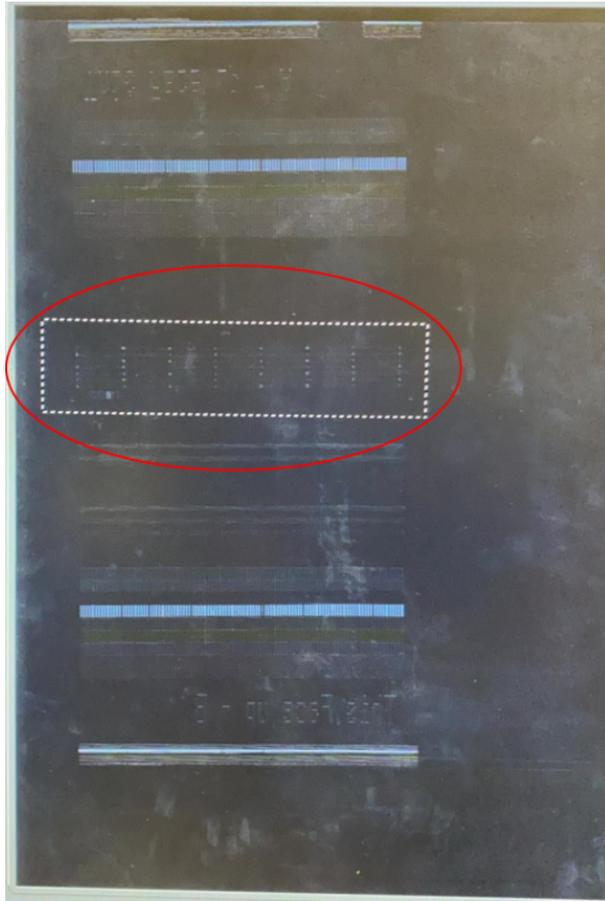

Figure 4-176 Adjusting the cropping frame (scan area)

10. Click **Scan**.

- When scanning is finished, select **Scan other images** in the dialog box and click **OK**.

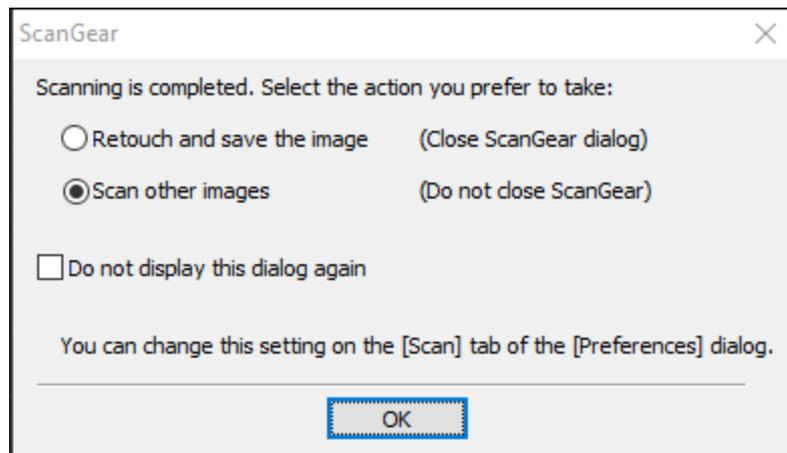

Figure 4-177 Selection after scanning the test pattern



If this dialog box does not appear, click **Preferences** (at the bottom of the interface) and in the *Scan* tab, select **Display the dialog to select next action**.

- Remove the transparency from the scanner, and place the reference (grid) transparency on the scanner platen, next to the bottom and left borders.
Note: Do not adjust the cropping frame (scan area). The scanning size must remain the same as for the test-pattern scan.
- Close the scanner lid.
- Click **Scan**.
- When scanning is finished, select **Scan other images** in the dialog box and click **OK**.
- Place the test-pattern transparency face up on the scanner platen, with the edge marked '**This Face Up - B**' along the bottom edge of the scanner glass (closest to you). See Figure 4-174 on page 4-114.
Make sure that the bottom edge of the transparency is at the border of the platen.
- Place the A4 sheet of black plastic, glossy-side down, on top of the transparency. Do not move the transparency.
- Close the scanner lid.
- Repeat steps 8–14.

20. When scanning is finished, select **Retouch and save the image** in the dialog box and click **OK**.

Important: Save the images as JPG files.

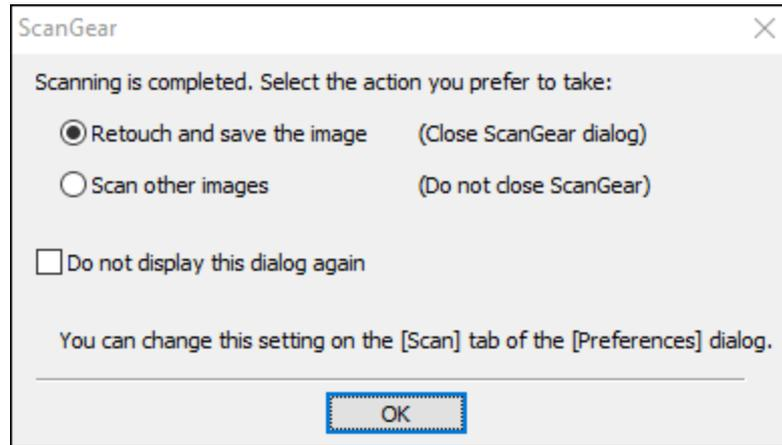

Figure 4-178 Selection after scanning the reference transparency

21. Save the scanned files in a convenient folder on your computer. Next, you load these files to a dedicated utility for analysis.

Analyzing the Transparencies

After scanning the test pattern and the reference grid, you analyze them in the Color Uniformity Utility, and the pixel correction values are calculated.

To analyze the scanned transparencies:

1. Open the Color Uniformity Utility installed on the GrabCAD Print computer.
2. Click *Load Images* and double-click one of the scanned images in the folder. You can select any one of the JPG images. Once you select an image, the utility uploads all four (4) JPG images of the scans you saved.

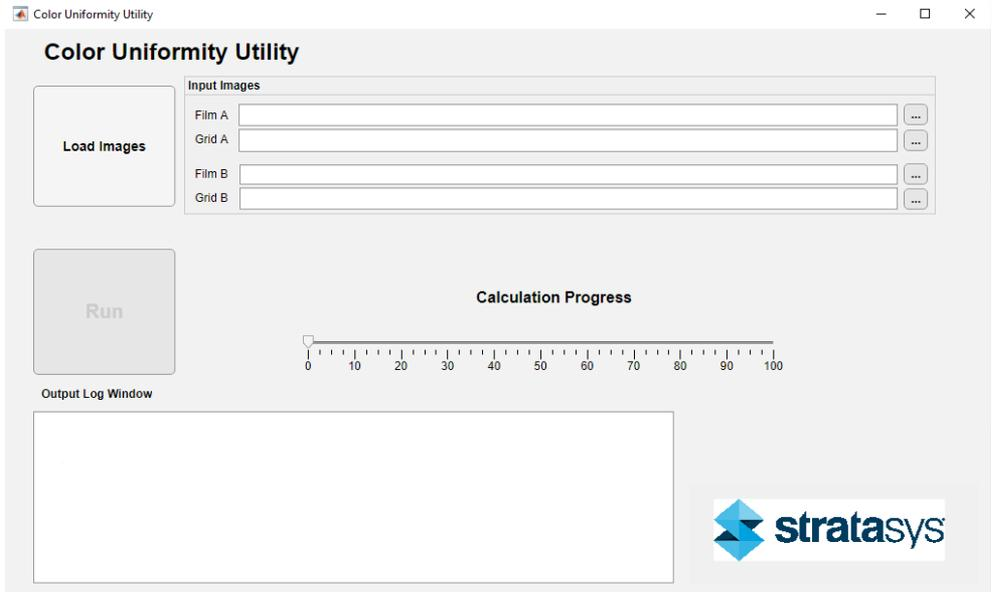

Figure 4-179 Color Uniformity Utility screen

3. Click **Run** to analyze the files.
4. When the analysis is complete, the results are displayed in the following screen.

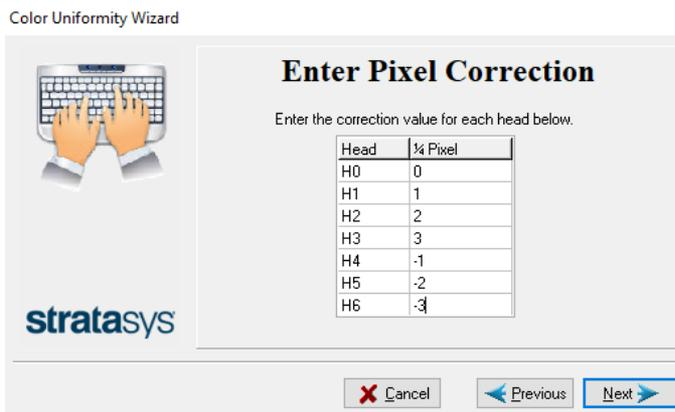
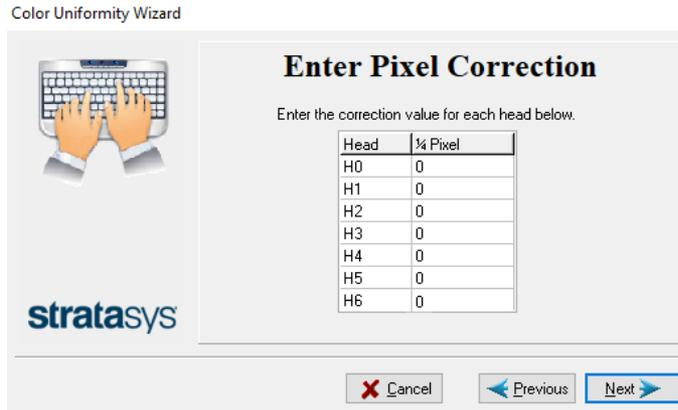

Figure 4-180 Enter Pixel Correction screen in utility

The results file is saved in the same folder as the scanned JPG files. This folder also contains a log file and the analysis of each scan.

- On the printer, in the following wizard screen, enter each of the correction values that appear in the utility in the $\frac{1}{4}$ Pixel column.

Color Uniformity Wizard



Enter Pixel Correction

Enter the correction value for each head below.

Head	$\frac{1}{4}$ Pixel
H0	0
H1	0
H2	0
H3	0
H4	0
H5	0
H6	0

stratasys

Cancel Previous Next

Figure 4-181 Enter Pixel Correction screen in wizard

- Click **Next**.
- Save the corrections.
- In the *Wizard Completed* screen, click **Done**.

Once the correction values are saved, a check mark appears near the wizard in the *Wizards* menu, as shown below. This indicates that the wizard is activated and the values are in use.

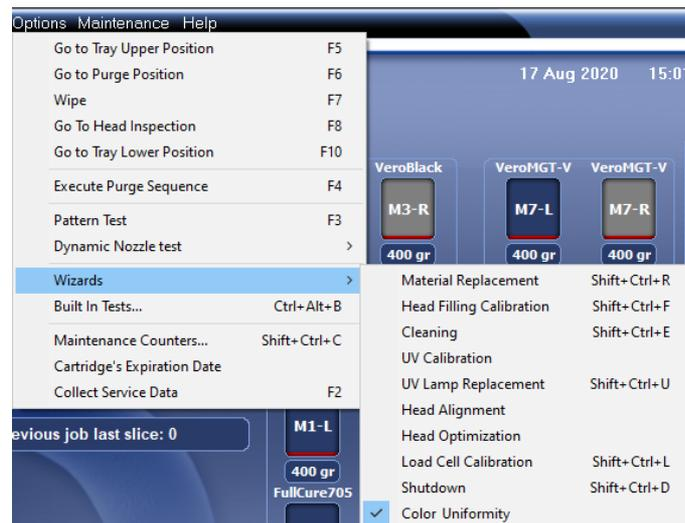

Figure 4-182 Color Uniformity wizard activated in the *Wizards* menu

Dynamic Nozzle Test

Perform the Dynamic Nozzle Test if you suspect that poor quality in 3D prints is caused by clogged or faulty nozzles in the print heads—even if this is not indicated by the Pattern Test.

The Dynamic Nozzle Test prints eight (8) samples on the build tray, which you can then visually inspect. Printing the samples takes about 20 minutes.

To run the Dynamic Nozzle Test:

1. Make sure that the build tray is clear (empty).
2. From the *Options* menu, select **Dynamic Nozzle Test**.

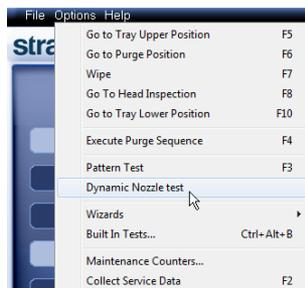

Figure 4-183 Selecting *Dynamic Nozzle Test* from the *Options* menu

3. When the samples are printed, check if they have visible gaps.



Figure 4-184 *Dynamic Nozzle Test* samples

- In the left sample shown above, there are no gaps.
- In the right sample shown above, there are only two gaps, which is acceptable.

Many gaps in the sample indicates that many nozzles in the print head are not functioning. This might indicate the need to replace the defective head. In this case, consult with your Stratasys service provider.



Samples printed from certain model materials in this test might not be completely cured. Because some of the material remains in liquid (or semi-liquid) state, you cannot check for gaps in these samples. Do not be concerned that liquid resin remains on and around these samples.

Built-in Tests

The printer application contains a suite of tests for regularly checking the hardware and software, and for troubleshooting.

Because running the tests affects the operation of the printer, you can only open the Built-in Tests interface when the system is not printing.

The test suite features:

- The organization of printing-related tasks in categories:
 - Communications
 - Data cards
 - Temperatures
 - Voltages
 - Encoder repeatability
 - Print-head heating
 - Print-head filling
- A clear display of test results and the source of any failures, enabling you to determine if printing is possible or worthwhile.
- The ability to monitor test results for specific components.
- Troubleshooting tips.

Running these tests can help identify problems in the printer hardware and software. A large number of hardware defects (or near-defects) warns you of possible printing problems, either for current or future jobs.



Stratasys recommends running the built-in tests in the following cases:

- as a routine test, once every two weeks
- as a system check, before major (long) jobs
- as needed, for troubleshooting

To open the **Built-in Tests** screen, do one of the following:

- From the *Options* menu, select **Built-In Tests**.
- Press **Ctrl+Alt+B**.

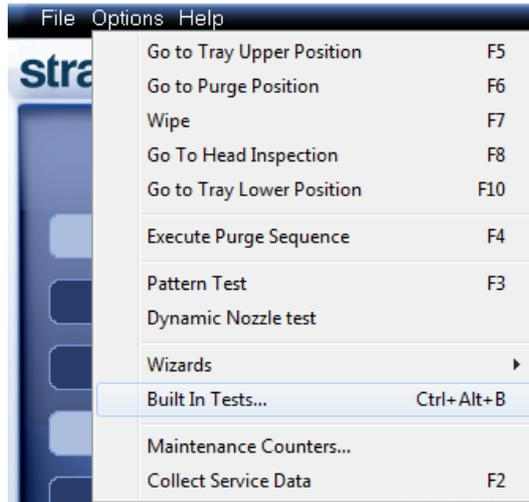

Figure 4-185 Selecting *Built-In Tests* from the *Options* menu

The *Built In Tests* screen lists pre-configured tests, grouped by component categories. In this screen, you select and run tests, and the results are displayed.

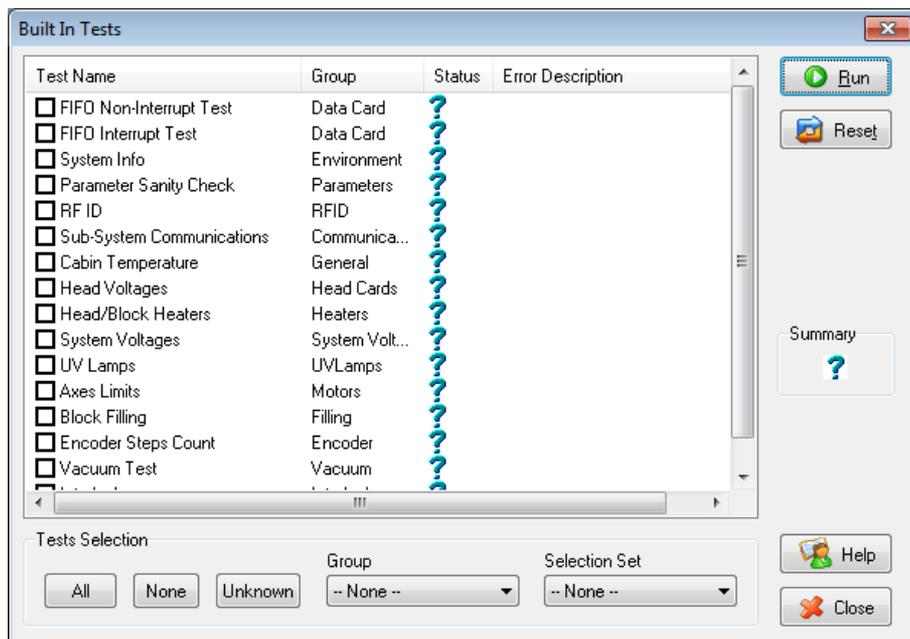

Figure 4-186 *Built In Tests* screen

Test List

Test Name

This column lists all of the tests, together with selection check boxes.

Click the check boxes to select the tests you want to run. To remove a selection, click the check box again. To quickly select all of the tests in a component category, use the *Group* drop-down list at the bottom of the screen.

Group

This column shows the component categories for each test.

This tells you which tests are run when selecting a category from the *Group* drop-down list at the bottom of the screen.

Status

This column shows the results of each test after you run it:

- ✓ Test successfully completed.
- ✗ Test failed. (Double-click on a failed test's line to review the failure details.)
- ? Unknown results. (The test has not been run yet.)

Test Selection Area

In the *Test Selection* area, at the bottom of the screen, you can quickly select or de-select tests by their characteristics:

All	Click to select all of the tests in the list.
None	Click to de-select all of the tests in the list.
Unknown	Click to select all test that have not been run yet (Status = ?).
Group	Use this menu to select tests by component category.
Selection Set	Use this menu to select a pre-configured set of tests to run at specified times (computer startup, before printing, etc.).

Running Built-in Tests

To run the selected tests:

- Click  .



After you run a test, the *Save* and *View* command buttons are added to the *Built In Tests* screen.

Test Results

To save and view a report of all tests:

- Use the Save and View command buttons.

Command Buttons



Click the command buttons, on the right side of the screen to perform the following operations:

Run

Click to run the selected tests.

Reset

Click to clear previously run tests. This returns the status of each test to *Unknown (?)*.

Save

Click to save a report that summarizes the tests run. The report is saved as an HTML file. You can save any number of reports for the tests you run; the name of the file saved is **BITReport [date][time].htm**. By default, these files are saved in the printer installation folder, but you can save it in any other folder.

View

Click to display the latest test report that you saved. (You can view other test reports by opening the relevant files in your Web browser. To do so, open Windows Explorer, and double click the *BITReport* file.)

Close

Click to close the *Built-in Tests* screen.

Summary

On the right side of the screen, a symbol represents the combined results of all the tests run, using the symbols from the *Status* column.

- ✓ All tests successfully completed.
- ✗ At least one test failed.
- ? Not all tests performed.

Test Descriptions and Troubleshooting

The following table lists the name of each test in the Built-in Tests suite, together with its description and a possible reason for its failure. If you need assistance, contact your Stratasys service provider.

Test Name	Description	Possible Reason for Failure
FIFO Non-Interrupt/ FIFO Interrupt	<ul style="list-style-type: none"> • Tests the data queue in the DATA PCI card. • Tests the Windows interrupt. 	<ul style="list-style-type: none"> • If both FIFO tests fail: Faulty DATA_PCI card. • If only the FIFO Interrupt test fails: Faulty Windows interrupt.
System Info	<p>Compares the following parameter values with the minimum requirements.</p> <ul style="list-style-type: none"> • physical memory • available memory • free space on disk • monitor resolution 	Failure of RAM memory allocation in the printer computer.
Parameter Sanity Check	Compares the values of all printer parameters (in cfg files) to the required values.	One or more of the printer parameters is not within the required range. Details appear in the BIT report.
RFID	Verifies the presence of RFID tags on material cartridges, and tests them (by writing data to the tag and then reading it).	<ul style="list-style-type: none"> • Faulty RFID reader. • Faulty RFID reader power supply. • Faulty or misaligned RFID tag. • High level of electromagnetic noise around the RFID tag.
Sub-System Communications	Tests communication between printer components.	<ul style="list-style-type: none"> • Disconnected communications cable. • Faulty cable.
Cabin Temperature	Tests the temperature level in the build-tray area.	<ul style="list-style-type: none"> • Faulty temperature sensor (OHDB). • Failure of exhaust fan. • Clogged exhaust filter.

Test Name	Description	Possible Reason for Failure
Head Voltages	Checks the control of voltages supplied to the print heads.	Faulty print-head driver card(s).
Head/Block Heaters	Tests the heaters in the print heads and in the print-block body.	Faulty heaters or thermistors.
System Voltages	Checks if the following voltages are within 5% of the required voltage: <ul style="list-style-type: none"> • 40V to the print heads by the VPP power supply • 12V to the height thermistors by the VDD power supply 	<ul style="list-style-type: none"> • VPP power supply: Faulty head driver. • VDD power supply: Faulty height thermistor.
UV Lamps	Tests each UV lamp at the High Quality power level.	<ul style="list-style-type: none"> • Faulty UV lamp. • Faulty UV power supply. • Disconnected UV cable.
Axes Limits	Tests the hardware and software limits of all axes.	Faulty hardware sensors. Wrong <i>Max Position</i> parameter.
Block Filling	Analyzes the thermistor readings when the block is full and when it is empty.	Faulty thermistor.
Encoder Steps Count	Tests the encoder's reliability by comparing readings from multiple runs along the X-axis.	Misaligned or faulty encoder.
Vacuum Test	Tests the vacuum level in the print block.	<ul style="list-style-type: none"> • Faulty vacuum sensor. • Vacuum leakage. • Wrong parameters.
Interlock	Tests the interlock in the printer cover.	<ul style="list-style-type: none"> • Failure of interlock mechanism. • Faulty latch. • Disconnected cable.
Version Tests	Checks the compatibility between the software and component firmware versions.	

Replacing the Waste Container

Printer waste contains partially cured polymeric material, collected during normal operation and maintenance of the printer. For safety and environmental reasons, this material is kept in a special leak-proof, disposable container.

The container has a capacity of 10 kilograms of waste material—usually enough for several months of printer use. The printer application displays a warning message when there are 9 kilograms of material in the container, and stops the printing when the net weight reaches 9.5 kilograms. Above 9 kilograms, the software does not allow you to start a printing job or activity until you replace the waste container.

You can monitor the weight of the waste container in the Printer Indicators display in the printer interface. You can also visually inspect the level of waste in the container. To access it, see page 4-128.

To monitor the waste weight (and other indicators) in the printer:

- In the main printer interface screen, click the display toggle to view the printer indicators.

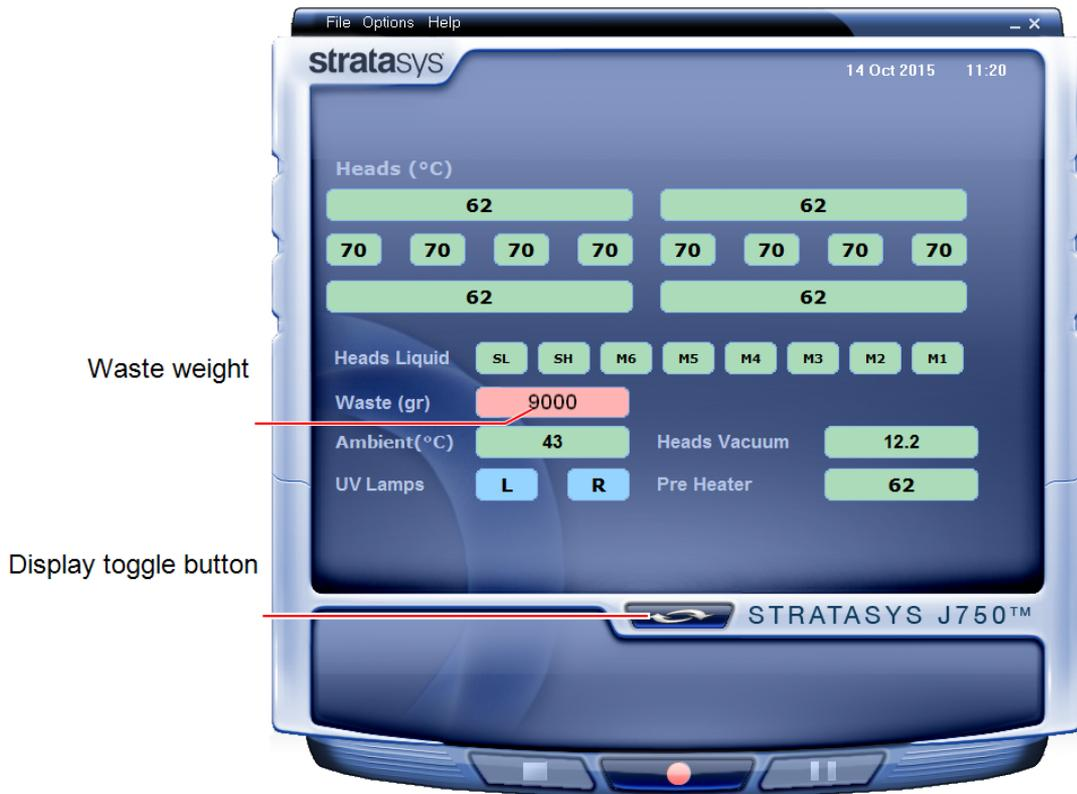

Figure 4-187 Printer interface, showing waste weight (red background indicates operator alert)

The waste container consists of a plastic container inside a cardboard box. You typically dispose of the entire waste container—including the box. Therefore, you must assemble a new box and insert a new plastic container before you can install it in the printer.



Replacement boxes, plastic containers, and sealing caps are supplied in the printer start-up kit and in the preventive-maintenance kit.

To prepare a new waste container:

1. Assemble the cardboard box, making sure to punch out the perforated sections.
2. Place a new plastic container into the box.
3. Close the new waste container box.
If necessary, use tape to hold it closed.



Caution:

Do not replace the waste container box during a printing job. Waste container replacement during printing might cause the printing process to stop or a severe print failure.

To replace the waste container:

1. Locate the door on the lower-left side of the printer.
2. Push in the top-center of the door to release the latch and open the door.



Figure 4-188 Accessing the waste container

3. Carefully slide out the waste container to remove it from the printer.
4. Place the new waste container next to the full container.
5. Unscrew the cap securing the waste drain tube and connect it to the new container.
6. Close the full container with the cap supplied with the new waste container.

7. Position new the waste container in the printer.

Note: Make sure that the waste drain tube is not crimped or twisted, and that it is not pinched by the container.

8. Close the waste compartment door.



Dispose of the full waste container in accordance with environmental and safety requirements.

Cleaning the Exterior Panels

The painted exterior plastic panels of the printer has a durable finish, offering excellent chemical resistance to common cleaning materials. Follow the recommendations below when cleaning these areas of the printer.

Acceptable Cleaning Agents

- mild soap solution
- common household cleaners and window cleaners
- common commercial and industrial detergents, 5% solution in water
- alcohol (ethanol, isopropanol), 10% to 40% solution in water

Wipe the exterior of the printer, using a soft cloth moistened with the cleaning solution.

Unacceptable Materials

- industrial solvents
- cleaning agents containing hydrocarbons, ketones, esters and lacquer thinners
- spray disinfectants
- abrasives and agents which could wear away the panel finish

Cleaning the UV Screen

The transparent section of the cover is made of strong, acrylic material that screens out harmful UV radiation. Use extreme care when cleaning it to prevent the appearance of scratch marks.



Caution

Do not use abrasive cleaners or cleaning fluids containing ammonia, alcohol, acetone, benzine, carbon or tetrachloride. These materials can cause permanent damage to the surface.

To clean the UV screen:

1. Blow off surface dust.
Do **not** wipe the surface to remove dust; this might scratch the surface.
2. Prepare a 1-percent solution of mild dish-washing soap in water—about two teaspoons (10 ml) in a liter of water.

Note: While soapy water is effective for cleaning, commercial products are also available for cleaning acrylic surfaces (for example, Novus® and Brilliance®). These products give the surface antistatic, smudge and scratch-resistant properties.

3. Soak a micro-fiber cloth in the solution.
Do not use paper towels, which can cause scratch marks.
4. Thoroughly wet the surface with the cloth. Do not wipe!
5. Rinse the cloth with clean water.
6. Absorb the solution from the acrylic surface with the cloth, without applying pressure.
7. If necessary, repeat to remove any remaining marks, or apply clean water to rinse the surface.
8. If the surface is still wet, you can dry it with a clean, micro-fiber cloth by gently wiping in one direction.



If convenient, you can apply the cleaning solution and water to the acrylic surfaces with a spray bottle instead of with the cloth.

5

Handling Printed Models

Removing 3D Prints After Printing	5-2
Removing the Support Material	5-2
Removing Support by Hand	5-3
Removing Support with Water Pressure	5-3
Removing SUP705/705B with Caustic Soda	5-4
Removing SUP706/706B with Caustic Soda and Sodium Metasilicate ..	5-4
Post-Printing Treatment	5-5
Photobleaching for Transparent 3D Prints	5-5
Storing 3D Prints	5-5

Removing 3D Prints After Printing

When printing is completed, you should allow the 3D prints to cool as much as possible before handling them. If additional 3D prints do not have to be produced on the printer, it is best to let the 3D prints cool in the printer, with the cover closed, as long as possible.

If the printer must be used to produce additional 3D prints as soon as possible:

1. Let the 3D prints cool on the build tray for at least 10 minutes.
2. Put on protective gloves .



Warning:

Wear protective gloves when handling 3D prints before they are washed.

3. Very carefully, remove the 3D prints from the tray with a scraper or spatula (supplied in the tool kit), taking care not to pry or bend the 3D prints.



Warning: Sharp Object Hazard

Directing the scraper toward body parts can result in injury. When removing the parts, always push the scraper away from you.

4. Place the 3D prints on a flat surface, and cover them with a cardboard box or paper hood.
This allows them to cool slowly and evenly.
5. Let the 3D prints cool for several hours.

Removing the Support Material

After the 3D prints have cooled, the support material must be removed. This can be done by different methods, depending on the type of support material, the size of the 3D print, how delicate it is, the amount and location of the support material, and other factors. The methods described in this section refer to removing general-purpose support materials from 3D prints, for most printing applications. Use this information as a guide, and adapt the methods (or a combination of them) for cleaning your 3D prints.



For special printing applications, including Digital Anatomy models, refer to documents on the [Stratasys Support Center](#) or consult a Stratasys 3D printing expert.

The following types of support material available:

- SUP705/705B, a gel-like support material.
- SUP706/706B, an easily removed support material that dissolves in a solution of caustic soda and sodium metasilicate.

The support material can be removed from 3D prints using the following methods, in this order:

1. by hand
2. water pressure (in a suitable cleaning unit)
3. SUP706/706B: 2% caustic soda and sodium metasilicate solution.
SUP705/705B: 1% caustic soda solution (recommended for a smooth finish)

Removing Support by Hand

While wearing protective gloves, break away excess support material on the outside of the 3D print. For delicate 3D prints, use a toothpick, pin or small brush after dipping the 3D prints in water.

- For SUP705/705B, after breaking away excess support material, soak the 3D print in a 1% caustic soda solution (see "Removing SUP705/705B with Caustic Soda" on page 5-4).
- For SUP706/706B, after breaking away excess support material, soak the 3D print in a 2% caustic soda and sodium metasilicate solution (see "Removing SUP706/706B with Caustic Soda and Sodium Metasilicate" on the next page).

Removing Support with Water Pressure

For most 3D prints, the most efficient way to remove support material is by using a high-pressure water jet. One suitable system is the Balco WaterJet cleaning unit. This device is marketed by Stratasys.

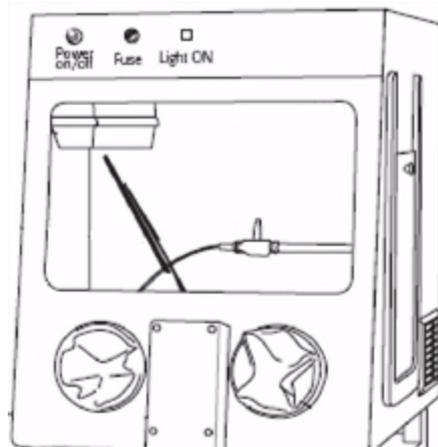

Figure 5-1 Balco WaterJet Cleaning Unit

To clean a 3D print using this device, you manipulate it and the water using the built-in, waterproof sleeves. A pump turns ordinary tap water into a high-pressure jet. A wiper keeps the window clear.



Use caution when cleaning delicate 3D prints with high-pressure water systems.

Removing SUP705/705B with Caustic Soda

Soak 3D prints in a 1-percent solution of caustic soda (sodium hydroxide) to remove support material from difficult-to-reach areas and to give the 3D print a smooth, clean finish. The amount of time you soak the 3D prints in the solution depends on how delicate it is and how much support material needs to be removed, but it is typically between half-an-hour and several hours. In any case, you should remove as much support material as possible before the caustic soda treatment, and rinse the it thoroughly (with a water jet) afterwards.



Warning

Caustic soda may cause chemical burns, scarring and blindness. Mixing it with water generates heat that could ignite other materials. Never pour water into caustic soda. When diluting the solution, always add caustic soda to water. Take adequate safety precautions; always use nitrile gloves when handling caustic soda and 3D prints soaked in it.

Removing SUP706/706B with Caustic Soda and Sodium Metasilicate

Soak 3D prints in a 2-percent solution of caustic soda (sodium hydroxide) and sodium metasilicate (Na_2SiO_3) to remove support material. The amount of time you soak the 3D prints in the solution depends on how delicate it is and how much support material needs to be removed. Rinse the 3D print thoroughly under running water afterwards.



SUP706/706B will dissolve into the caustic soda and sodium metasilicate solution and saturate it, reducing its effectiveness. Replace the solution when the support material reaches 15% of the solution (after approximately one month of average use).



Warning

Caustic soda may cause chemical burns, scarring and blindness. Mixing it with water generates heat that could ignite other materials. Never pour water into caustic soda. When diluting the solution, always add caustic soda to water. Take adequate safety precautions; always use nitrile gloves when handling caustic soda and 3D prints soaked in it.

Post-Printing Treatment

Post-printing treatment is recommended for 3D prints with several special-purpose materials or for special applications. Recommendations for treating and finishing 3D prints after printing are described in the Best Practices for the desired printing material available on the [Stratasys Support Center](#).

Photobleaching for Transparent 3D Prints

3D prints fabricated with clear materials, such as VeroClear (RGD810) and VeroUltra Clear (RGD820) have a slight yellow tint when removed from the printer. This is especially true for 3D prints with a glossy finish. The yellow tint fades naturally over time, but you can greatly accelerate this process by using a suitable photobleaching treatment. This involves exposing 3D prints to intense light immediately after printing.



Photobleaching methods and instructions are described in the Best Practices for the relevant clear material. These are available on the [Transparent materials page on the Stratasys Support Center](#).

Refer to the Best Practices for:

- VeroClear RGD810
- VeroUltra Clear RGD820

Storing 3D Prints

3D prints are cured as they are printed, making them safe and stable for a long time. However, proper storage conditions are necessary to prevent deforming.

- Keep 3D prints at room temperature and in a low-humidity environment.
- Do not expose 3D prints to direct sunlight and other heat sources.